

Spicer® CTIS (Central Tire Inflation System)



SPICER®
Drivetrain Products

Troubleshooting Guide

AXTS-0015

March 2017

General Information

General Information

The description and specifications contained in this service publication are current at the time of printing. Dana reserves the right to discontinue or to modify its models and/or procedures and to change specifications at any time without notice.

Any reference to brand names in this publication is made simply as an example of the types of tools and materials recommended for use and should not be considered an endorsement. Equivalents, if available, may be used.

Important Notice

This symbol is used throughout this manual to call attention to procedures where carelessness or failure to follow specific instructions may result in personal injury and/or component damage.

Departure from the instructions, choice of tools, materials and recommended parts mentioned in this publication may jeopardize the personal safety of the service technician or vehicle operator.

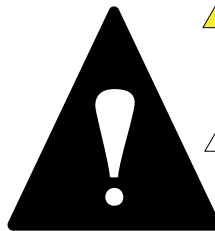

 **WARNING:** Failure to follow indicated procedures creates a high risk of personal injury to the servicing technician.

 **CAUTION:** Failure to follow indicated procedures may cause component damage or malfunction.

 **IMPORTANT:** Highly recommended procedures for proper service of this unit.

Note: Additional service information not covered in the service procedures.

TIP: Helpful removal and installation procedures to aid in the service of this unit.

[Always use genuine Spicer replacement parts.](#)

Note: Interactive PDF functions may not work correctly unless viewed using the free [Adobe Acrobat Reader](#).

Table of Contents



General Information (Important)

| | |
|---------------------------------------------------------|---|
| Central Tire Inflation System (CTIS) Key Features | 1 |
| Depressurized Control Lines..... | 1 |
| Air Brake System Priority | 1 |
| Run Flat Function | 1 |
| Diagnostic Capability | 1 |
| Speed/Pressure Control and Warning..... | 1 |
| Manual Tire Inflation, Deflation, Measurement | 1 |
| Self-Diagnostic and Auto Shut-Down | 1 |
| Component Description..... | 2 |
| General Troubleshooting Tips..... | 3 |
| Basic Operation and Causes for Issues | 4 |
| Components and Likelihood to Cause a Failure | 4 |
| Simplified System Schematic..... | 6 |

Operator Instructions

| | |
|---------------------------------------------------|----|
| Flange or Panel - Operator Controls | 7 |
| *Warning Signals* for Flange and Panel ECU's..... | 9 |
| Driver Display Module—Operator Controls..... | 11 |
| Driver Display Module (DDM) - Warnings | 12 |

Diagnostics

| | |
|-----------------------------|----|
| Test Equipment..... | 13 |
| PC Diagnostics | 14 |
| Handheld Tester..... | 15 |
| Pressure Gauge | 15 |
| Multimeter | 15 |
| Service Codes Summary | 16 |
| Troubleshooting Tips | 22 |

Service Codes

| | |
|----------------------------------------------------------------------------------------------|----|
| (Codes 26, 27) - 5 Flashing Lights or DDM – Dashes “--” | 23 |
| (Code 31) - 5 Flashing Lights or DDM – Dashes “--” | 25 |
| (Code 31) - Pressure Switch | 26 |
| (Code 32) - 5 Flashing Lights or DDM – Dashes “--” | 27 |
| (Code 32) - Low Air Supply | 28 |
| (Code 34) - 5 Flashing Lights or DDM – Dashes “--” | 29 |
| (Code 34) - PCU Sensor | 30 |
| (Code 35) - 5 Flashing Lights or DDM – Dashes “--” | 31 |
| (Code 35) - Atmospheric | 32 |
| (Code 14) - 5 Flashing Lights or DDM – Dashes “--” | 33 |
| (Code 14) - Deflate Trend | 34 |
| (Codes 36, 37) - 5 Flashing Lights or DDM – Dashes “- -” and or “Check Tires” Solid | 35 |
| (Codes 36, 37) - Inflate Trend..... | 36 |
| (Codes 44, 45) - 4 Flashing Lights or CHECK TIRES Flashing | 37 |
| (Codes 44, 45) - Tire Leak (Imbalance) | 38 |
| (Codes 41, 42) - 4 Flashing Lights or CHECK TIRES Flashing | 39 |
| (Codes 41, 42) - Tire Leak (Confirm) | 40 |
| (Codes 23, 24) - 2 Terrain Lights on Solid or DDM – Dashes “- -” | 41 |
| (Codes 23, 24) - Between Modes | 42 |
| (Codes 11, 12, 16) - 2 Terrain Lights on Solid or DDM – Dashes “- -” | 43 |
| (Codes 11, 12, 16) - Deflate Signal..... | 44 |

| | |
|-----------------------------------------------------------------------------------------------------|----|
| (Codes 51, 52, 54, 55, 56) - No Terrain Lights or DDM – Dashes “- -” | 45 |
| (Codes 51, 52, 54, 55, 56) - PCU Solenoid..... | 46 |
| (Code 17) - No Terrain Lights or DDM – Blank Display | 47 |
| (Code 17) - Power | 48 |
| (Code 75) - DDM – Dashes “- -” | 49 |
| (Code 75) - Display Control Communications | 50 |
| Sequentially Flashing Lights or “dL” displayed on DDM | 51 |
| Configuration DL/Reset | 52 |
| (Codes 18, 76, 77) - Solid Warning Lamp or Solid “OVER SPEED” | 53 |
| (Code 18, 76, 77) - Speed Signal | 54 |
| (Codes 47, 48) - 5 Flashing Lights or DDM – Dashes “- -” | 55 |
| (Codes 47, 48) - Supply Tank Sensor..... | 56 |
| (Codes 53, 57, 58, 67, 68) - No Indication or DDM – Dashes “- -” (Implementation Specific) | 57 |
| (Codes 53, 57, 58, 67, 68) - Miscellaneous Output | 58 |
| (Codes 61, 62) - No Indication | 59 |
| (Codes 64, 65) - No Indication | 60 |

Service Guidelines

| | |
|------------------------------------------|----|
| General Information..... | 62 |
| Air Filter Change..... | 63 |
| Wheel Valve with Tire Hose | 63 |
| Integrated Wheel Valve..... | 63 |
| Connector Illustrations | 64 |
| M-9XX Wiring Diagram | 65 |
| Flange Mount Wiring Diagram | 66 |
| Panel Mount Wiring Diagram | 67 |
| Chassis ECU with DDM Wiring Diagram..... | 68 |
| Chassis ECU with DDM Wiring Diagram..... | 69 |
| Configuration Options | 70 |

General Information

Central Tire Inflation System (CTIS) Key Features

The Dana CTI System features driver control of the vehicles tire air pressures through:

- Push button operation or smart dash control
- Air braking priority with supply pressure sensing
- Vehicle speed sensing and safety response
- Self-diagnostics and PC troubleshooting
- (Optional) independent front and rear operation
- (Optional) load selection and messaging

Depressurized Control Lines

The only time the system is pressurized is when changing tire pressures or during pressure checks. Wheel valves isolate the tires from the rest of the system when idle.

Air Brake System Priority

A pressure switch or transducer installed in the supply tank controls the CTIS usage of air. This protects the vehicle air brake systems by helping to maintaining a safe level of air pressure at all times.

Run Flat Function

The CTIS normally checks tire pressures at 15 minutes intervals. If tire damage is detected, the system will activate the Auto Run Flat feature. This mode reduces the pressure check intervals to 15 seconds, helping to ensure that the tire will remain inflated despite minor damage and warn the operator if the tire is losing too much air.

Run Flat Definition (Manual)

Pressing the “RUN FLAT” button once during normal system operation puts the system in Run Flat Mode for 10 minutes and causes several things to happen (used for expected tire damage, or to clear some “4 light” faults).

1. The run flat light will flash along with the selected terrain light.
2. Pressure checks will occur every 15 seconds until run flat times out (10 minutes).
3. Frequent use of run flat may over inflate the tires.

Note: The “Run Flat” feature is not available in manual selection on the DDM/Switch interface. See [page 11](#).

Run Flat Definition (Automatic)

If a severe tire pressure imbalance is detected during a pressure check, the system will automatically turn on the Run Flat feature. This condition will remain active until the selected tire pressure setting is achieved. At this point, if the imbalance is corrected the run flat mode will stop, but if the severe imbalance is still present, a fault will become active.

Diagnostic Capability

The Dana CTIS provides for easy troubleshooting using PC-based or industry standard tools. Personal computer-supported diagnostics improve troubleshooting and reduce maintenance time. The diagnostics provide for manual control of CTIS test sequences and displays active and historic service codes. Faults and status are broadcast on the vehicles CAN bus at regular intervals (as available).

Speed/Pressure Control and Warning

If vehicle speed exceeds the maximum allowable speed for a given setting, a warning indicator is activated to alert the operator. If speed is not reduced, the system automatically inflates the tires to the higher appropriate pressure.

Manual Tire Inflation, Deflation, Measurement

An optional valve stem may be included on the wheel valve and can be used for manual inflation, deflation or measurement of tire pressures.

Self-Diagnostic and Auto Shut-Down

The Dana CTIS provides self-diagnosis during operation. If the system detects a problem, it will display a series of flashing lights on the Electronic Control Unit (ECU) or (DDM) panel to alert the driver. If necessary, it may close the wheel valves and shut down or continue to inflate a damaged tire. Faults and status are broadcast on the vehicles CAN bus at regular intervals (as available).

General Information

Component Description

Wheel Valve (WV)

One (WV) is located at each wheel end. Dual wheels are pneumatically tied together. Each wheel valve acts like check valve blocking the tire pressure when the system is at idle. When the system is inflating or deflating, air passes through the WV in opposite directions. When the valve is closed, the air pressure in the rest of the system is vented to atmosphere. An optional Schrader valve can also be included for manual inflation and measurement of the tire pressure.

Quick Release Valve (QRV)

The Quick Release Valve (one per axle) receives pneumatic signals from the PCU for inflation, deflation, and venting. During deflations and venting, air exhausts out the vent port. This port can be connected to a hose and routed to a protected area allowing for deep water fording.

Air Transport Valve (ATV) - Optional

Air Transport Valves (ATV): Were used exclusively on older FMTV steer wheel ends between the tire hose and Schrader valve. These valves are manually be opened to lower the front tire pressures below the system limits allowing for loading of the vehicle onto transport aircraft.

Load Selection/Sensing - Optional

Some CTI systems make use of either a user-selectable load setting or can respond automatically to a load signal or message which can be used to adjust the pressure targets based on the load of the vehicle.

Air Lines

The Central Tire Inflation System uses a dedicated pneumatic system plumbed from the vehicles' exiting supply tank. Air lines between the Pneumatic Control Unit and the Quick Release Valves (QRV) are called "Upper Control Lines." Air lines between the QRVs and the Wheel Valves are called "Lower Control Lines."

Electronic Control Unit (ECU)

The Electronic Control Unit (ECU) is the control center for the entire Central Tire Inflation System. The ECU receives commands from the driver through push buttons or smart dash. The ECU transmits and monitors appropriate signals throughout the system and can indicate service codes using the terrain LED's (On, Off, Flashing, or DDM "- -").

Pneumatic Control Unit (PCU)

The Pneumatic Control Unit (PCU) is a solenoid controlled manifold that controls the air system. The PCU contains a pressure transducer which measures system pressures.

Speed Sensor or Speed Input

Speed is read from the vehicle data link or a separate speed sensor. This speed signal is important for safety functions.

Supply Pressure Switch (PS)

The Pressure Switch (PS): Is an air brake priority switch. It prevents the Central Tire Inflation System from using air from the supply tank until the brake system is fully charged or when the pressure falls below safe levels.

Supply Pressure Transducer (SXDCR)

The (SXDCR) monitors the supply pressure and prevents the Central Tire Inflation System from using air from the supply tank until the brake system is fully charged or when the pressure falls below safe levels. The SXDCR also ensures that enough pressure exists for the system to operate properly.

Wheels and Tires

On wheels that have integrated wheel valves, the ports from the wheels need to be clocked properly with the hub ports. On wheels with tire hoses, the valve stem cores need to be removed or the system will not be able to inflate or deflate.

Note: This manual covers new vehicles as well as older vehicles no longer in government service. Some diagnostic procedures may work on some vehicles and not on others. Some vehicles may have tire pressure changes that were not approved by Dana and may be resulting in CTI system performance issues. Contact a Dana service specialist to answer any questions you may have.

General Information

General Troubleshooting Tips

When troubleshooting problems it is best to have a laptop computer with the Dana Diagnostic Tool (DDT) installed (see “Diagnostics” on page 13). This will allow you to read service codes and manually operate distinct functions. Some older vehicles may not have a diagnostic port and cannot use the DDT tool.

If the vehicle does not have a diagnostic port, follow these suggested tips: Try to plumb shop air to the vehicle service port or directly to the wet-tank (this is the first tank after the air dryer). This can allow operation of the CTI system without running the engine and will help with listening for air leaks and system operations. In most cases it will take > 115psi shop air pressure to activate the system (close pressure switch).

If the shop air pressure is too low, to activate the system, the pressure switch connector can be removed and the 2 pins in the harness can be shorted together. If the system has a 2 channel PCU and the pressure switch is closed, the supply pressure may still need to be at least >10psi over the selected pressure setting to get the system to function properly. Pay close attention to the terrain LED's to determine the type of service code set (see Pages 9-10).

 **WARNING:** Running the vehicles engine with shop air connected and flowing may back feed the shop air system from the vehicles air system causing damage to the shop air system.

 **WARNING:** Inflating using the DDT in “Test” mode “Inflate” allows the operator to over-inflate the tires.

If shop air pressure meets the above mentioned requirements and the ignition is on or the engine running, make sure the CTIS is functioning by checking the following:

The Terrain, Load, and RF Lights Are Off

1. Vehicle in Black Out mode (DDM = Blank)
2. ECU connector unplugged, battery switch is off, power/ground disconnected, blown fuse

The Terrain, Load, and RF Lights Are Off or DDM = “- -“

1. PCU disconnected or solenoid fault (Selecting a terrain or illuminated back lights may indicate a functioning ECU)
2. ECU connector unplugged (DDM = “- -“)

The ECU powers up in a 5 light flashing fault

The PCU transducer or solenoid may have a problem or be disconnected.

The ECU comes up with one terrain light flashing then faults out (multiple flashing lights)

1. This indicates the tire pressures were checked and something is wrong.
2. Common issues are line and seal leaks (see fault code sections).

If a single terrain light continues to flash and nothing else happens

1. The pressure switch may not be closing. Check the supply air pressure.
2. The vehicle may have an arctic or disable switch that is open.
3. The vehicle compressor governor may be set too low.

In some cases you may notice issues before a fault is logged

1. The system may be in the process of attempting to correct a problem.
2. The problem may be required to reoccur several times.
3. Some problems can occur that will not be detectable by the system.

Additional Tips:

- Try to begin any troubleshooting procedures with all the tire pressures balanced at least + - 5psi.
- Inflations will be extremely slow if the engine RPM is at idle or low.
- If the system is functioning but cannot inflate or deflate recently serviced tires, the Schrader inserts may have been left in place and need to be removed or the wheels internal air ports are not clogged properly.

General Information

Basic Operation and Causes for Issues

This manual covers two basic heavy vehicle CTIS systems circa 1986 to present.

Single Channel (PCU): System measures all the tires on the vehicle at the same time and will average low and high tires together. This system cannot read the supply pressure and relies on the pressure switch (PS) signal to tell it when it is ok to use the vehicles air supply. (ID = 2 air lines connected to PCU) not including the cover vent.

Two Channel (PCU): System measures the tire pressure average of the front axles and the rear axles independently. This system has the ability to measure the supply tank pressure before it begins pressure changes. It can also log faults separately on each channel while allowing the other channel to stay functional. This systems still uses a (PS) or (SXDCR) (see [page 2](#) for description). (ID = 3 air lines connected to PCU) not including the cover vent.

If the System Is Checking The Tire Pressures: The system will first put a short burst of high pressure air into the channel air lines and wait for it to settle into the tires before it begins to inflate or deflate.

The following are things that can cause the system to malfunction after the check:

1. The system is trying to reach the highest pressure but seems to be deflating periodically. This is due to the one or more wheel valves not closing. When wheel valves do not close properly they vent out the QRV just like a deflation, often described as the system cycling.
2. Airline leaks: These may cause the tire pressure readings to read low and can cause a variety of faults depending on how severe the leak is. Some tires can become over inflated at times.
3. Air seal leaks: these are hard to find and usually leak into the axle housing, but can be found by feeling the axle vent tube during an inflation. The axle vents locations will vary on independent suspensions.
4. Inaccurate tire pressure readings are typically caused by airline and seal leaks or dirty wheel valve filters.
5. If valve stem cores are installed they will prevent inflation and deflation.

Note: Air leaks will be more detectable during inflations. If the system is venting at QRVs after an inflation, shut the system off during the venting and measure the tire pressures to locate the suspect wheel valve.

 **WARNING:** Inflating using the DDT in “Test mode”-“Inflate” allows the operator to over-inflate the tires.

Components and Likelihood to Cause a Failure

1. ECU: Almost never the issue (very low)
2. PCU: The pressure transducer would be the likely cause of any PCU issue
3. Wheel Valves: Old valves can be the cause of poor shut off at high tire pressures
4. Air Seals Leaking: Can be common in older vehicles
5. Pressure Switch: These have been known to fail occasionally
6. QRV: These almost never fail, but can sometimes get contaminated but can be cleared
7. Severe Cold Temperature: This can cause leaking air seals and wheel valve to close poorly at high tire pressures (vent wheel valve cover screws at extreme cold only) system off
8. Check old wheel valves for hardened diaphragms or contaminated seats

Some causes in the “Service Code Summaries” are listed for several different fault codes because the logged code can be dependent on several factors such as:

- Did the system inflate or deflate first
- How long did the system operate before the fault was logged
- Were the tires imbalanced when the fault logged
- How severe is an airline or seal leak
- How many axles are on the channel that logged the fault
- Was the ambient temperature extremely cold

The fault code causes are always listed in order of the likelihood of the cause. These same causes may be in different orders for different faults. Some faults may occur on a single axle channel and for the same conditions a different fault may occur on a multi-axle channel. In the interest of simplifying this manual the causes for faults do not take into account how many axles are on a given channel.

Note: For safety reasons, the CTI system is designed to allow heated tires to increase pressure during normal vehicle operation. System before 2016 will not automatically deflate off this pressure increase. A lower pressure mode must be selected, initiating a deflation to compensate for any over pressurization not caused by normal vehicle driving.

Note: The CTI system can increase the tire pressures a slight amount over several hours of operation. This can be excessive if the system is allowed to operate for very long periods of time in a single terrain setting. For safety reasons, the system will not deflate off tire pressure increases; so it is advised to manually check the cold tire pressures periodically and initiate a deflation if necessary.

General Information

Central Tire Inflation System Components

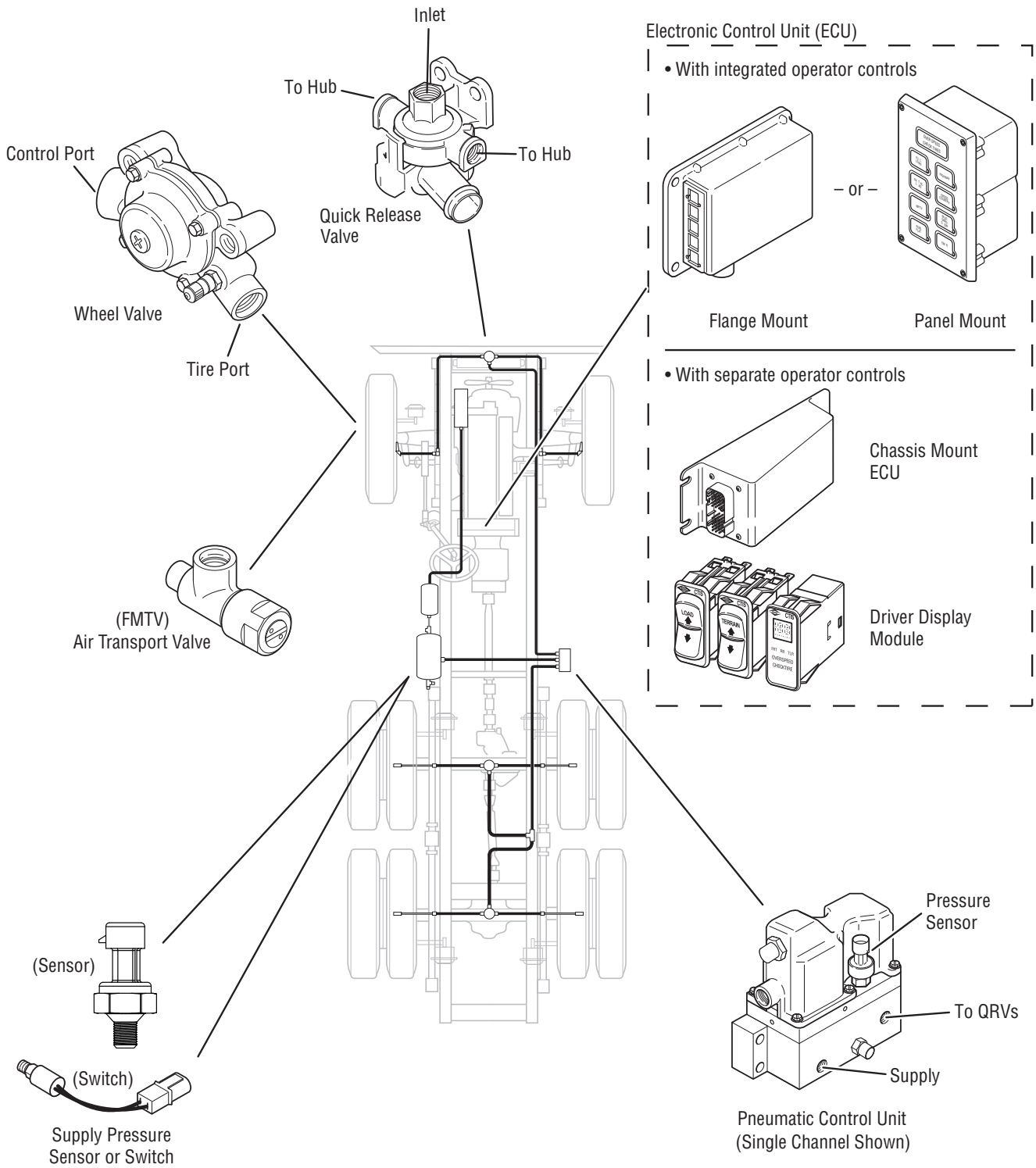

General Information

Simplified System Schematic

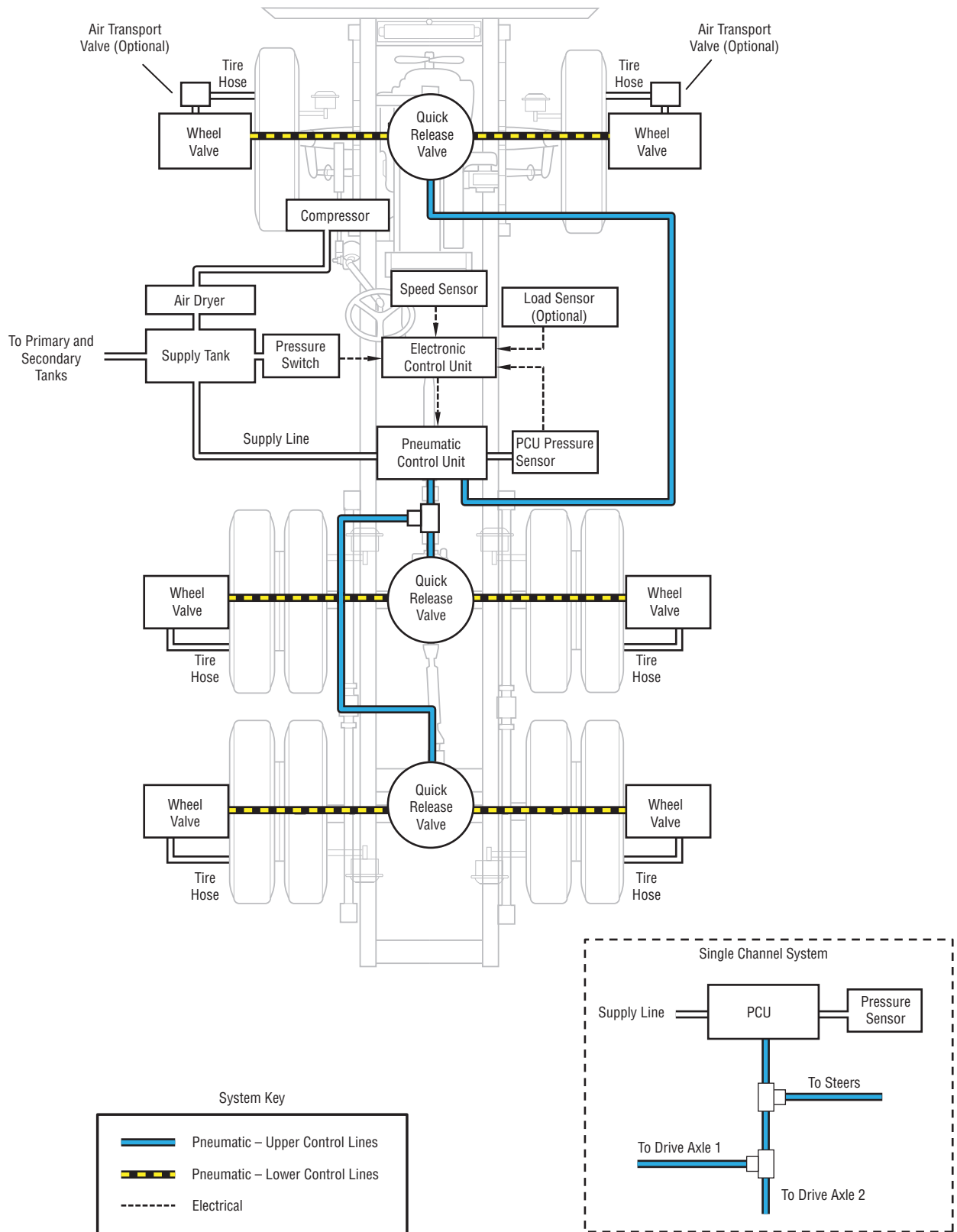

Operator Instructions

Flange or Panel - Operator Controls

The integrated push button/display is the primary interface for display of system information and for push button entry of system instructions. The following sections explain the purpose and operation of the ECU controls and display.

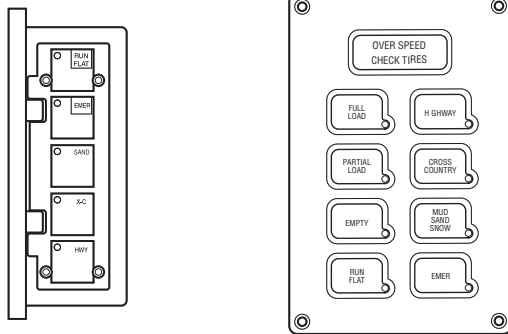

Terrain Selection

These keys select pressures appropriate for different surface conditions. Any mode may be selected at any time, but the proper speed limitation must be adhered to or the selected mode may be automatically changed to a higher pressure. Depressing the button for the current mode will result in a pressure check.

HWY (Highway): For operation on improved paved surfaces

XC (Cross Country): For operation on non-paved secondary roads

SAND (Sand): For operation on trails and other unimproved surfaces

EMER (Emergency): For selection of extremely low tire pressures to help free a stuck vehicle or to traverse a short distance over a terrain known to require very low tire pressures. Since this is an extremely low pressure, a warning indicator may automatically turn on.

⚠ WARNING: The “EMER” selection is for extreme conditions and may be automatically restricted to 1 – 10 mph depending on the vehicle configuration.

Load Selection (Optional)

This feature allows selection of pressures appropriate for different vehicle load conditions (full, partial, empty or other). Switching the load setting will result in a pressure check and subsequent changing of the pressures as determined by the system.

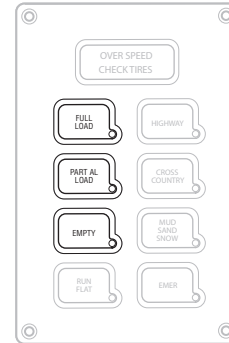

Mode Annunciator Lights

The associated annunciator lights indicate the selected mode and signal one of two states:

If the light is flashing:

The system is in the process of checking or changing pressures to attain the pressure(s) associated with that flashing mode light.

Some clicking may be heard from the PCU as the system cycles to achieve the new pressure(s). A deflate may be periodically interrupted as the system checks tire pressures to determine how much further deflation is necessary.

Note: Adequate supply system pressure is required to begin or continue any pressure changing sequence.

If the light is on steady for more than 30 seconds:

The selected pressure has been achieved, the tires have been isolated, and the system is depressurized. The system will cycle periodically to assure that tire pressures are maintained.

Operator Instructions

Run Flat Key and Annunciator Light

This key instructs the system to check tire pressures at more frequent intervals. This key also allows the operator to override the “4 flashing lights” (tire leak imbalance) codes and reattempt 2 lights and some 5 lights codes. (See Warning Signals in next section). While the system is in RUN FLAT mode, the RUN FLAT light will flash on and off. The “RUN FLAT” feature will automatically deselect after 10 minutes or may be shut off by pressing the button a second time.

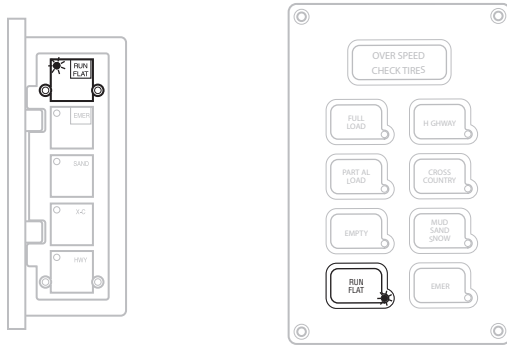

⚠ CAUTION: Selecting “RUN FLAT” to enable the system to inflate a significantly low tire may cause the other tires on that channel to temporarily lose pressure. This condition will be corrected once the low tire is inflated to the pressure of the other tires.

Operator Instructions

Warning Signals for Flange and Panel ECU's

Several warning signals report operating problems. The Central Tire Inflation System uses general sequences displayed on the electronic control unit lights and an instrument panel-mounted warning lamp to identify the type and area of fault.

Single Terrain Light

- Flashing - System is checking the tire pressures or working to achieve a new pressure associated with that mode light
- Solid - Pressure is achieved, system is not active, and wheel valves are closed. When new pressures are reached, 30 seconds later a pressure check will be performed to ensure wheel valve closure
- If solid for 30 seconds then Flashes repeatedly, the 30 second confirmation check is failing

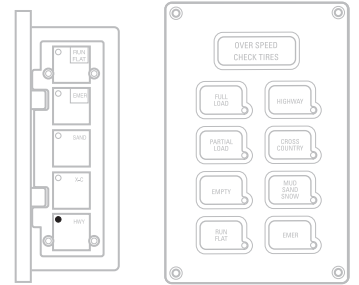

2 Terrain Lights on Solid

System has shut off, closing wheel valves with tire pressure between two mode settings.

- Inflating or deflating tires is taking too long
- CTIS is still operational
- Select any mode button to re-attempt pressure change
- On 2-channel systems, normal operation continues on unaffected channel
- Frequent occurrences may indicate need for service

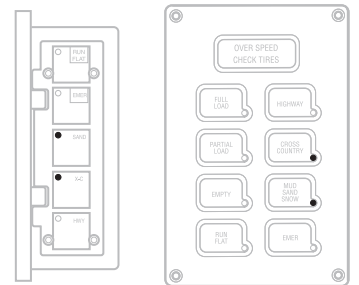

4 Terrain Lights Flashing or CHECK TIRES Flashing

Indicates low pressure in one or more tires. Stop vehicle and identify damage.

- System shuts off, closing wheel valves, and waits for operator instruction
- Tire damage is possible
- CTIS should not be operated if major tire damage is found. Repair tire before continuing to operate vehicle
- On 2-channel systems, normal operation will continue on the unaffected channel
- If tire damage is minimal, operate CTIS by selecting RUN FLAT

Note: Repeated use of RUN FLAT to override mode light warnings may result in tires inflating higher than set point.

Note: Excessive air seal leakage on cold weather startup may result in "4-5 Mode Lights" warning. If no tire damage exists, this condition will self-correct as seals warm up with use.

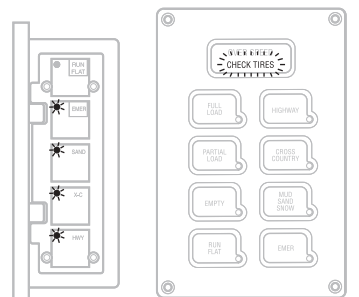

5 Lights Flashing

System shuts off at least one channel due to fault detection on a CTIS component.

- System closes wheel valves
- System may periodically cycle PCU to determine if fault still exists
- On 2-channel systems, operation may be allowed on the unaffected channel
- Get service at next opportunity
- No ability to override system

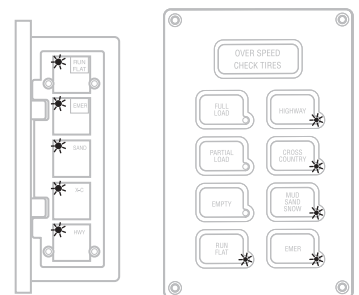

Operator Instructions

RUN FLAT Flashing (with a Terrain Light)

RUN FLAT is selected, and tire pressures are checked at more frequent intervals.

- If RUN FLAT is pushed to clear a “4 Mode Lights” flashing display, imbalance and confirmation fault detection is overridden for the duration of RUN FLAT
- Turn off by depressing RUN FLAT again or it will “time-out” after 10 minutes



WARNING: RUN FLAT should not be used to inflate tires with substantial damage/defects. Use of RUN FLAT can result in other tires on the channel losing pressure.

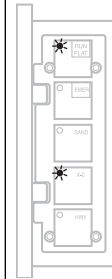

No Terrain Lights

CTIS senses either a low system voltage or an electrical fault with a Pneumatic Control Unit solenoid.

- System shuts off, closing wheel valves
- Vehicle power is inadequate

Flashing Warning Lamp and/or Buzzer or OVER SPEED Flashing

- Vehicle speed is too fast for the selected mode
- Reduce speed or select higher pressure by pressing appropriate key
- Continued operation in this mode will result in automatic selection of more appropriate pressure settings unless already in “Highway”
- Warning lamp may automatically flash while system is in EMERGENCY mode

Lamp on Instrument Panel

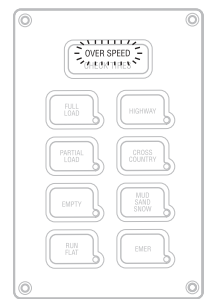

Solid Warning Lamp or Solid OVER SPEED

The ECU has had (50) ignition cycles with no speed signals present, or the CAN speed message is not present

- If no problem exists with speed circuit wiring or sensor, lamp will go off when vehicle is moved

Lamp on Instrument Panel

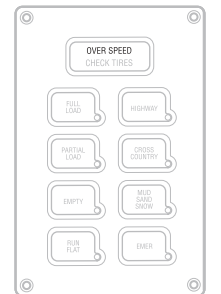

Lights Sequentially Flashing (one after another)

A configuration error has occurred, or the new ECU has not been properly configured (possible download file needed). See [“Sequentially Flashing Lights or “dL” displayed on DDM” on page 51](#) and [“Configuration Options” on page 70](#).

- System reloads default configuration values
- Any past changes of target pressure, etc. should be updated

Operator Instructions

Driver Display Module—Operator Controls

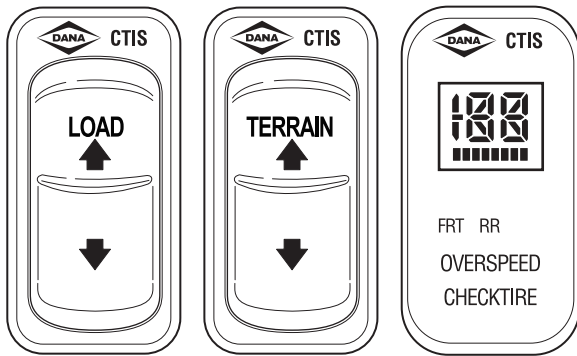

Load Selection

Vehicle load selection is represented by a horizontal bar graph under the mode display. Depress the load rocker switch to change the selection, up for increasing load and down for decreasing load.

CAUTION: Operating a loaded vehicle at unloaded tire pressures may result in tire overheating and reduced tire life or blowout.

Terrain Selection

The terrain selection is changed by depressing the terrain rocker switch, up to increase pressures and down to decrease pressures. Any switch operation will command a pressure check, and may result in a pressure change.

Tire pressures for the following terrains can be programmed and may be selected by the operator:

- **(HY) Highway:** For travel on paved surfaces at higher speeds
- **(CC) Cross Country:** For reduced speed operation on secondary roads
- **(SS) Mud Sand Snow:** For reduced speed operation on unpaved surfaces
- **(E) Emergency:** For selection of extremely low tire pressures to help free a stuck vehicle
- **“Run Flat”:** For manual selection of (RF), the system will need to receive a bus message from a smart dash interface

CAUTION: The Emergency selection is for extreme conditions only and should not be used for normal driving.

Display

The Driver Display Module (DDM) uses a multi-function display to indicate the current selections. The display will show HY for highway pressures, CC for cross-country pressures, SS for mud-sand-snow pressures, and E for emergency pressures.

Note: The system is designed to allow tire pressure increase due to heat buildup during vehicle use. It will not automatically deflate these pressure buildups.

Channel Indicators

The DDM indicates FRT or RR, respectively, for front or rear axle groups. A flashing indicator identifies a group which is changing or checking pressures. A solid indicator identifies a group that has achieved target pressure.

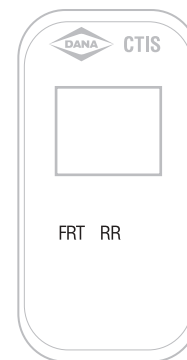

Service Code Indication

The DDM will not display service codes directly but will display two dashes if service is required (Accessing the service codes requires a diagnostic tool). A solid “over speed” indicator identifies a loss of expected vehicle speed input.

The two dashes can also mean “Loss of power” to the ECU or “Loss of communication,” most likely caused by a wiring issues.

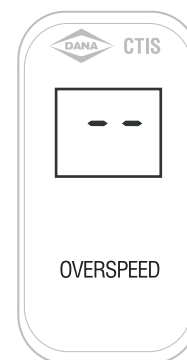

Operator Instructions

Driver Display Module (DDM) - Warnings

Signals

CTIS includes two distinct warnings to report possible tire problems and inappropriate vehicle operation. You must take immediate action to either reduce vehicle speed or check tire condition whenever these warnings are displayed.

Over Speed Flashing

This signal reports that the vehicle speed is too fast for the pressure selected. You must either reduce speed or select a higher pressure by the appropriate switch selection. Continued operation in this mode may result in the system automatically selecting a more appropriate pressure setting unless already in "Highway" mode.

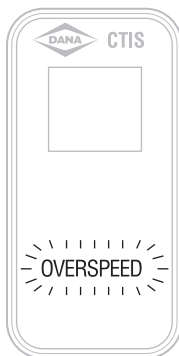

Check Tire Flashing

This signal reports that one or more tires may be at a significantly lower pressure than the others and could indicate that a tire is not holding pressure. Blinking channel indicators (FRT or RR) indicate the fault location. Stop the vehicle immediately in a safe place and identify the extent of tire damage.

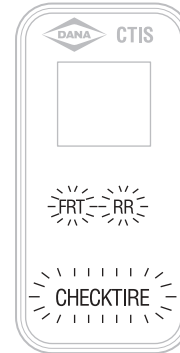

⚠ IMPORTANT: Tires can still go flat! Although the Central Tire Inflation System is designed to identify under-inflated tires and fill these tires to the desired operating pressure, you can still expect that tires may occasionally be punctured or otherwise damaged during normal use and no longer retain air reliably. A daily walk-around inspection of the vehicle at the start of the day, including a manual check of the tires, is still an important responsibility of the vehicle operator. Tire damage is more apparent after the vehicle has been idle overnight and may be more difficult to detect visually once the vehicle is in operation. Although observation of excessive inflations by monitoring the driver interface can help identify a tire problem, you should have damaged tires repaired immediately before any further vehicle operation.

Diagnostics

Diagnostics

This section covers the equipment and procedures used to find and correct CTIS problems.

Test Equipment

CTIS troubleshooting can be performed at three levels:

1. PC diagnostics
2. Handheld tester
3. ECU warning signals (flashing light combinations)

Regardless of the testing equipment used, the troubleshooting procedures will be based upon the diagnostic service codes. Diagnostic tools offer the advantages of computer-aided testing without interpreting service codes.

CTIS Diagnostics

The onboard system diagnostics are an important feature of Dana's CTIS. This section describes the use of service codes to identify CTIS operating problems.

The CTIS uses a code to identify service issues. The codes can be extracted from the ECU memory using a diagnostic service tool equipped with the appropriate software. Refer to the Service Codes Summary for more detailed information on service codes.

Service Codes

Codes are described in the Service Codes Summary section. Some service codes identify the component that is associated with the problem. A list of possible causes is shown in order of most likely occurrence.

In addition, the system stores service codes in the memory of the ECU. These historical codes can only be accessed by a diagnostic tool. Historical codes are automatically cleared after 50 ECU resets with no active faults.

PC Diagnostic Test Modes

Diagnostic tools allow the system to be placed in several diagnostic modes:

Info: Display ECU information and configuration

Codes: Active and historic codes are listed as reported by the ECU

Monitor (Normal): CTIS operates normally, while status of system components is observed

Test: The following operations can be performed on each channel (axle group):

- **Check & Hold:** System checks and displays the pressures, then holds pressure in air lines (quick test of control line and seal integrity)
- **Deflate:** System "manually" deflates (test the deflation signal)
- **Inflate:** System "manually" inflates (test for large leaks)
- **Hold:** Pressure is held in control lines (test for small leaks)

Setup: Allows the technician to modify parameters such as tire target pressures, over-speeds, etc.

Diagnostics

PC Diagnostics

CAUTION: A battery charger without batteries connected to the vehicle is not an adequate power source.

Visit www.dana.com for a free download of the Dana Diagnostic Tool (DDT):

- PC diagnostics are easy to use and provide the quickest diagnostic capabilities.
- Retrieve historical data, faults, and tire pressures.
- Pressurize system to detect leaks.
- Access troubleshooting flowcharts and service procedures.

To use this program, an RP1210A compatible interface box and cables are needed to connect the PC to the vehicle.

For these types of interface boxes to work with the Dana Diagnostic Tool program, you must install a “RP1210 driver” program provided by the manufacturer of the interface box. If you do not have this program, it can normally be obtained from the manufacturer’s web site. Please contact the manufacturer of your interface box if you have any questions regarding this process.

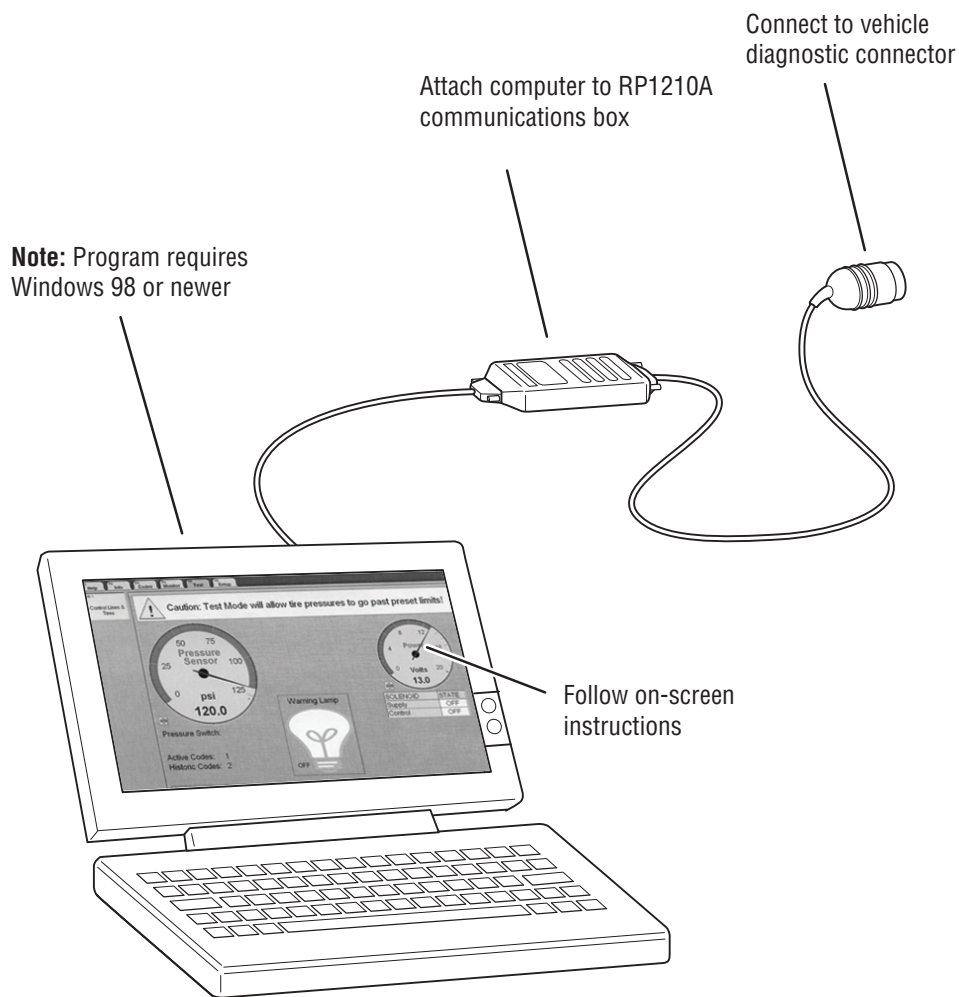

Diagnostics

Handheld Tester

For legacy applications the ProLink handheld tester may be used to read and clear service codes and to obtain a short description of failures. The tester can initiate test sequences for controller outputs and can also read system parameters when equipped with the Eaton Roadranger program card.

Note: The ProLink tester is not readily available. Dana recommends using the PC based DDT tool.

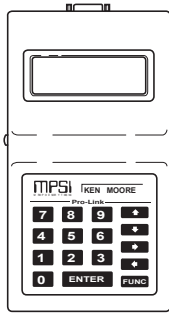

Pressure Gauge

For measuring tire pressures, a quality digital pressure gauge with a minimum of 1.0 psi resolution or better is recommended.

Note: Stick-type pressure gauges can be highly inaccurate.

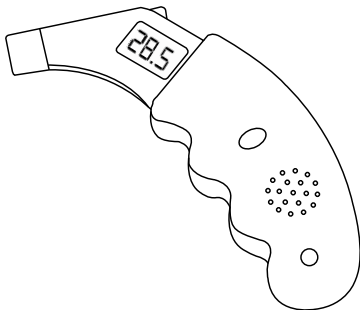

Multimeter

Based upon system schematics and aided by component specific service codes, a multimeter can be used to check sensor and solenoid resistances and to find wiring harness faults. The multimeter can be used to check the Tire Pressure Control System wiring and components for:

- Continuity
- Ground
- Broken wires
- Open circuits
- Shorted circuits
- Incorrect battery voltage

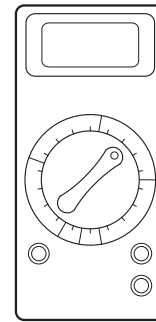

Diagnosics

Service Codes Summary

The following chart provides a brief overview of the Central Tire Inflation System (CTIS) service codes and the effect on the system.

Note: Any reference to a “channel” on a single-channel system refers to all control lines and wheel ends.

5 FLASHING LIGHTS OR DDM – DASHES “--”

| | CODE NO. | CAUSES (NUMBERED IN ORDER OF LIKELY OCCURRENCE) |
|---------------------------------------|---------------------------------------------------|--------------------------------------------------------------------------------------------------------------------------------------------------------------------------------------------------------------------------------------------------------------------------------------------------------------------------------------------------------------------------------------------------------------------------------------------------------------------------------------------------------------------|
| Low Pressure Reading (Pages 23-24) | 26 (Single ch) 26 (2ch Front) 27 (2ch Rear) | CHANNEL PRESSURE LOW (Channel only checks pressures): Pressure check of given channel returns low reading (< 5 psig) indicating an extreme loss of pressure. Repair and request pressure check to clear (press any mode button or run flat). 1) Open or broken air line between PCU and wheel valve 2) Kinked or plugged line between supply tank and PCU (Single Ch) 3) Pressure switch failure (shorted closed) (Single Ch) 4) PCU Supply or Control failure (Single Ch) |
| Pressure Switch (Pages 25-26) | 31 (2 ch only) | PRESSURE SWITCH FAILED CLOSED (System waits to check pressures): Pressure switch is read as closed, but pressure check of supply tank indicates insufficient air pressure to continue. 1) Repair and cycle ignition to clear the fault 2) Signal wire from pressure switch shorted to ground 3) Faulty pressure switch (failed closed) 4) Faulty PCU, leaks air during supply check (not very likely) |
| Low Air Supply (Pages 27-28) | 32 | PRESSURE SWITCH REMAINS OPEN (System non-operative until switch closes): For 4 minutes at vehicle speed > 20 mph pressure switch failed Open. 1) Repair and allow pressure switch to close to clear 2) Compressor governor cutout set too low 3) Pressure switch unplugged, or open wire 4) Faulty pressure switch failed open 5) Broken, kinked or plugged line from compressor to supply tank |
| PCU Sensor (Pages 29-30) | 34 (Null) | NO PCU SENSOR READING (System non-operative): No sensor voltage to ECU. Clears 5 seconds following a valid reading. 1) Sensor is electrically disconnected 2) Pressure signal wire (XDCR SIGNAL) shorted to ground or open 3) PCU sensor VREF wire is shorted to ground or open 4) Faulty sensor |
| Atmospheric (Pages 31-32) | 35 | ATMOSPHERIC READING OUT OF RANGE (System waits to check pressures): Atmospheric pressure check indicates vented PCU pressure is outside of valid atmospheric range (5-20 psia). 1) Repair and request pressure check to clear (press any mode button or run flat) 2) Poor ground connection to PCU sensor 3) Faulty PCU sensor (e.g., frozen water contamination) 4) Faulty PCU or blocked PCU exhaust vent |

Diagnostics

Service Codes Summary (continued)

5 FLASHING LIGHTS OR DDM – DASHES “--”

| | CODE NO. | CAUSES (NUMBERED IN ORDER OF LIKELY OCCURRENCE) |
|--------------------------------|------------------------------------------------------------------------|----------------------------------------------------------------------------------------------------------------------------------------------------------------------------------------------------------------------------------------------------------------------------------------------------------------------------------------------------------------------------------------------------------------------------------------------------------------------------------------------------------------------------------------------------------------------------------|
| Deflate Trend (Pages 33-34) | 14 | <p>FAILURE TO DEFLATE PROPERLY (System disables deflation): System cannot lower all tires on an effected channel even a small amount of the intended change or the system pressure increased by >10 psi during deflation.</p> <p>Repair and cycle ignition to clear.</p> <ol style="list-style-type: none"> 1) Restricted wheel valve tire ports; plugged filters, schraders installed, plugged hoses 2) Plugged or restricted QRV vents 3) Wheel internal ports clocked wrong (integrated WVs only) 4) Faulty PCU (not likely) |
| Inflate Trend (Pages 35-36) | 36 (Single ch) 36 (2ch Front) 37 (2ch Rear) | <p>INFLATE PRESSURE LOSS (System disables given channel): Given channel loses a % of the desired target while inflating.</p> <p>Repair and cycle ignition to clear.</p> <ol style="list-style-type: none"> 1) Damaged or leaking tire 2) Leaking lines or seals 3) Faulty PCU (not likely) |

Diagnostics

Service Codes Summary (continued)

4 FLASHING LIGHTS OR CHECK TIRES FLASHING

| | CODE NO. | CAUSES (NUMBERED IN ORDER OF LIKELY OCCURRENCE) |
|----------------------------------------|------------------------------------------------------------------------|------------------------------------------------------------------------------------------------------------------------------------------------------------------------------------------------------------------------------------------------------------------------------------------------------------------------------------------------------------------------------------------------------------------------------------------------------------------------------------------------------------------------|
| Tire Leak (Imbalance) (Pages 37-38) | 44 (Single ch) 44 (2ch Front) 45 (2ch Rear) | <p>TIRES IMBALANCED: The system will attempt to correct any imbalance. This fault may be logged and the channel disabled if the selected tire pressure setting has been reached and the “Imbalance” is still detected by the system.</p> <p>Pressing “RUN FLAT” will override this fault.</p> <ol style="list-style-type: none"> 1) Significant tire pressure loss (possibly overnight) 2) Significant tire hose leak 3) Kinked or restricted upper control line |
| Tire Leak (Confirm) (Pages 39-40) | 41 (Single ch) 41 (2ch Front) 42 (2ch Rear) | <p>CONFIRMATION FAILURE (System disables given channel): Given channel fails to confirm 10 times in a row.</p> <p>RUN FLAT will override this fault.</p> <ol style="list-style-type: none"> 1) Damaged or leaking tire 2) Faulty wheel valve (leaking back through QRV) 3) Extremely cold ambient temperatures |

2 TERRAIN LIGHTS ON SOLID OR DDM – DASHES “--”

| | CODE NO. | CAUSES (NUMBERED IN ORDER OF LIKELY OCCURRENCE) |
|--------------------------------|------------------------------------------------------------------------|-------------------------------------------------------------------------------------------------------------------------------------------------------------------------------------------------------------------------------------------------------------------------------------------------------------------------------------------------------------------------------------------------------------------------------------------------------------------------------------------------------|
| Between Modes (Pages 41-42) | 23 (Single ch) 23 (2ch Front) 24 (2ch Rear) | <p>SLOW INFLATE (Channel only checks pressures): Given channel takes too long in active inflate to achieve desired mode (> 40 minutes) with the pressure switch closed.</p> <p>Repair and cycle ignition to clear fault.</p> <ol style="list-style-type: none"> 1) Insufficient air supply (high pressure, but low flow) 2) Contaminated wheel valve filters 3) Leaking lines or seals 4) Inflating at the engine idle speed |
| | | <p>SLOW DEFLATE (Channel only checks pressures): Given channel takes too long in active deflate (> 20 minutes) to achieve requested mode.</p> <p>Repair and cycle ignition to clear fault.</p> <ol style="list-style-type: none"> 1) Contaminated wheel valve filters 2) Restricted tire valve stem 3) Restricted QRV exhaust |

Diagnostics

Service Codes Summary (continued)

2 TERRAIN LIGHTS ON SOLID OR DDM – DASHES “--”

| | CODE NO. | CAUSES (NUMBERED IN ORDER OF LIKELY OCCURRENCE) |
|---------------------------------|-------------------------------------------------------------------------------------------------|---------------------------------------------------------------------------------------------------------------------------------------------------------------------------------------------------------------------------------------------------------------------------------------------------------------------------------------------------------------------------------------------------------------------------------|
| Deflate Signal (Pages 43-44) | 16 (Single ch) 16 (2ch F&R) 11 (Front Only) 12 (Rear Only) | INCORRECT DEFLATE PRESSURE: Deflate signal reads outside of configured range for 30 seconds. If occurs during multi-channel deflate, system will reattempt deflates on individual channels. Repair and cycle ignition to clear the fault. 1) Faulty PCU relief valve 2) Leaking (upper) control lines 3) PCU internal leaks 4) Poor ground connection to PCU sensor or faulty sensor |

NO TERRAIN LIGHTS OR DDM – DASHES “--”

| | CODE NO. | CAUSES (NUMBERED IN ORDER OF LIKELY OCCURRENCE) |
|-------------------------------|-------------------------------------|-------------------------------------------------------------------------------------------------------------------------------------------------------------------------------------------------------------------------------------------------------------------------------------------------|
| PCU Solenoid (Pages 45-46) | 51, 52, 54, 55, 56 | SOLENOID ELECTRICAL FAILURE (System non-operative): The ECU may appear to be blanked out Repair & cycle ignition to clear the fault. 1) Solenoid or harness wire broken or disconnected 2) Solenoid or harness wire is shorted to ground 3) Faulty solenoid |

NO TERRAIN LIGHTS OR DDM – BLANK DISPLAY

| | CODE NO. | CAUSES (NUMBERED IN ORDER OF LIKELY OCCURRENCE) |
|------------------------|-----------|--------------------------------------------------------------------------------------------------------------------------------------------------------------------------------------------------------------------------------------------------------------------------------------------------------------------------------|
| Power (Pages 47-48) | 17 | POWER (System non-operative): For 24v system (18 - 33) volts. For 12v system (9 - 16) volts. When proper voltage is restored the ECU will recover automatically. 1) Low battery voltage 2) Poor ground connection to ECU 3) Poor power connection to ECU 4) High battery voltage |

DDM – DASHES “--”

| | CODE NO. | CAUSES (NUMBERED IN ORDER OF LIKELY OCCURRENCE) |
|----------------------------------------------------|-----------|-------------------------------------------------------------------------------------------------------------------------------------------------------------------------------------------|
| Display Control Communications (Pages 49-50) | 75 | NO COMMUNICATION TO DDM: ECU not receiving data from DDM user interface. Repair to clear. 1) No data link connection to DDM (damaged harness wiring) 2) Faulty DDM |

Diagnostics

Service Codes Summary (continued)

LIGHTS SEQUENTIALLY FLASHING

OR "DL" ON DDM

| | CODE NO. | CAUSES (NUMBERED IN ORDER OF LIKELY OCCURRENCE) |
|-----------------------------------------------------------------------------|----------|-----------------------------------------------------------------------------------------------------------------------------------------------------------------------------------------------------------------------------------------------------------------------------------------------------------------------------------------------------------------------------------------------------------------------------------------------------------------------------------------------------------------------------------------------|
| Expecting parameters to be Down-Loaded or Configuration Reset (Pages 51-52) | N/A | <p>CONFIGURATION RESET (System is "Limp-Home"): System has reloaded the default parameter setting the ECU to essentially New condition. This will eliminate any previous change to the software including downloads, target pressures, etc.</p> <p>The default software may cause the system to function erratically and log faults.</p> <p>1) Configuration wire broken or connector missing</p> <p>2) If Repeatedly Occurring: Intermittent config wire contact or faulty ECU</p> <p>Note: Faulty ECU is very rare</p> |

SOLID WARNING LAMP OR SOLID "OVER SPEED"

| | CODE NO. | CAUSES (NUMBERED IN ORDER OF LIKELY OCCURRENCE) |
|----------------------------|----------|-------------------------------------------------------------------------------------------------------------------------------------------------------------------------------------------------------------------------------------------------------------------------------------------------------------------------------------------------------------------------------------------------------------------------------------------------------------------------------------------------------------------------------------------------------|
| Speed Signal (Pages 53-54) | 18 | <p>NO SPEED SIGNAL (System operation is normal): ECU has been reset/power cycled 25-50 times without any speed input to ECU, after which the Fault will be set immediately on each power up.</p> <p>Driving the vehicle with a good speed signal will clear the fault.</p> <p>1) Sensor is electrically disconnected</p> <p>2) Either speed sense wire is open or shorted to ground</p> <p>3) Incorrect gap on pole sensor</p> <p>4) Faulty speed sensor</p> <p>5) Both speed sense wires are shorted together</p> |
| | 76, 77 | Expected data link message not received |

NO INDICATION ON ECU DDM DISPLAYS "--"

| | CODE NO. | CAUSES (NUMBERED IN ORDER OF LIKELY OCCURRENCE) |
|----------------------|----------|-----------------------------------------------------------------|
| No Data Link Message | 73 | J1939 Load information unavailable, check ECU CAN connection |
| No Data Link Message | 74 | J1939 Terrain information unavailable, check ECU CAN connection |
| No Data Link Message | 78 | J1939 Gear information unavailable, check ECU CAN connection |

NO INDICATION OR DDM - DASHES "- -"

| | CODE NO. | CAUSES (NUMBERED IN ORDER OF LIKELY OCCURRENCE) |
|---------------------------------|--------------------|------------------------------------------------------------------------------------------------------------------------------------------------------------------------------------------------------------------------------------------|
| Miscellaneous Output (Optional) | 53, 57, 58, 67, 68 | <p>SPARE OUTPUT OR COMPONENT FAILURE:</p> <p>1) Harness wire is broken or disconnected</p> <p>2) Harness wire is shorted to ground</p> <p>3) Faulty component</p> <p>4) Harness wire is shorted to power</p> |

Diagnostics

Service Codes Summary (continued)

5 FLASHING

LIGHTS OR

DDM – DASHES “- -”

CODE NO.

CAUSES (NUMBERED IN ORDER OF LIKELY OCCURRENCE)

| | | |
|-----------------------------------------------------|-----------|---------------------------------------------------------------------------------------------------------------------------------------------------------------------------------------------------------|
| Supply Tank Sensor - Null-Pressure (Pages 55-56) | 47 | NO SUPPLY TANK PRESSURE READING: (Cleared 5 seconds after valid reading) 1) Sensor wire is broken or disconnected 2) Signal wire is shorted to ground 3) Faulty sensor |
|-----------------------------------------------------|-----------|---------------------------------------------------------------------------------------------------------------------------------------------------------------------------------------------------------|

5 FLASHING

LIGHTS OR

DDM – DASHES “- -”

CODE NO.

CAUSES (NUMBERED IN ORDER OF LIKELY OCCURRENCE)

| | | |
|-----------------------------------------------|-----------|------------------------------------------------------------------------------------------------------------------------------------------------------------------------------------------------------------------------------------------------------------------------------------------------------------------------------|
| Supply Tank Sensor - Erratic (Pages 55-56) | 48 | PCU Pressure Reading And Supply Tank Reading Do Not Match: (Cleared 5 seconds after valid reading) 1) Sensor wire is broken or disconnected 2) Faulty sensor 3) PCU sensor issue (See faults 34, 47) 4) Plumbing restriction supply line 5) Sensor wire shorted to Vref |
|-----------------------------------------------|-----------|------------------------------------------------------------------------------------------------------------------------------------------------------------------------------------------------------------------------------------------------------------------------------------------------------------------------------|

NO INDICATION

CODE NO.

CAUSES (NUMBERED IN ORDER OF LIKELY OCCURRENCE)

| | | |
|------------------------------------------------|------------------------------------------------------------------------|---------------------------------------------------------------------------------------------------------------------------------------------------------------------------------------------------------------|
| Wheel Valve Sluggish Shut Off (Pages 59-61) | 61 (Single ch) 61 (2ch Front) 62 (2ch Rear) | Minor Loss of Pressure During Shut Off: 1) Old or contaminated wheel valves 2) Extremely cold ambient temperature 3) Control hose restriction 4) QRV vent restriction |
|------------------------------------------------|------------------------------------------------------------------------|---------------------------------------------------------------------------------------------------------------------------------------------------------------------------------------------------------------|

NO INDICATION

CODE NO.







CAUSES (NUMBERED IN ORDER OF LIKELY OCCURRENCE)

| | | |
|---------------------------------------|------------------------------------------------------------------------|-------------------------------------------------------------------------------------------------------------------------------------------------------------------------------------------------------------------------------------------------------------------------------|
| Wheel Valve Shut Off (Pages 60-61) | 64 (Single ch) 64 (2ch Front) 65 (2ch Rear) | Sustained Loss of Pressure During Shut Off: 1) Loss of air due to a damaged tire or tire hose 2) Extremely cold ambient temperature 3) Old or contaminated wheel valves 4) Control hose restriction 5) QRV vent restriction |
|---------------------------------------|------------------------------------------------------------------------|-------------------------------------------------------------------------------------------------------------------------------------------------------------------------------------------------------------------------------------------------------------------------------|

Diagnostics

Troubleshooting Tips

This checklist outlines some general hints and guidelines that may be helpful in tracking down and correcting operating problems. Also see [“General Troubleshooting Tips” on page 3](#).

-  **The System can only display one active code**
Only the most recent service code displays on the ECU lights. In troubleshooting, be alert for related codes. Use of a diagnostic tool offers the advantage of spotting multiple active codes as well as retrieving historical codes.
-  **A cleared code alone does not indicate a corrected problem**
A code is set by a specific fault condition and may be cleared by switching the ignition off, and then on. It's possible to clear a code (i.e., clear the flashing lights) only to have it display again when the fault condition reoccurs. To ensure that a problem is fixed, you must run the system through the same operating modes that caused the problem and verify that the service code does not reappear.
-  **Electrical faults are often connection problems**
The most likely cause of electrical faults may be damaged wires or connections. As a first step in troubleshooting electrical codes, switch off vehicle ignition, then disconnect applicable connectors and inspect for damage. Switching off the ignition is required before disconnecting the harness at the Electronic Control Unit, but is also a recommended practice before all other electrical system disconnections. Clean or repair all bad connections before proceeding.
-  **Disconnect the Electronic Control Unit connector with ignition off**
To avoid setting electrical fault codes, make sure that the ignition is off before unplugging the wire harness connection at the Electronic Control Unit module. Reconnect the connector before switching on the ignition.
-  **System is not continually pressurized**
When troubleshooting pneumatic faults, keep in mind that the air system is only pressurized as needed (for example, in the inflate mode). This means that such procedures as checking for leaks require the system to be in an active pressurized state. This can be accomplished most easily by using a diagnostic tool.
-  **Basic vehicle air and power systems are not covered in this guide**
The Central Tire Inflation System requires air pressure and electrical power supply from the base vehicle systems. Diagnosis and service of these systems is outside the scope of this manual.
-  **2-Channel (front/rear) systems may respond differently than single-channel systems**
If a fault can be isolated to a specific channel, a 2-channel system may allow continued operation on the unaffected channel. When troubleshooting, use a diagnostic tool to determine which channel has the fault.

Note: For more troubleshooting tips, also see [“General Troubleshooting Tips” on page 3](#). Most of the following troubleshooting flow charts were written for, and designed to be used with the Dana DDT software. Attempting to follow them without the tool can be difficult.

Service Codes

(Codes 26, 27) - 5 Flashing Lights or DDM – Dashes “--”

Type: Very Low Pressure Reading (during tire pressure check)

| SYSTEM MODE | CONDITION | POSSIBLE CAUSES (LISTED IN ORDER OF LIKELY OCCURRENCE) |
|---------------------------------|-----------------------------------------------------------|--------------------------------------------------------------------------------------------------------------------------------------------------------------------------------------------------------------------------------------------------------------------|
| System waits to check pressures | Faulty pneumatic system or extremely low pressure reading | <ul style="list-style-type: none">• Open air line between PCU and wheel valve• Crimped or plugged line between supply tank and PCU• Pressure switch failure, shorted closed (single Ch. system)• PCU failure (not likely) |

Tire Pressure Check

The Central Tire Inflation System is not continuously pressurized; pressure checks occur on a periodic basis. During tire pressure checks, the system delivers compressed air to each channel for approximately two seconds while monitoring the pressure in that channel until stable.

Components and causes for this code include:

- **Air Lines:** damaged or disconnected
- **Supply Air:** restricted flow
- **Pressure Switch:** failure (single Ch.PCU)

Description

A “Low Pressure” code indicates an extreme low pressure reading while trying to measure the tire pressures. The most likely cause is an open line which would have a clearly audible leak during a pressure check. A secondary cause could be a faulty air delivery system or Pneumatic Control Unit [PCU].

Code 26: Single channel PCU

Code 26: Two channel PCU (Front)

Code 27: Two channel PCU (Rear)

To correctly diagnose faulty components, connect the Diagnostic Tool (see “[Diagnostics](#)” on page 13” for test equipment and descriptions) and follow the procedure in “[\(Codes 26, 27\) - Low Pressure](#)” on page 24.

See “[Troubleshooting Tips](#)” on page 22 for assistance on diagnosing issues.

Service Codes

(Codes 26, 27) - Low Pressure

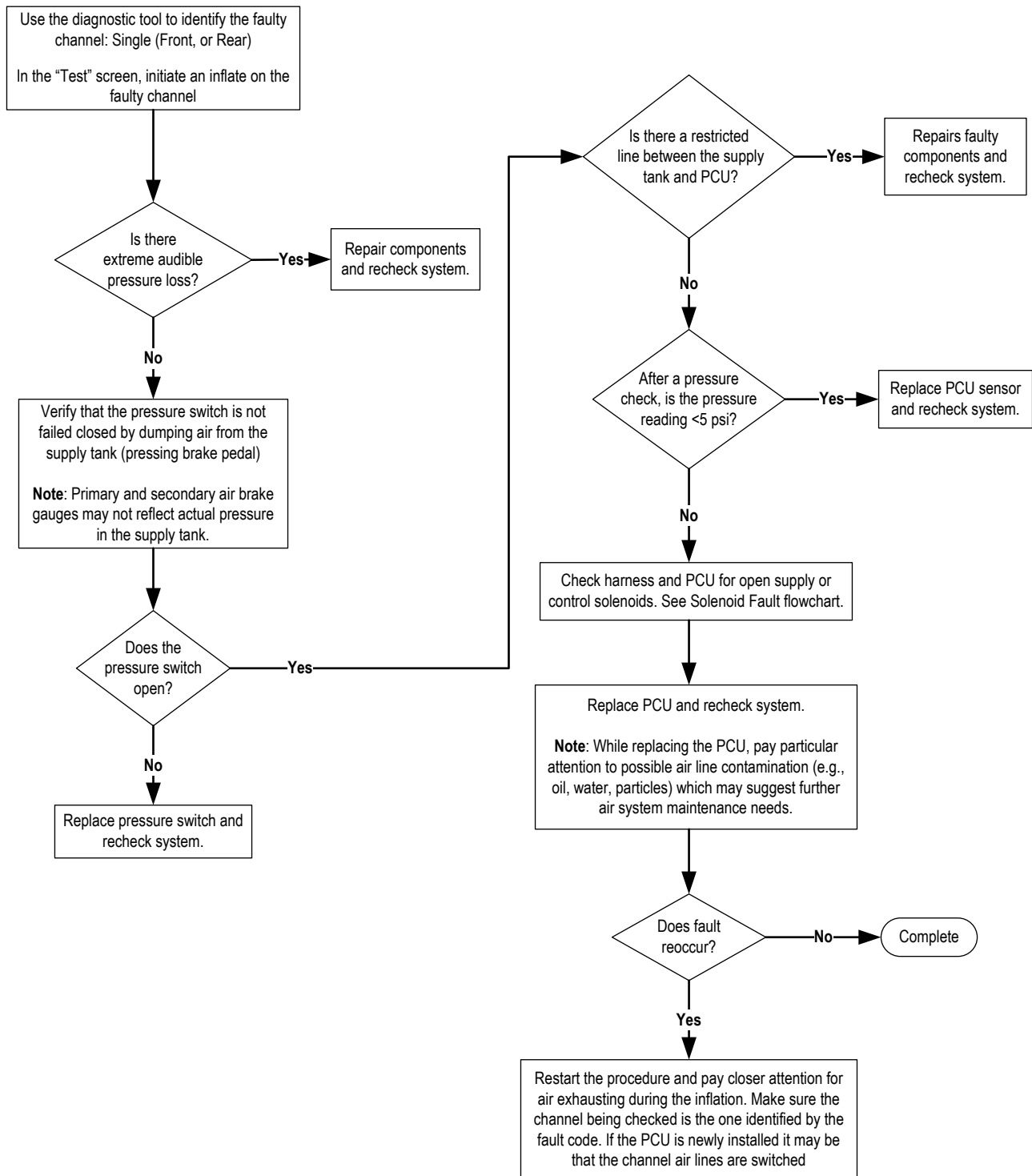

Service Codes

(Code 31) - 5 Flashing Lights or DDM – Dashes "--"

Type: Pressure Switch (Failed as Closed)

| SYSTEM MODE | CONDITION | POSSIBLE CAUSES (LISTED IN ORDER OF LIKELY OCCURRENCE) |
|---------------------|---------------------------------------------------------|---------------------------------------------------------------------------------------------------------------------------------------------------------------------------------------------------|
| Pressure check only | Pressure switch shorted or won't open. 2 Ch PCU Only | <ul style="list-style-type: none"> Pressure switch wire shorted to ground Faulty pressure switch (failed closed) Faulty PCU (leaks air during supply tank check) |

Tire Pressure Check

The Central Tire Inflation System is not continuously pressurized; pressure checks occur on a periodic basis.

During tire pressure checks, the system delivers compressed air to each channel for approximately two seconds while monitoring the pressure in that channel until stable.

ECU Harness Connector

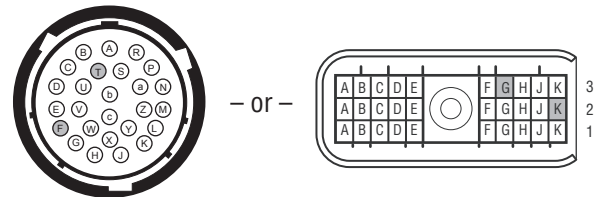

Description

A "Pressure Switch" code displays if system air pressure is inadequate to perform a tire pressure check, yet the pressure switch status is "closed."

This occurs when the pressure switch will not open. The components that can cause the pressure switch to remain closed include:

- Pressure switch wire shorted to ground
- Faulty pressure switch (failed closed)

To correctly diagnose faulty components, connect the Diagnostic Tool (see "Diagnostics" on page 13 for test equipment and descriptions) and follow the procedure in "(Code 31) - Pressure Switch" on page 26.

See "Troubleshooting Tips" on page 22 for assistance on diagnosing issues.

Service Codes

(Code 31) - Pressure Switch

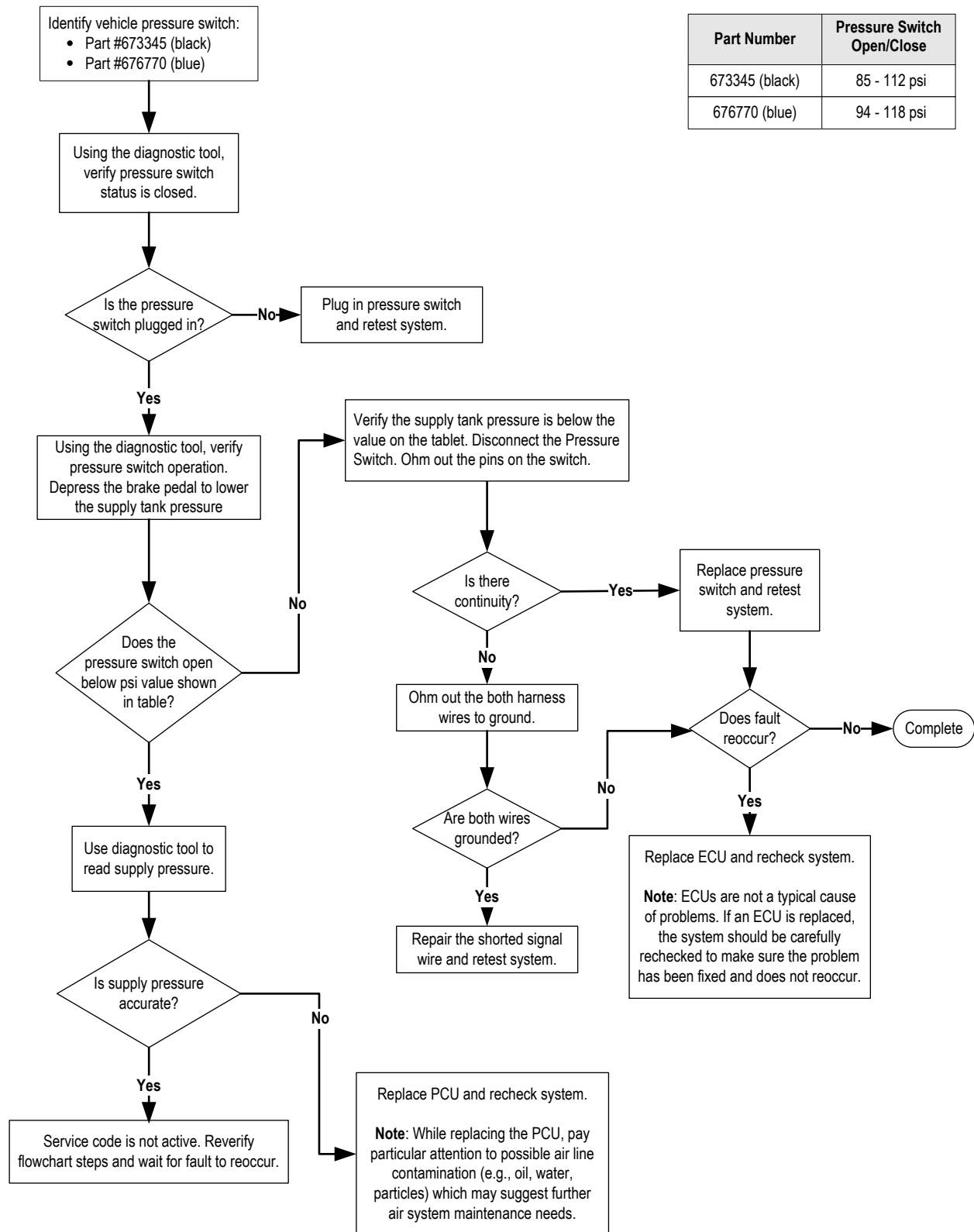

| Part Number | Pressure Switch Open/Close |
|----------------|-------------------------------|
| 673345 (black) | 85 - 112 psi |
| 676770 (blue) | 94 - 118 psi |

Service Codes

(Code 32) - 5 Flashing Lights or DDM – Dashes “--”

Type: Low Air Supply

| SYSTEM MODE | CONDITION | POSSIBLE CAUSES (LISTED IN ORDER OF LIKELY OCCURRENCE) |
|---------------------------------|----------------------------------------------------------|-----------------------------------------------------------------------------------------------------------------------------------------------------------------------------------------------------------------------------------------------------------------------------------------------------------------------------|
| System waits to check pressures | Pressure switch won't close or the supply reading is low | <ul style="list-style-type: none"> Compressor governor cut out set too low Pressure switch unplugged or broken wire Faulty pressure switch Open or leaking line from supply tank to PCU Air dryer needs service Crimped or blocked line from supply tank to PCU |

Tire Pressure Check

The Central Tire Inflation System is not continuously pressurized; pressure checks occur on a periodic basis.

During tire pressure checks, the system delivers compressed air to each channel for approximately two seconds while monitoring the pressure in that channel until stable.

Description

A “Low Air Supply” code displays if system air pressure is inadequate to perform a tire pressure check. This code is active if the vehicle has been driven for a determined time and the pressure switch did not close or the supply reading remains low.

Components that can cause the pressure switch to remain open include:

- Compressor governor:** cutout set too low
- Pressure switch:** unplugged or faulty
- Wires:** broken or open
- Airlines:** open or leaking from, supply tank to PCU
- Air Dryer:** restricted
- Airlines:** crimped or blocked, supply tank to PCU

To correctly diagnose faulty components, connect the Dana DDT tool and follow the flow chart on .

To correctly diagnose faulty components, connect the Diagnostic Tool (see “Diagnostics” on page 13 for test equipment and descriptions) and follow the procedure in “(Code 32) - Low Air Supply” on page 28.

See “Troubleshooting Tips” on page 22 for assistance on diagnosing issues.

Pressure Switch Harness Connector

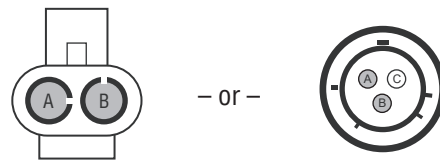

– or –

ECU Harness Connector

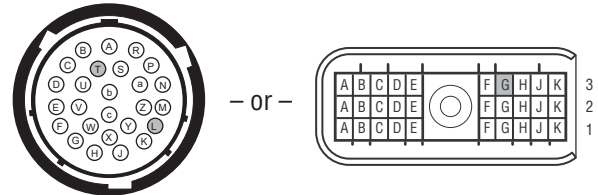

– or –

Service Codes

(Code 32) - Low Air Supply

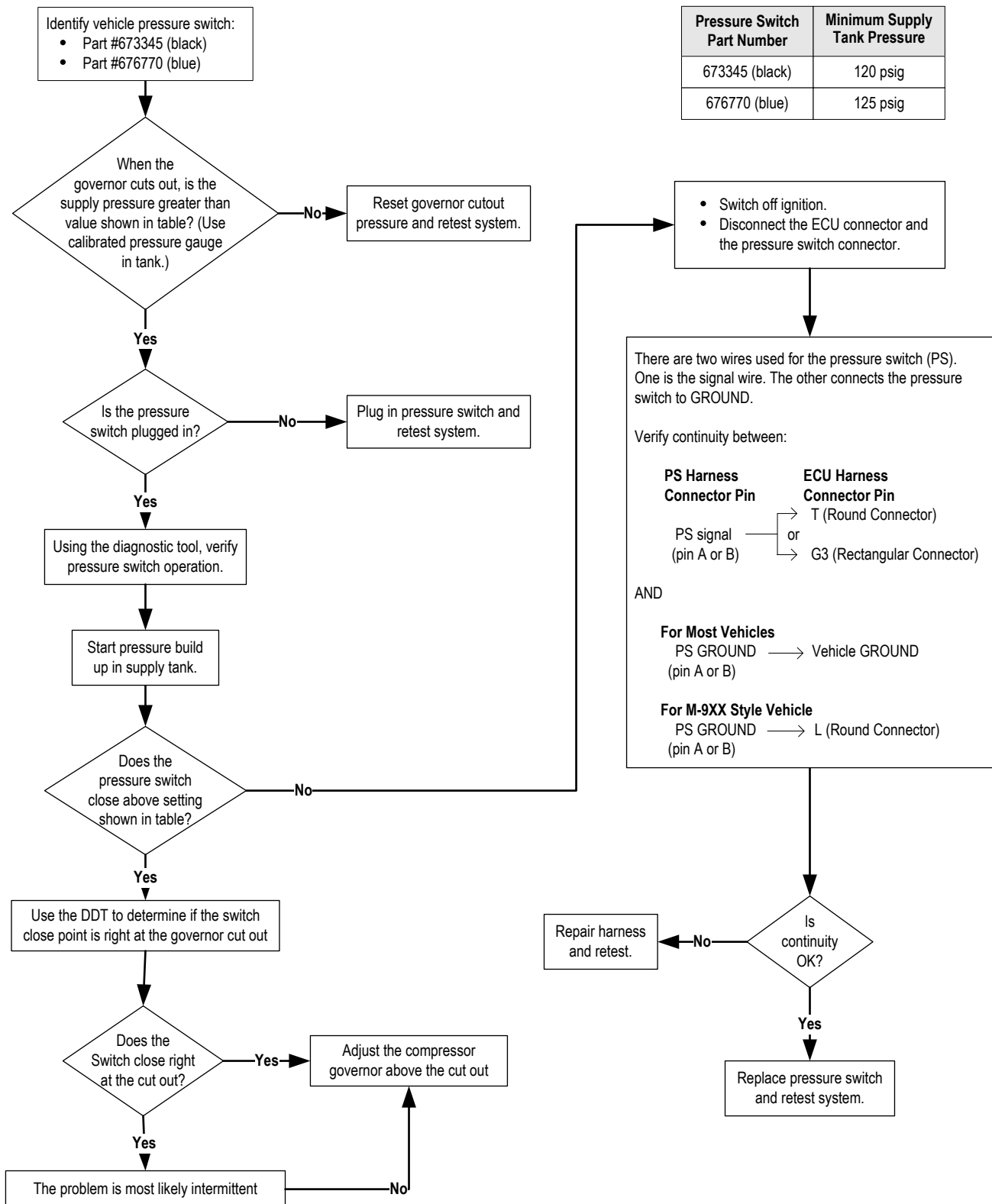

| Pressure Switch Part Number | Minimum Supply Tank Pressure |
|-----------------------------|------------------------------|
| 673345 (black) | 120 psig |
| 676770 (blue) | 125 psig |

Service Codes

(Code 34) - 5 Flashing Lights or DDM – Dashes “--”

Type: PCU Sensor

| SYSTEM MODE | CONDITION | POSSIBLE CAUSES (LISTED IN ORDER OF LIKELY OCCURRENCE) |
|--------------|------------------------------|----------------------------------------------------------------------------------------------------------------------------------------------------------------------------------------------------------------------------------------------------------------------|
| No operation | No PCU sensor reading (Null) | <ul style="list-style-type: none"> • Sensor electrically disconnected • Pressure signal wire open or shorted to ground • PCU sensor VREF wire open or shorted to ground • Faulty sensor • Faulty ECU (not likely) |

Description

A “Pneumatic Control Unit (PCU) Sensor” code occurs when the Electronic Control Unit (ECU) receives an unusually high or low reading from the PCU sensor. A diagnostic tool will specify which of the two conditions is responsible for setting the code.

Initial troubleshooting steps involve checking for a shorted-to-ground or an open PCU sensor circuit.

If the circuits check out OK, secondary causes could involve a faulty sensor or a faulty ECU.

To correctly diagnose faulty components, connect the Diagnostic Tool (see “Diagnostics” on page 13 for test equipment and descriptions) and follow the procedure in “(Code 34) - PCU Sensor” on page 30.

See “Troubleshooting Tips” on page 22 for assistance on diagnosing issues.

PCU Sensor Harness Connector

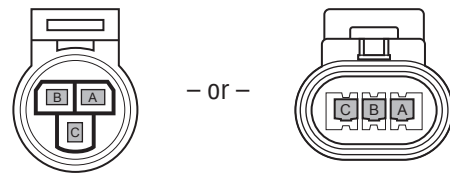

ECU Harness Connector

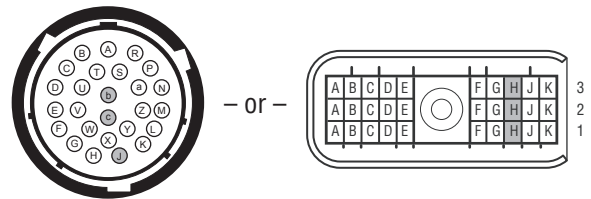

Service Codes

(Code 34) - PCU Sensor

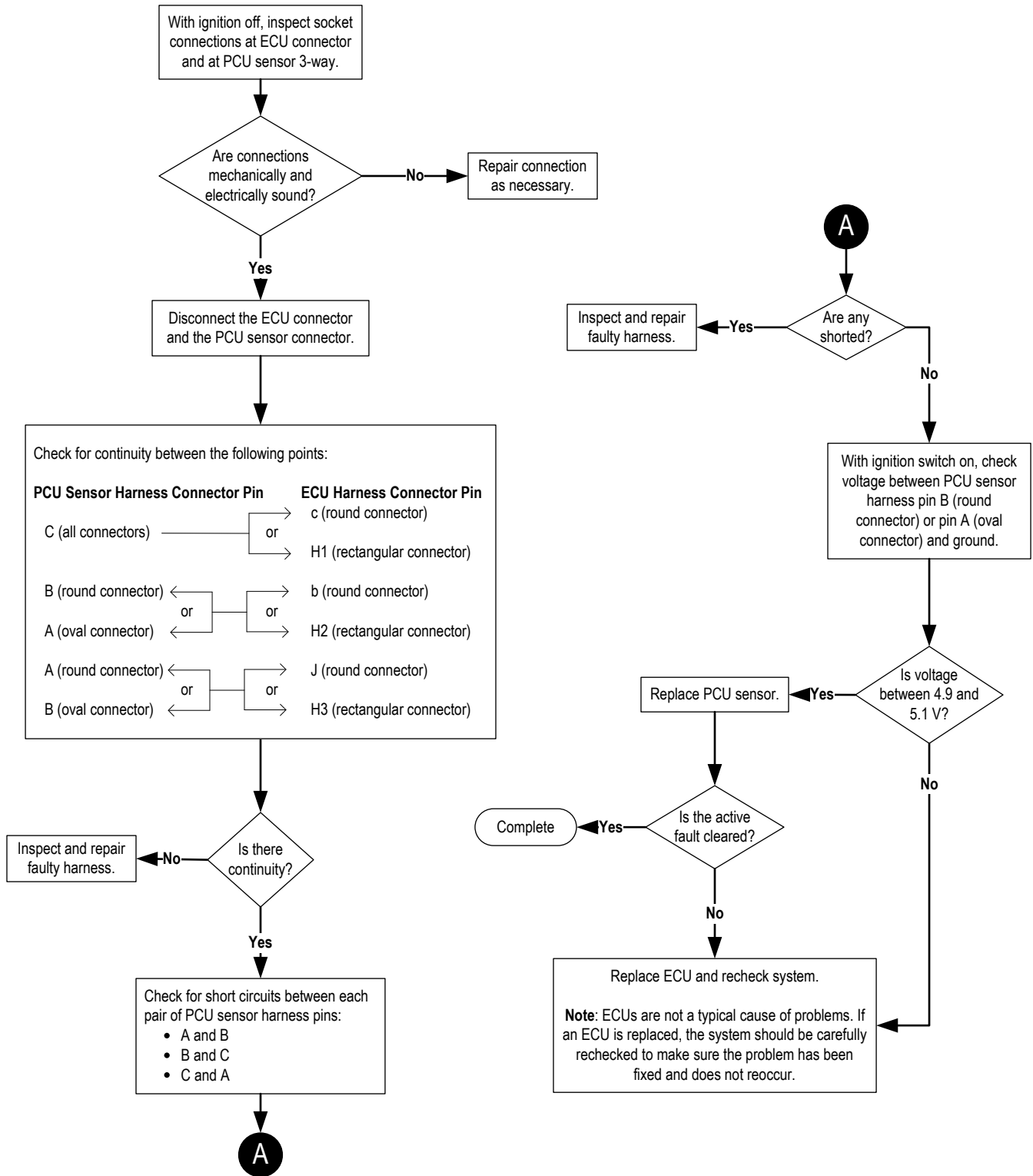

Service Codes

(Code 35) - 5 Flashing Lights or DDM – Dashes “--”

Type: Atmospheric

| SYSTEM MODE | CONDITION | POSSIBLE CAUSES (LISTED IN ORDER OF LIKELY OCCURRENCE) |
|---------------------------------|-------------------------------------------------------|---------------------------------------------------------------------------------------------------------------------------------------------------------------------------------------------------------------------------------------------------------|
| System waits to check pressures | Pressure reading is out of range when PCU is “vented” | <ul style="list-style-type: none"> • Poor ground connection to PCU sensor • Frozen water or other contaminant in PCU sensor • Faulty PCU sensor • Plugged PCU exhaust vent • Faulty PCU (not likely) |

Tire Pressure Check

The Central Tire Inflation System is not continuously pressurized; pressure checks occur on a periodic basis.

During tire pressure checks, the system delivers compressed air to each channel for approximately two seconds while monitoring the pressure in that channel until stable.

Description

When the system powers up and before pressure checks, the system will check the atmospheric pressure. An “Atmospheric” fault is logged if this reading is out of range. If the fault is logged but not active it means the system recovered automatically.

Components and causes for this code include:

- **Wiring:** short to ground, broken, poor connection
- **Sensor:** faulty or contaminated
- **PCU:** plugged vent hose
- **PCU:** leaking channel (not likely)

To correctly diagnose faulty components, connect the Diagnostic Tool (see “Diagnostics” on page 13 for test equipment and descriptions) and follow the procedure in “(Code 35) - Atmospheric” on page 32.

See “Troubleshooting Tips” on page 22 for assistance on diagnosing issues.

PCU Sensor Harness Connector

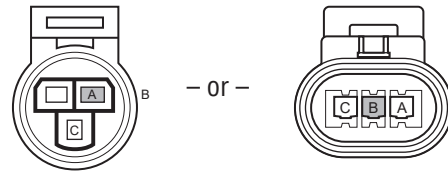

ECU Harness Connector

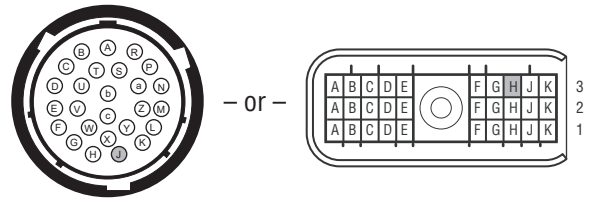

Service Codes

(Code 35) - Atmospheric

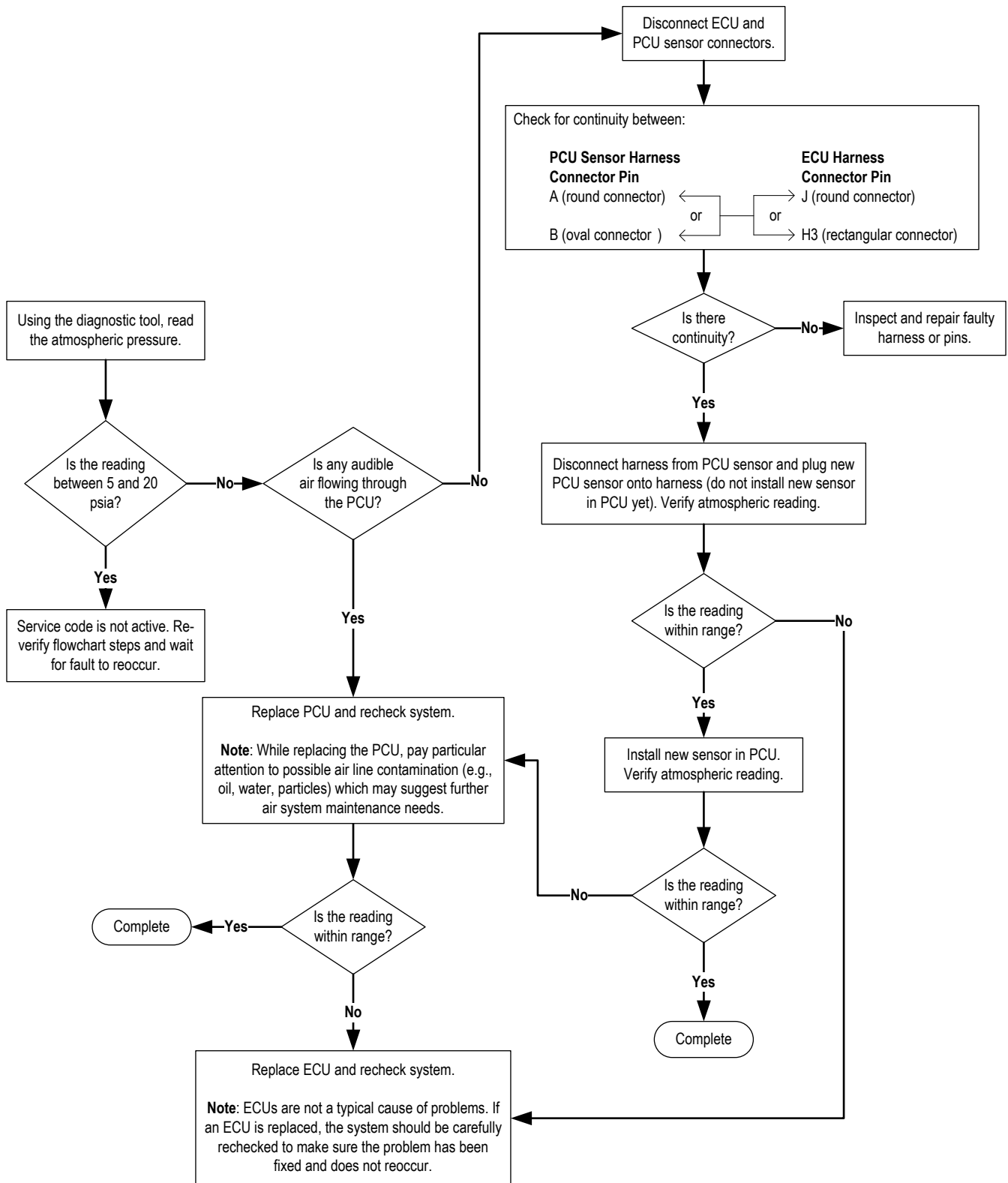

Service Codes

(Code 14) - 5 Flashing Lights or DDM – Dashes "--"

Type: Deflate Trend

| SYSTEM MODE | CONDITION | POSSIBLE CAUSES (LISTED IN ORDER OF LIKELY OCCURRENCE) |
|--------------|-------------------------------------------|----------------------------------------------------------------------------------------------------------------------------------------------------------------------------------------------------------------------------------------------------------------------------------------|
| Inflate only | Failure to deflate properly (any channel) | <ul style="list-style-type: none">• Restricted wheel valve tire ports: Plugged filters, schraders installed, plugged hose• Plugged or restricted QRV vents• Wheel internal ports clocked wrong (Integrated WVs only)• Faulty PCU (not likely) |

Description

A "Deflate Trend" code displays when the system has determined that a deflate sequence is not functioning correctly. This is the result of either the system failing to lower the tires even a small amount of the desired pressure drop or a pressure increase during a deflation. On 2-channel systems, deflation will be prevented on both channels.

Note: All tires on the effect channel should not be deflating.

Components and causes for this code include:

- **Wheel Valves:** plugged filters, plugged hoses
- **Wheels:** Schrader inserts installed, internal ports misaligned or blocked
- **Wiring:** PCU intermittent wire connection
- **PCU:** contaminated or faulty

To correctly diagnose faulty components, connect the Diagnostic Tool (see "[Diagnostics](#)" on page 13 for test equipment and descriptions) and follow the procedure in "[\(Code 14\) - Deflate Trend](#)" on page 34.

See "[Troubleshooting Tips](#)" on page 22 for assistance on diagnosing issues.

Service Codes

(Code 14) - Deflate Trend

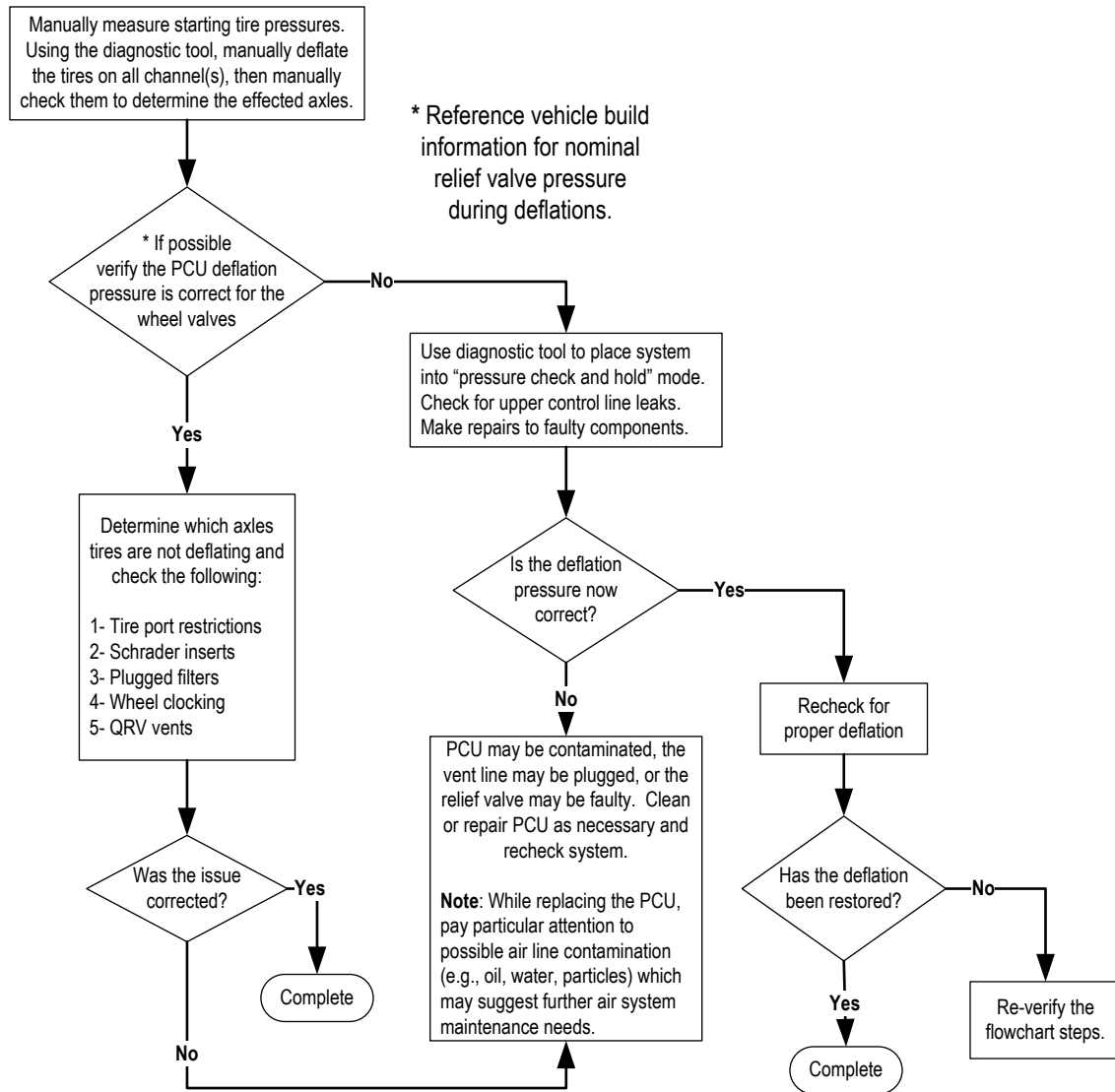

Service Codes

(Codes 36, 37) - 5 Flashing Lights or DDM – Dashes “- -” and or “Check Tires” Solid

Type: Inflate Trend

| SYSTEM MODE | CONDITION | POSSIBLE CAUSES (LISTED IN ORDER OF LIKELY OCCURRENCE) |
|---------------------|----------------------------------------------|---------------------------------------------------------------------------------------------------------------------------------------------------------------------------------------------------|
| Channel inoperative | Loss of channel pressure during an inflation | <ul style="list-style-type: none">• Severe tire damage• Damaged air lines• Leaking air seals• Leaking QRV (exhausting)• Faulty PCU (not likely) |

Description

An “Inflate Trend” code displays when tire pressure reading has dropping while inflating. Tire or airline damage has occurred, which the compressor cannot keep up with. This is a fault that typically occurs during vehicle operation and during an inflation sequence.

Code 36: Single channel PCU

Code 36: Two channel PCU (Front)

Code 37: Two channel PCU (Rear)

Components and causes for this code include:

- **Tires:** damage and leaking
- **Control lines:** damaged and leaking
- **Tire hose:** damaged and leaking
- **Air seals:** damaged and leaking
- **Quick Release Valve:** contaminated and exhausting

To correctly diagnose faulty components, connect the Diagnostic Tool (see “[Diagnostics](#)” on page 13“ for test equipment and descriptions) and follow the procedure in “[\(Codes 36, 37\) - Inflate Trend](#)” on page 36.

See “[Troubleshooting Tips](#)” on page 22 for assistance on diagnosing issues.

Service Codes

(Codes 36, 37) - Inflate Trend

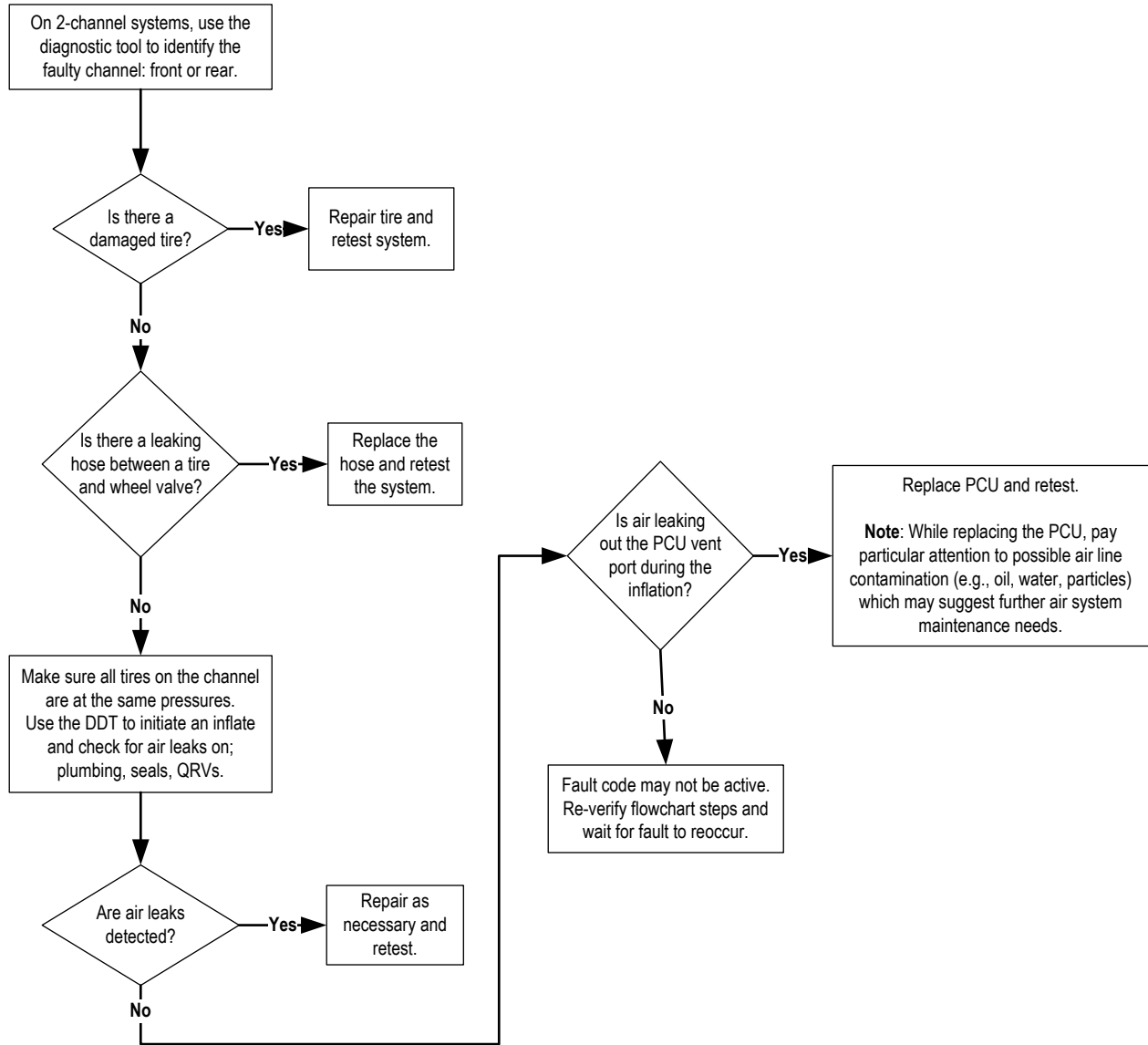

Service Codes

(Codes 44, 45) - 4 Flashing Lights or “CHECK TIRES” Flashing

Type: Tire Leak (Imbalance) Auto Run Flat mode may be enabled

| SYSTEM MODE | CONDITION | POSSIBLE CAUSES (LISTED IN ORDER OF LIKELY OCCURRENCE) |
|-------------------------------|-----------------------------------------------------------|---------------------------------------------------------------------------------------------------------------------------------------------------------------------------------------------------------------------------------------|
| Channel only checks pressures | Tire pressures significantly imbalanced or airline issues | <ul style="list-style-type: none">• Leaking upper control lines• Losing air pressure from the tire to the wheel valve• Contaminated wheel valve filters• Crimped or restricted control lines |

Tire Pressure Check

Note that the Central Tire Inflation System is not continuously pressurized; pressure checks occur on a periodic basis. During tire pressure checks, the system delivers compressed air to each channel for approximately two seconds while monitoring the pressure in that channel until stable.

Description

An “Imbalance” is caused by the pressure reading dropping from higher tires down to lower tires. The system will only log this fault if the tire pressure reading is at the desired target pressure, but the reading is unstable.

The most common condition that could trigger this fault would be if some tires were higher than the target and other tires were lower than the target on a particular channel. The range of tire pressure differential to cause this fault is a percentage of the full scale target pressure. The fault should clear when a pressure check occurs with the imbalance corrected.

There are other conditions that can cause this fault to occur when tires are not imbalanced. Upper control line air leaks can fool the system into detecting an imbalance when none exists. Plugged wheel valve filters or restricted air lines can also cause this fault to log.

Components that can cause an initial tire imbalance leading to the fault include:

- leaking tires, rims, tire hose or wheel valve

Note: When using a diagnostic tool to inflate or inflate-hold a channel with a low tire, air may be heard leaking out or the Quick Release Valves (QRV). This is caused by the imbalanced tires on that channel and should stop once the tire pressures on that channel become balanced.

To correctly diagnose faulty components, connect the Diagnostic Tool (see “[Diagnostics](#)” on page 13” for test equipment and descriptions) and follow the procedure in “[\(Codes 44, 45\) - Tire Leak \(Imbalance\)](#)” on page 38.

See “[Troubleshooting Tips](#)” on page 22 for assistance on diagnosing issues.

Service Codes

(Codes 44, 45) - Tire Leak (Imbalance)

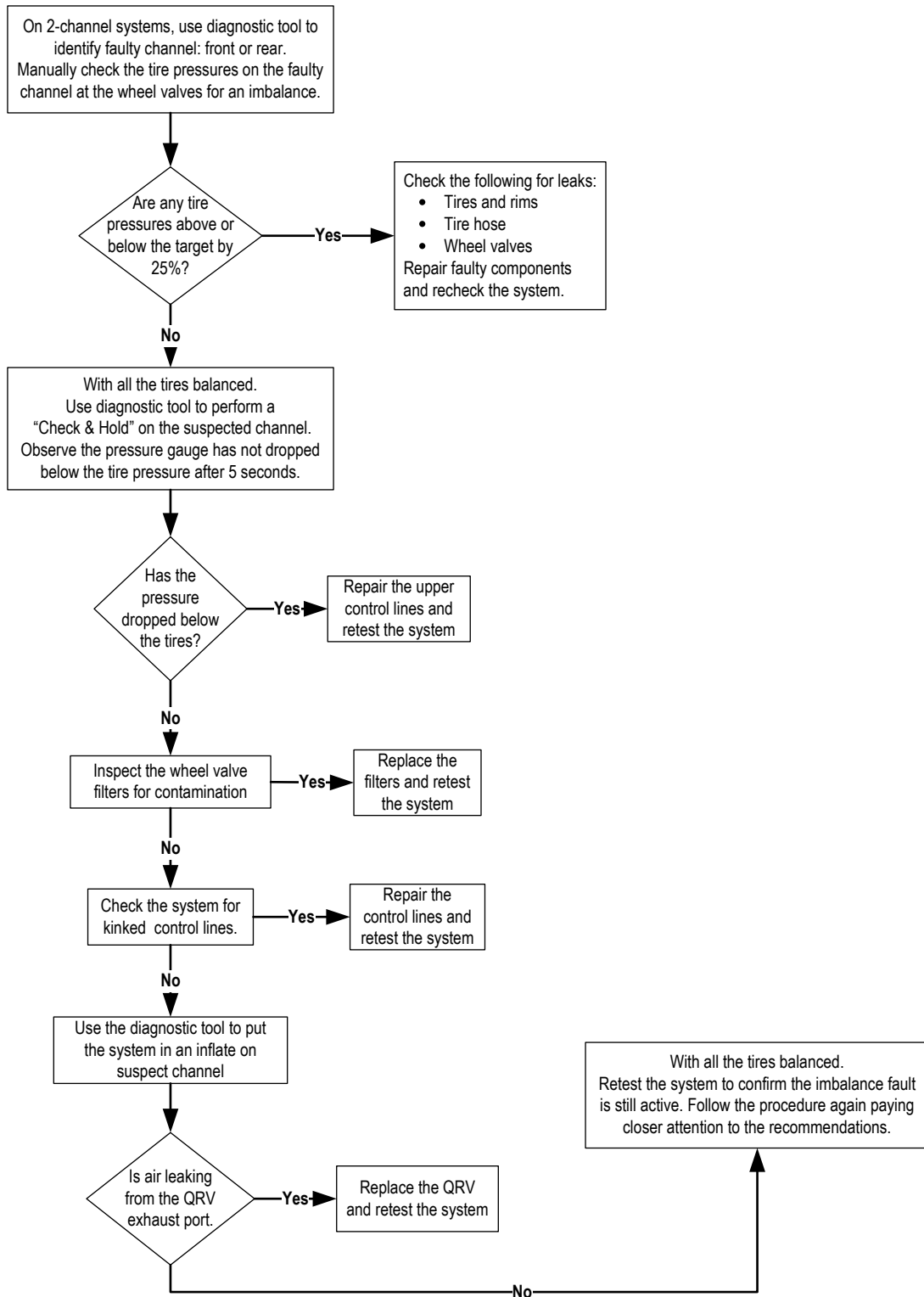

Service Codes

(Codes 41, 42) - 4 Flashing Lights or “CHECK TIRES” Flashing

Type: Tire Leak (Confirm)

Note: RUN FLAT overrides this fault.

| SYSTEM MODE | CONDITION | POSSIBLE CAUSES (LISTED IN ORDER OF LIKELY OCCURRENCE) |
|----------------------------------|------------------------------|------------------------------------------------------------------------------------------------------------------------------------------------------------------------------------------------------------------------------------------------------------------------------------------------------------------------------------|
| Inflate Only on effected channel | Channel confirmation failure | <ul style="list-style-type: none">• Wheel valves not closing properly• Damaged or leaking tire or tire hose• Extreme cold temperatures• Restricted air line or passage between QRV and wheel valve• Plugged or restricted PCU vent line• Plugged or restricted QRV vent |

Tire Pressure Check

The Central Tire Inflation System is not continuously pressurized; pressure checks occur on a periodic basis. During tire pressure checks, the system delivers compressed air to each channel for approximately two seconds while monitoring the pressure in that channel until stable.

Note: If the pressure loss is due to air dumping out QRV's, there are no tire or line leaks, and it is extremely cold, the condition may be temporarily corrected by venting the wheel valve cover screws (loosen screw and re-tighten). Make sure the CTIS is not functioning when venting screws.

Description

Codes - **41** (Single Channel PCU), **41** (Two Channel PCU Front), **42** (Two Channel PCU Rear) If the system has determined the tires are losing air during the 30 second confirmation check the following criteria applies:

1. If the tire pressure loss is **Minor**:

- 1.1. The system will re-inflate the tires to confirm 6 times
- 1.2. After the 6 inflations the system will not inflate again but wait for another 30 seconds
- 1.3. After the 30 seconds if the tire pressure continued to drop, the system will log the “Tire Leak” (Confirm) fault
- 1.4. The system will then turn on 4 Flashing LEDs or “Check Tires”, and send the Fault Code message on the CAN bus. The system will then go to “Maintain” for 15 minutes and “Inflate Only” mode for the effected channel (see Important below)

 **IMPORTANT:** Upon a warning indication the vehicle operator is responsible for determining the cause for the pressure loss. The operator can also engage “Run Flat” as a limp home mode.

A confirmation failure can be caused by:

- Leaking, contaminated or old wheel valves
- Leaking air line between the wheel valve and tire
- Damaged or leaking tire
- Restricted air passage between QRV and wheel valve
- Plugged or restricted PCU vent line
- Plugged or restricted QRV vent

To correctly diagnose faulty components, connect the Diagnostic Tool (see “Diagnostics” on page 13 for test equipment and descriptions) and follow the procedure in “(Codes 41, 42) - Tire Leak (Confirm)” on page 40.

See “Troubleshooting Tips” on page 22 for assistance on diagnosing issues.

Service Codes

(Codes 41, 42) - Tire Leak (Confirm)

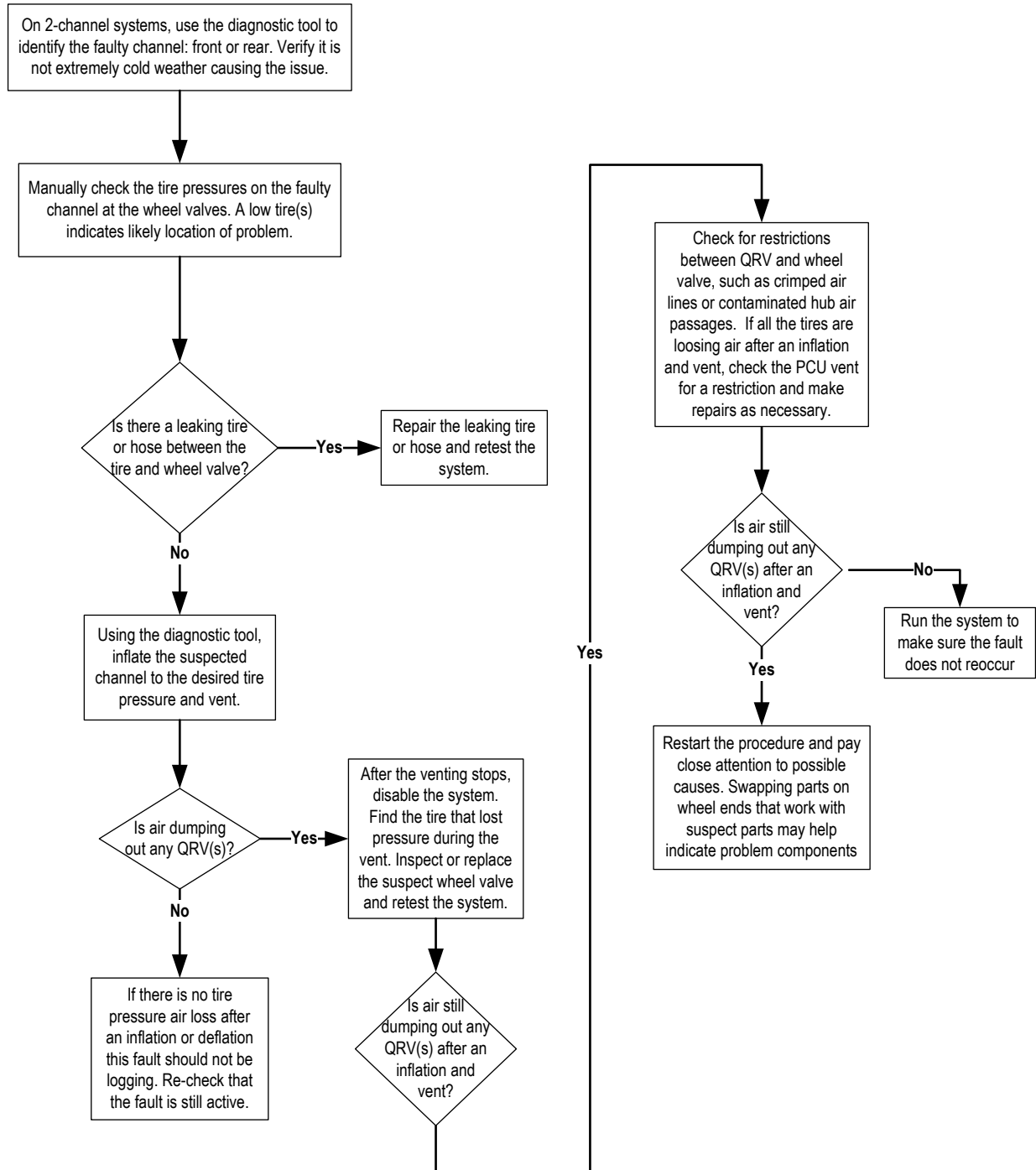

Service Codes

(Codes 23, 24) - 2 Terrain Lights on Solid or DDM – Dashes “- -”

Type: Between Modes

| SYSTEM MODE | CONDITION | POSSIBLE CAUSES (LISTED IN ORDER OF LIKELY OCCURRENCE) |
|---------------------|--------------|---------------------------------------------------------------------------------------------------------------------------------------------------------------------------------------------------------------------------------------|
| Pressure check only | Slow inflate | <ul style="list-style-type: none">• Faulty compressor• Restricted flow at wheel valve air filters• Crimped or plugged supply airline• Compressor governor set too low |
| Pressure check only | Slow deflate | <ul style="list-style-type: none">• Restricted flow at wheel valve air filters or valve stem• Restricted tire valve stem or hose• PCU relief valve pressure low• Restricted QRV exhaust port |

Description

A “Between Modes” occurs if a channel inflates or deflates too slowly. The maximum allotted time for an inflate is 40 minutes or 20 minutes for a deflate. The time is counted for active inflation or deflation only. On ECU’s with terrain indicator lights, the two solid lights frame the stuck pressure reading.

Slow inflation

The most likely cause for a slow inflate is a faulty compressor or similar problem resulting in inadequate air supply to the PCU. If the compressor is significantly low, inflating with the engine at idle may cause this fault to log.

If the system is able to generate a sufficient air supply, a “Between Modes Slow Inflate” code means that an air leak or restriction may be present.

Slow deflation

- If occurring on a single channel or axle, look for restrictions on the respective QRV vent.
- If occurring on all axles, look for restrictions on the QRV main vent if tied together.
- Extreme high temperatures at the wheel valves
- If the fault is occurring near the “Emergency” setting, the PRV deflation pressure may be too high (above the Emergency target)

Less likely causes would be:

All the wheel valve on the effected channel have become contaminated

All the wheel valve filters or tire hoses on the effected channel have become restricted.

Components that can cause this fault include:

- Wheel valve air filters
- Valve stem or hose; restricted
- PCU relief valve; faulty
- Quick Release Valve (QRV); restricted (deflation)

To correctly diagnose faulty components, connect the Diagnostic Tool (see “Diagnostics” on page 13 for test equipment and descriptions) and follow the procedure in “(Codes 23, 24) - Between Modes” on page 42.

See “Troubleshooting Tips” on page 22 for assistance on diagnosing issues.

Service Codes

(Codes 23, 24) - Between Modes

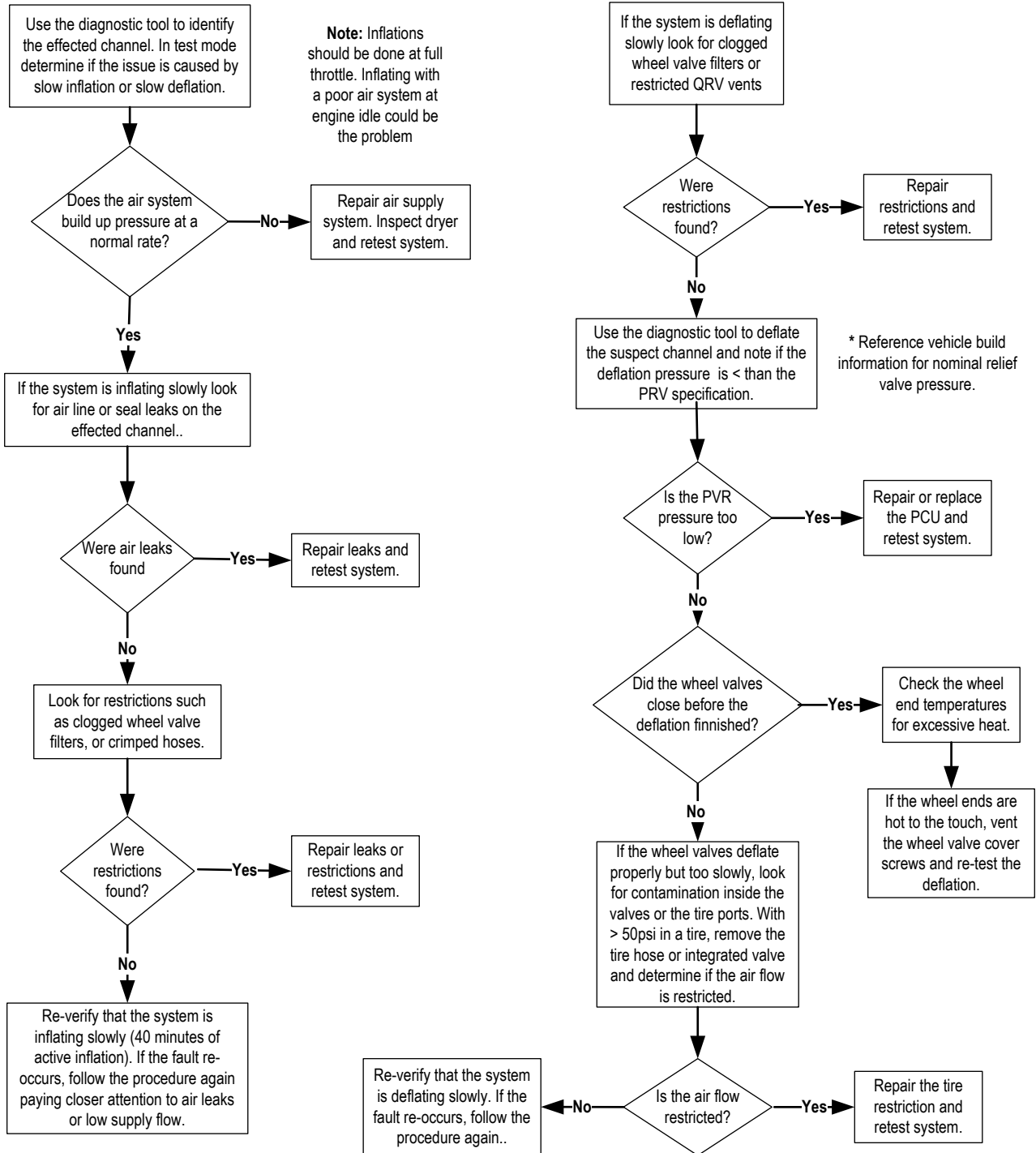

Service Codes

(Codes 11, 12, 16) - 2 Terrain Lights on Solid or DDM – Dashes “- -”

Type: Deflate Signal

| SYSTEM MODE | CONDITION | POSSIBLE CAUSES (LISTED IN ORDER OF LIKELY OCCURRENCE) |
|--------------|--------------------------------------------------------|---------------------------------------------------------------------------------------------------------------------------------------------------------------------------------------------------------------------------------------|
| Inflate only | Inadequate deflate signal in the PCU and control lines | <ul style="list-style-type: none"> Plugged or restricted PCU vent line Faulty PCU relief valve Upper control line leak (PCU to QRV) Faulty PCU Poor ground connector to PCU sensor |

Description

A “Deflate Signal” indicates inadequate deflate signal in the Pneumatic Control Unit (PCU) or failure to sustain the signal in the control lines of a given channel.

When a deflate is requested, the system drops the control line pressure to a preset level which is established by the PCU’s relief valve. 2-channel systems may start separate channels at different times.

If the proper pressure (vehicle specific, but typically 8-18 psi) cannot be maintained by the PCU, either a Channel Deflate Loss or Loss of Deflate signal code is logged.

On 2-channel systems, if the relief valve pressure (deflate signal) cannot be maintained while both channels are deflating, the system will attempt to deflate the channels individually and will log “Deflate Signal” codes for an individual channel with a problem.

Components that can cause the fault:

- PCU; plugged vent line
- PCU Relief Valve; faulty
- Upper Airline: leaking PCU to QRV
- PCU: faulty (not likely)

To correctly diagnose faulty components, connect the Diagnostic Tool (see “Diagnostics” on page 13 for test equipment and descriptions) and follow the procedure in “(Codes 11, 12, 16) - Deflate Signal” on page 44.

See “Troubleshooting Tips” on page 22 for assistance on diagnosing issues.

PCU Sensor Harness Connector

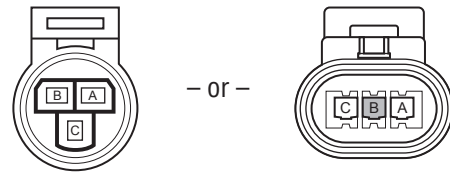

ECU Harness Connector

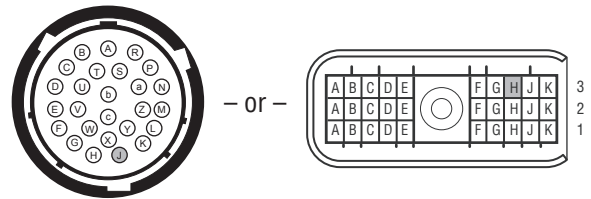

Service Codes

(Codes 11, 12, 16) - Deflate Signal

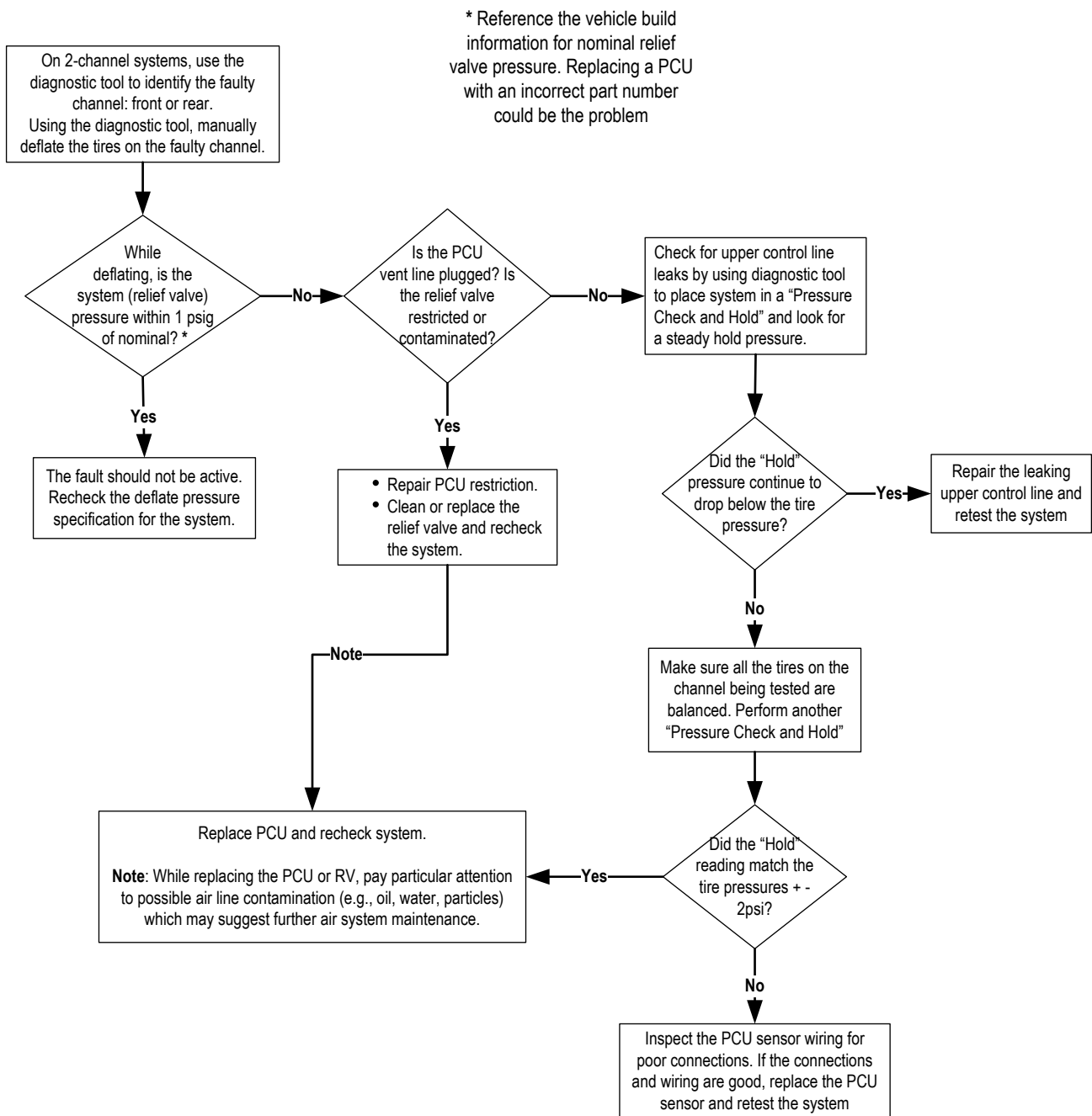

Service Codes

(Codes 51, 52, 54, 55, 56) - No Terrain Lights or DDM – Dashes “- -”

Type: PCU Solenoid (Front, Rear, Supply, Deflate, Control)

| SYSTEM MODE | CONDITION | POSSIBLE CAUSES (LISTED IN ORDER OF LIKELY OCCURRENCE) |
|------------------------------------------------|------------------------------------------------|-------------------------------------------------------------------------------------------------------------------------------------------------------------------------------------------------------------------------------------|
| No Operation Terrain lights are blanked out | PCU solenoid failed electrical diagnostic test | <ul style="list-style-type: none"> • Solenoid wire broken or open • Solenoid wire shorted to ground • Solenoid wire shorted to power • Faulty solenoid • Faulty ECU (not likely) |

Description

A “Solenoid Fault” code indicates an electrical fault in the Pneumatic Control Unit (PCU). System operation is disabled when these faults are detected. The system shuts down in a fail-safe mode and turns off the power to the solenoids.

The troubleshooting tree first tests internal solenoid circuitry. Resistance outside the specified range of 30 to 80 ohms indicates a defective solenoid. Succeeding steps check continuity of the wire harness circuits between the PCU and the Electronic Control Unit (ECU). If the problem can be traced to a faulty circuit or connector, make the necessary repairs. If the troubleshooting routine leads to a problem with the solenoid itself, the PCU must be repaired or replaced. If both the solenoid and the circuitry check out OK, the ECU is faulty.

To correctly diagnose faulty components, connect the Diagnostic Tool (see “Diagnostics” on page 13 for test equipment and descriptions) and follow the procedure in “(Codes 51, 52, 54, 55, 56) - PCU Solenoid” on page 46.

See “Troubleshooting Tips” on page 22 for assistance on diagnosing issues.

Note: If all codes are set the PCU is likely unplugged.

PCU Component Connector

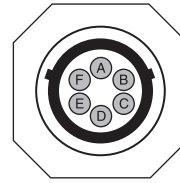

PCU Harness Connector

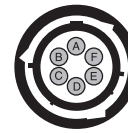

ECU Harness Connector

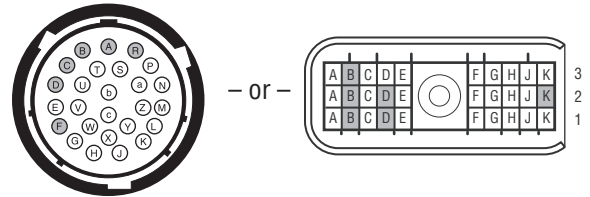

Service Codes

(Codes 51, 52, 54, 55, 56) - PCU Solenoid

Use diagnostic tool to identify which solenoid to troubleshoot.

- Switch off ignition.
- Disconnect harness at PCU connector.

Measure solenoid coil resistance on PCU connector for identified coil. Resistance should be 30-80 ohms.

| | |
|-----------------------------|-----------------------------|
| On 1-Channel Systems | On 2-Channel Systems |
| Control: B – D | Control: A – D |
| Deflate: A – E | Deflate: A – E |
| Supply: A – F | Supply: A – F |
| | Front: A – C |
| | Rear: A – B |

Are resistance measurements OK?

No → Repair or replace connections, coils or PCU.

- Check for shorts between PCU connector pins D, E, F and vehicle ground.
- On 2-channel systems, check for shorts between PCU connector pins C, B and vehicle ground.

Are any pins shorted to ground?

Yes → Repair or replace connections, coils or PCU.

1. Disconnect ECU harness connector.
2. Check for continuity between:

| | |
|-------------------------------------------|----------------------------------------------------------------------------------------------------------------------------------------------------------------------|
| PCU Solenoid Harness Connector Pin | ECU Harness Connector Pin |
| A | <ul style="list-style-type: none"> → F (flange round connector) → G (M939 round connector) or → K2 (rectangular connector) |
3. On 1-channel systems, also check for continuity between:

| | |
|-------------------------------------------|---------------------------------------------------------------------------------------------------------------------------------------------------------------|
| PCU Solenoid Harness Connector Pin | ECU Harness Connector Pin |
| B | <ul style="list-style-type: none"> → F (round connector) → W (M939 round connector) or → K2 (rectangular connector) |
4. Check continuity of harness pin(s) shown in table for given service code (PCU harness connector to ECU harness connector).

Each code matches one specific solenoid. When the troubleshooting instructions refer to connector test points, use chart to select the pin test point for use with the particular fault code you are diagnosing.

| Fault Code | Supply (54) | Deflate (55) | Control (56) | Front (51) | Rear (52) |
|-------------------------------------|-------------|--------------|--------------|------------|-----------|
| PCU Harness Connector | F | E | D | C | B |
| ECU Harness Connector (round) | B | C | R | D | A |
| ECU Harness Connector (rectangular) | B1 | B2 | B3 | D1 | D2 |

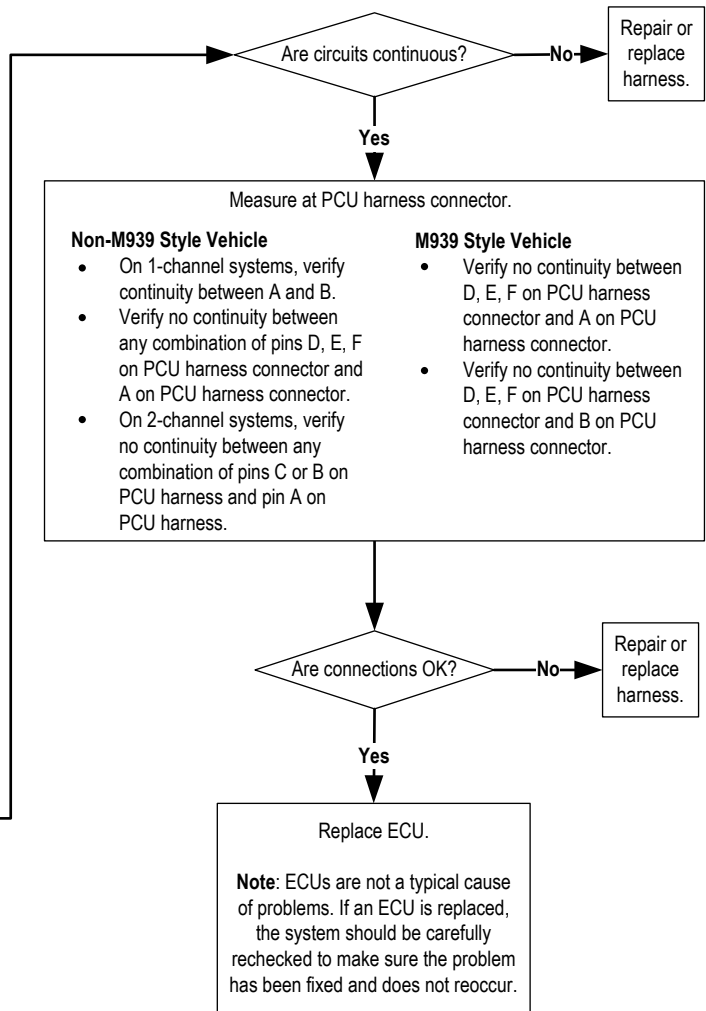

Service Codes

(Code 17) - No Terrain Lights or DDM – Blank Display

Type: Power

| SYSTEM MODE | CONDITION | POSSIBLE CAUSES (LISTED IN ORDER OF LIKELY OCCURRENCE) |
|--------------|--------------------|---------------------------------------------------------------------------------------------------------------------------------------------------------------------------------------------------------------------------------------|
| No Operation | Power out of range | <ul style="list-style-type: none"> • Low voltage • Poor ground connection to ECU • Poor power connection to ECU • High vehicle electrical system voltage • Faulty ECU (not likely) |

Description

A “Power” code indicates a power fault and sets when the system power is outside a 24-volt system’s acceptable range of 18 to 32 Volts. The fault could be caused by low battery.

In inspecting circuits and connections for a Power code, pay particular attention to a bad ground connection, which could be causing the fault.

To correctly diagnose faulty components, connect the Diagnostic Tool (see “Diagnostics” on page 13 for test equipment and descriptions) and follow the procedure in “(Code 17) - Power” on page 48.

See “Troubleshooting Tips” on page 22 for assistance on diagnosing issues.

ECU Harness Connector

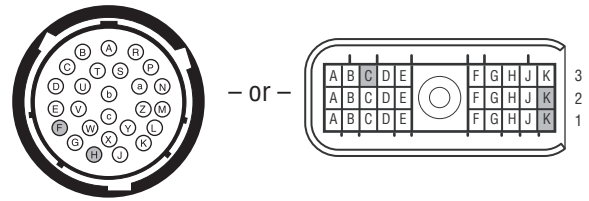

Service Codes

(Code 17) - Power

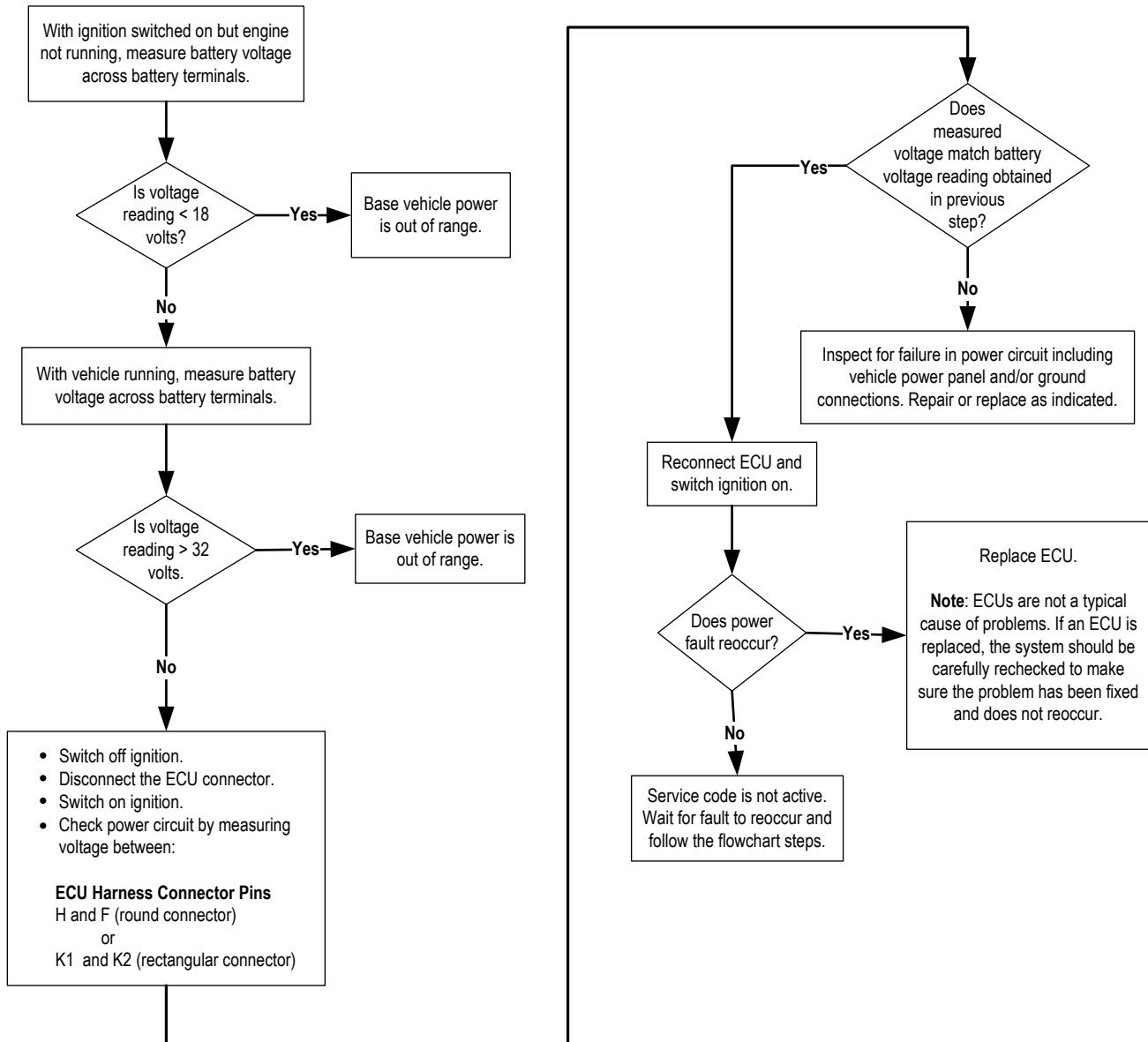

Service Codes

(Code 75) - DDM – Dashes “- -”

Type: Display Control Communications

| SYSTEM MODE | CONDITION | POSSIBLE CAUSES (LISTED IN ORDER OF LIKELY OCCURRENCE) |
|--------------|--------------------|-----------------------------------------------------------------------------------------------------------------------------------------------------------------------------------------------------------------------------------|
| Inflate Only | Blank Display | <ul style="list-style-type: none"> No power to DDM No ground connection to DDM System voltage out of range (9-32 volts DC) |
| Inflate Only | DDM displays “- -” | <ul style="list-style-type: none"> DDM to ECU wires open DDM to ECU wires shorted to ground, power or together Faulty Driver Display Module Faulty Electronic Control Unit (not likely) |

Description

Code 75 indicates a communication problem between the Electronic Control Unit (ECU) and the Driver Display Module.

All of the troubleshooting steps for code 75 involve checking the condition of Electronic Control Unit and DDM circuits. If no circuit problems are found, code 75 indicates either a faulty DDM or a faulty Electronic Control Unit.

To correctly diagnose faulty components, connect the Diagnostic Tool (see “Diagnostics” on page 13 for test equipment and descriptions) and follow the procedure in “(Code 75) - Display Control Communications” on page 50.

See “Troubleshooting Tips” on page 22 for assistance on diagnosing issues.

DDM Display Harness Connector

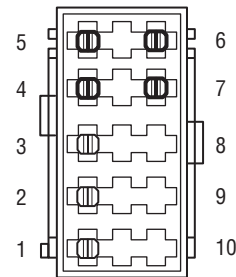

ECU Harness Connector

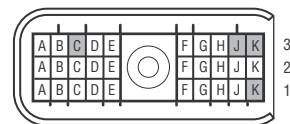

Service Codes

(Code 75) - Display Control Communications

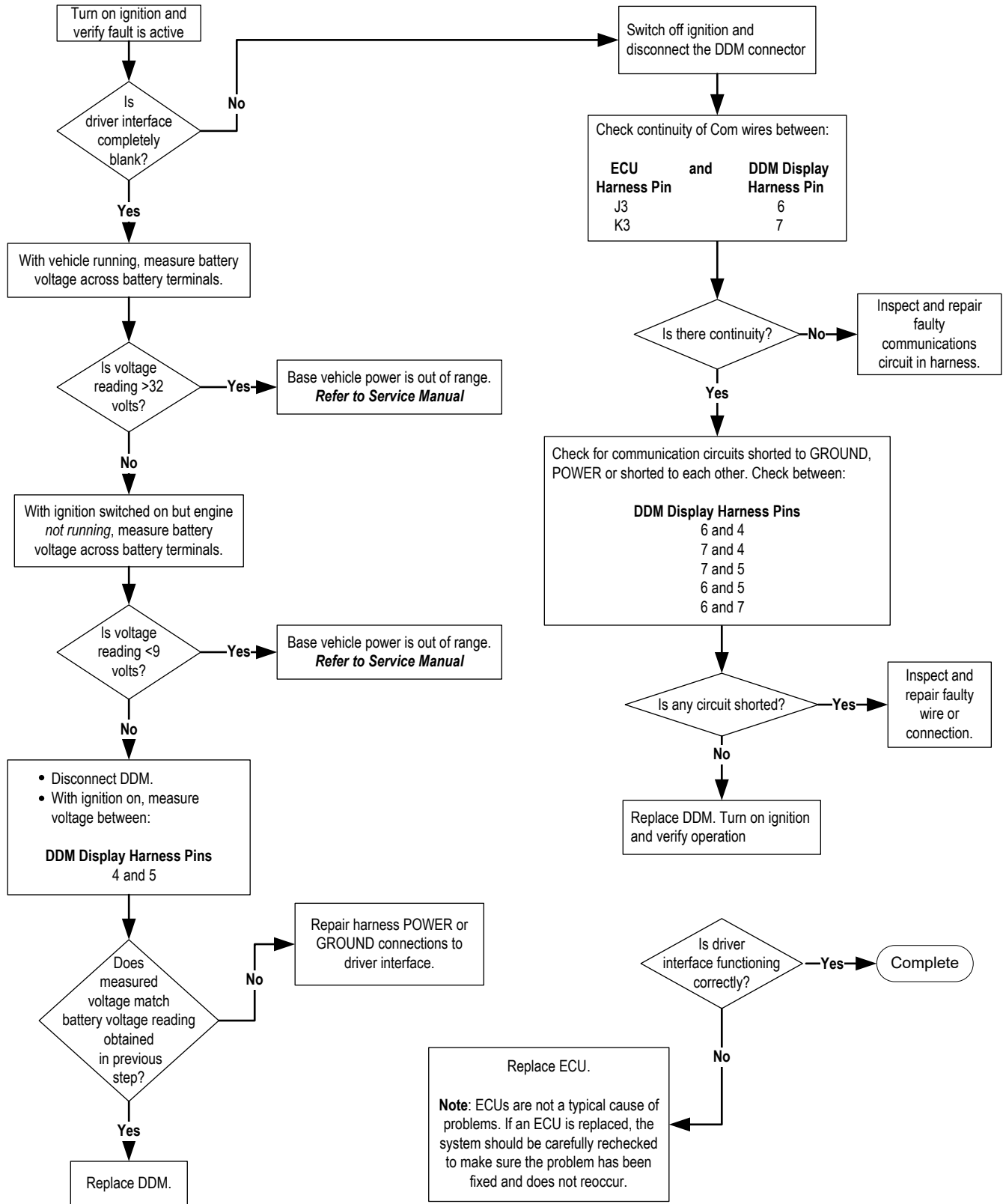

Service Codes

Sequentially Flashing Lights or “dL” displayed on DDM

Type: ECU software waiting for parameter download or configuration reset

| SYSTEM MODE | CONDITION | POSSIBLE CAUSES (LISTED IN ORDER OF LIKELY OCCURRENCE) |
|--------------------------------|--------------------------------|------------------------------------------------------------------------------------------------------------------------------------------------------------------------------------------------------------------|
| Limp Home/ Normal Operation | System using default values | <ul style="list-style-type: none"> • Harness configuration requires a downloaded file • Broken or intermittent config wire connection • If equipped, unplugged config connector |

Description

Dana’s CTIS supports multiple vehicles or setups (tire pressure targets, etc.) within a single Electronic Control Unit (ECU). This allows the ECU to be moved from vehicle to vehicle and change its parameters according to vehicle type. Setups can either be selected through harness wiring configurations or “downloaded” to the ECU.

Additional modifications can be made using Dana’s PC-based diagnostic tool; typically it is the result of a system in which the harness has been selected for a downloadable configuration (customized - See [”Configuration Options” on page 70](#)), but has not yet been downloaded.

Downloading the appropriate OEM setup file will clear the display indication. A download file can be obtained from the OEM or Dana Engineering.

In some cases a reset can occur without the lights sequentially flashing. If this happens, an automatic memory reload has occurred. The system has reloaded the system defaults into the ECU memory, eliminating any customization or changes (target pressures, etc.) previously programmed.

The troubleshooting procedure involves verifying that the harness configuration selection wires are making a good connection. If the configuration wires are good, and the problem repeatedly occurs, the ECU may need to be replaced.

Note: Operating a vehicle where the CTIS has not been configured properly may result in poor system performance and in some cases may cause fault codes to be logged.

⚠ WARNING: If the speed calibration is not correct, CTIS safety features could be comprised.

To correctly diagnose faulty components, connect the Diagnostic Tool (see [”Diagnostics” on page 13](#) for test equipment and descriptions) and follow the procedure in [”Configuration DL/Reset” on page 52](#).

See [”Troubleshooting Tips” on page 22](#) for assistance on diagnosing issues.

ECU Harness Connector

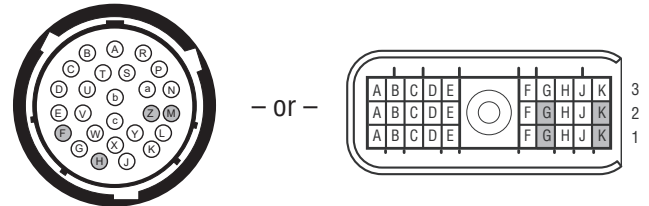

Configuration DL/Reset

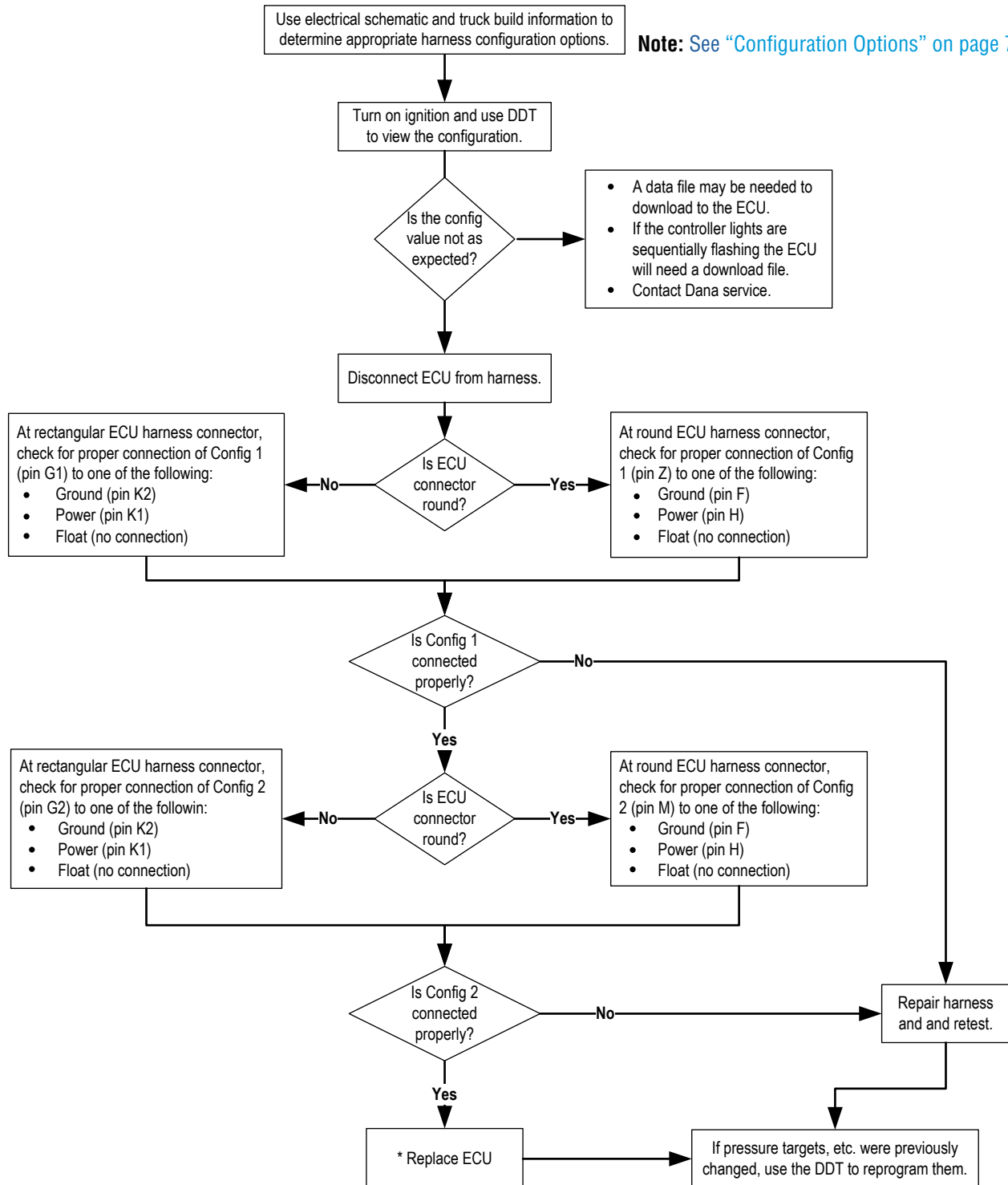

*** Note:** ECUs are not a typical cause of problems; however, if manual changes in in tire pressures and speed calibrations are frequently replaced with default values, and the wiring harness has been confirmed to be good, replacement of the ECU may be necessary.

Note: ECUs are not a typically cause of Service Codes. However, if manual changes in tire pressures, speed calibrations are frequently replaced with default values, and the wiring harness has been confirmed to be good, replacement of the ECU may be necessary.

Service Codes

(Codes 18, 76, 77) - Solid Warning Lamp or Solid “OVER SPEED”

Type: Speed Signal (ECU power cycled 50 times without a speed signal) or (No data message)

| SYSTEM MODE | CONDITION | POSSIBLE CAUSES (LISTED IN ORDER OF LIKELY OCCURRENCE) |
|------------------|----------------------------|--------------------------------------------------------------------------------------------------------------------------------------------------------------------------------------------------------------------------------------------------------------------------------------------------------------------------------------------------------------------------------------------------------------------------------------------|
| Normal Operation | No speed signal or message | <p>The vehicle has not been driven for 50 key cycles because of the following:</p> <ul style="list-style-type: none"> • Sensor disconnected or loose plug • The digital signal is no longer present • Sensor wires are open, broken or shorted • Gap not adjusted correctly on pole sensor • Faulty speed sensor • Expected data link message not received (logged in minutes) |

Description

A “Speed Signal” code indicates a faulty speed sensor signal. In general, the system is configured to accept speed signals from any one of several sources (analog, digital, J1708/1587 or J1939). In this standard configuration, a loss of speed signal fault is indicated by code 18. In some specific instances, a vehicle may be configured to only accept speed from a specific data link. In these cases, codes 76 (SAE J1708/1587) and code 77 (SAE J1939) may be used to indicate a speed signal fault.

- Wiring; sensor connection
- Digital signal is missing
- Adjustment; gap not correct
- A missing data link speed signal (1587 or J1939)

Note: These codes will occur if Electronic Control Unit (ECU) power has been cycled 50 times and no speed signal is received. Fifty power cycles can occur after 25 engine starts without moving the vehicle. However, the code will clear as soon as a speed signal is received.

To correctly diagnose faulty components, connect the Diagnostic Tool (see “Diagnostics” on page 13 for test equipment and descriptions) and follow the procedure in “(Code 18, 76, 77) - Speed Signal” on page 54.

See “Troubleshooting Tips” on page 22 for assistance on diagnosing issues.

Speed Sensor
Harness Connector

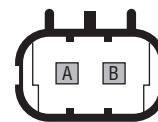

ECU Harness Connector

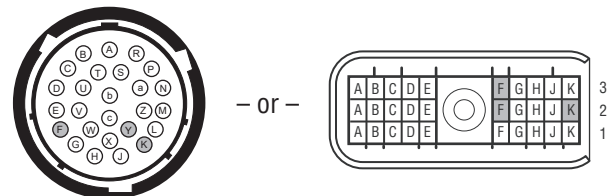

Service Codes

(Code 18, 76, 77) - Speed Signal

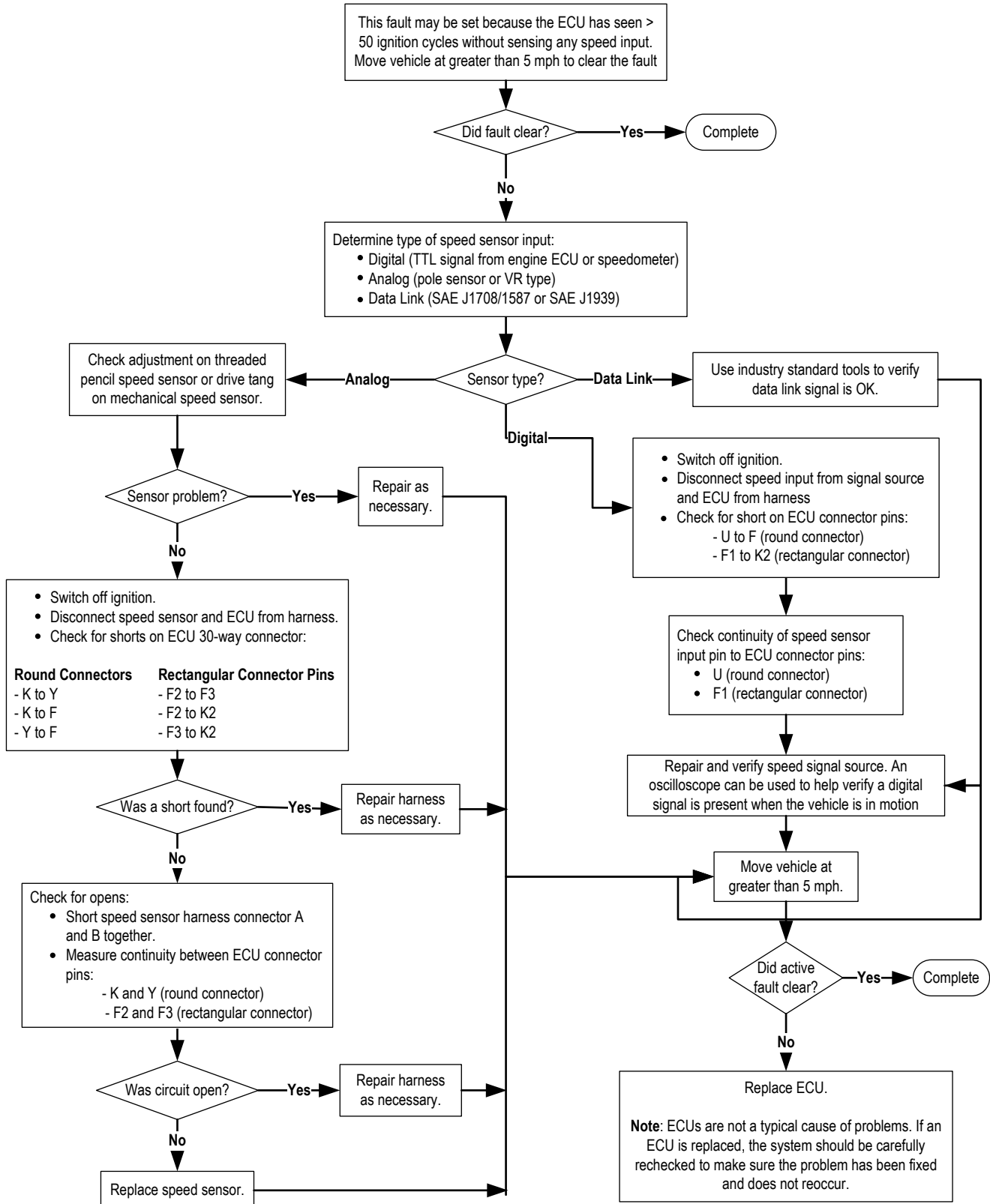

Service Codes

(Codes 47, 48) - 5 Flashing Lights or DDM – Dashes “- -”

Type: Supply Tank Sensor

| SYSTEM MODE | CONDITION | POSSIBLE CAUSES (LISTED IN ORDER OF LIKELY OCCURRENCE) |
|---------------------|--------------------------------------------------------------------------|------------------------------------------------------------------------------------------------------------------------------------------------------------------------------------------------------------------------------------------------------------------------------------------------------------|
| Pressure Check Only | No tank sensor reading (Null) | <ul style="list-style-type: none">• Sensor wire is broken or (disconnected)• Signal wire is shorted to ground• Faulty sensor |
| Pressure Check Only | Supply tank transducer failed comparison to PCU sensor reading (Erratic) | <ul style="list-style-type: none">• Tank sensor wires damaged or shorted• Poor tank sensor connections• Faulty or contaminated tank sensor• PCU sensor wires damaged or shorted• Poor PCU sensor connections• Faulty or contaminated PCU sensor |

Description

Supply Tank Sensor, Fault (47): If the supply tank sensor reading is “zero absolute” a Null fault will be logged, Supply Tank Sensor, Fault (48): During a pressure check when the tank sensor reading is compared to the PCU sensor reading and the two do not match within a specified tolerance, the “Erratic” fault will be logged. The DDT tool can help to measure the two readings to determine which sensor is inaccurate.

The components that can cause this code to be set include:

- **Wiring:** open, damaged or shorted
- **Sensor:** contaminated or faulty
- **PCU:** faulty sensor (See faults 34, 47), contaminated
- **ECU:** faulty (not likely)

To correctly diagnose faulty components, connect the Diagnostic Tool (see “[Diagnostics](#)” on page 13 for test equipment and descriptions) and follow the procedure in “[\(Codes 47, 48\) - Supply Tank Sensor](#)” on page 56.

See “[Troubleshooting Tips](#)” on page 22 for assistance on diagnosing issues.

Service Codes

(Codes 47, 48) - Supply Tank Sensor

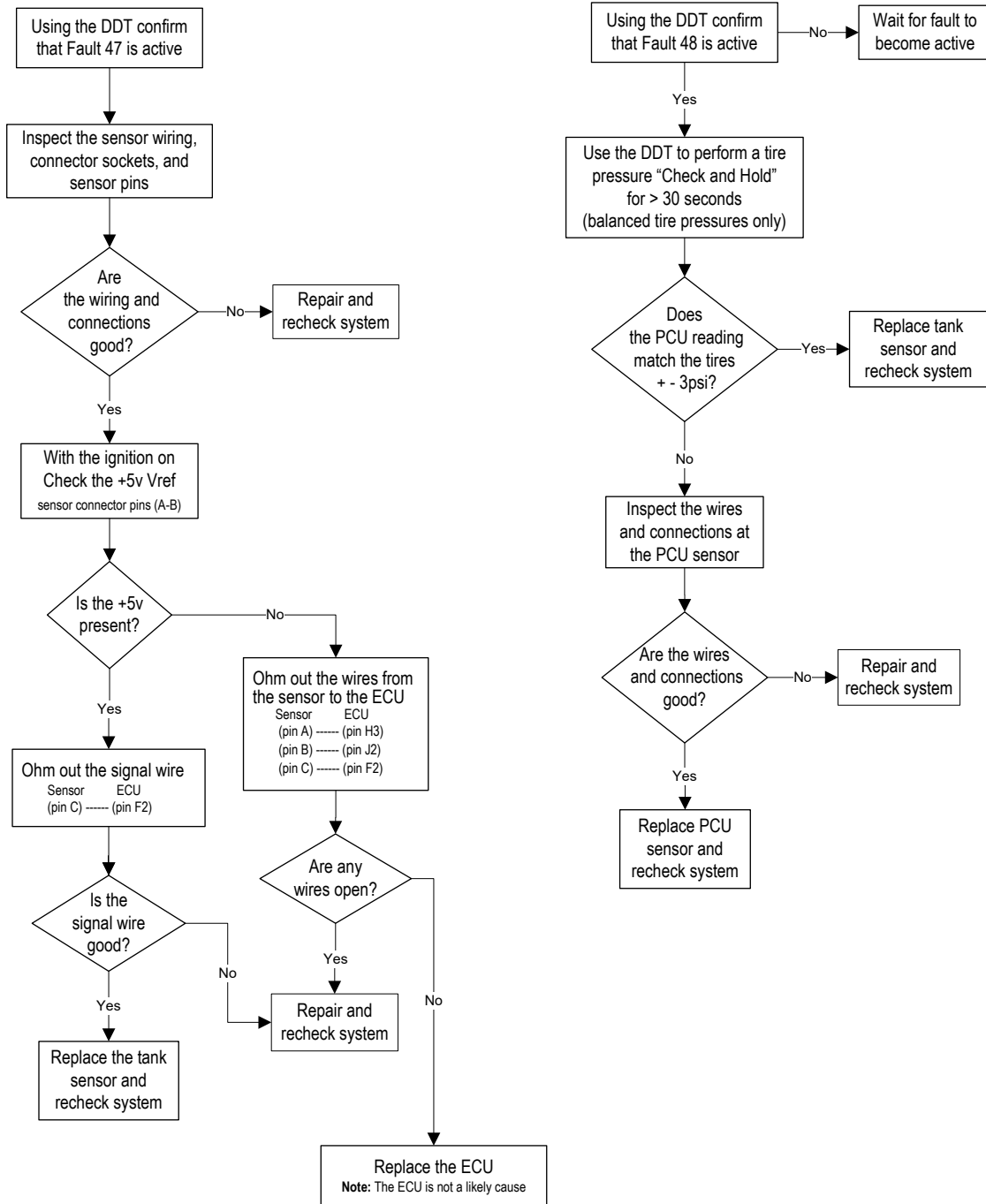

Service Codes

(Codes 53, 57, 58, 67, 68) - No Indication or DDM – Dashes “- -” (Implementation Specific)

Type: Miscellaneous Output (Spare1, Spare2, Spare3, Spare4, Warn lamp, Buzzer)

| SYSTEM MODE | CONDITION | POSSIBLE CAUSES (LISTED IN ORDER OF LIKELY OCCURRENCE) |
|------------------|--------------------------------------------------------|----------------------------------------------------------------------------------------------------------------------------------------------------------------------------------------------------------------------------------------------------------|
| Normal Operation | Miscellaneous output failed electrical diagnostic test | <ul style="list-style-type: none"> • Spare output wire open or broken • Spare output wire shorted to ground • Spare output wire shorted to power • Faulty vehicle component • Faulty ECU (not likely) |

Description

A “Miscellaneous Output Fault” code indicates an electrical fault in an OEM specific spare output device (i.e. differential locks, transmission relay, warnings, etc.). System operation is not affected when these faults are detected.

! WARNING: Vehicle drivability may be severely impaired.

Components that can cause this code to be set include:

- **Wiring:** open, broken or shorted
- **Vehicle device:** relay, solenoid, indicator, etc.
- **ECU:** faulty (not likely)

The troubleshooting tree first tests that the associated ECU harness pin is not shorted to ground and is continuous to the component. If continuity exists, the component must be repaired or replaced.

To correctly diagnose faulty components, connect the Diagnostic Tool (see “Diagnostics” on page 13 for test equipment and descriptions) and follow the procedure in “(Codes 53, 57, 58, 67, 68) - Miscellaneous Output” on page 58.

See “Troubleshooting Tips” on page 22 for assistance on diagnosing issues.

ECU Harness Connector

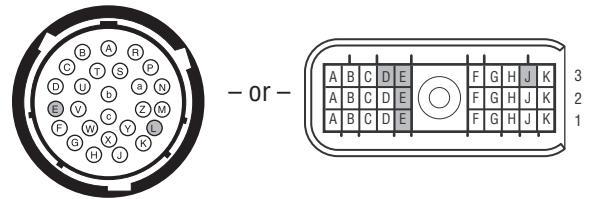

Service Codes

(Codes 53, 57, 58, 67, 68) - Miscellaneous Output

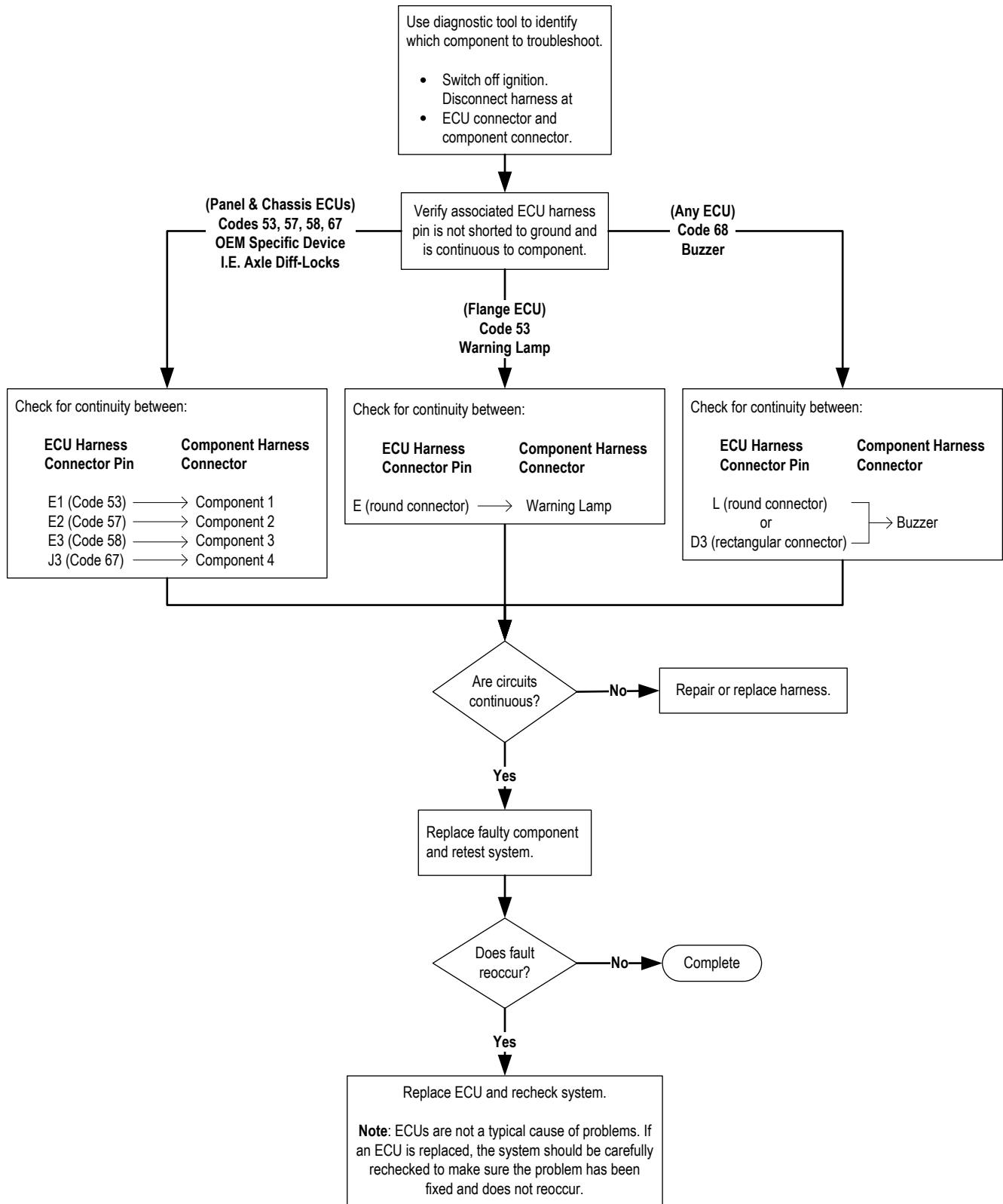

Service Codes

(Codes 61, 62) - No Indication

Type: Wheel Valves (Sluggish Shutoff)

| SYSTEM MODE | CONDITION | POSSIBLE CAUSES (LISTED IN ORDER OF LIKELY OCCURRENCE) |
|------------------|---------------------------------------------|--------------------------------------------------------------------------------------------------------------------------------------------------------------------|
| Normal Operation | Slight loss of tire pressure after shut off | <ul style="list-style-type: none">• Old or contaminated wheel valves• Extreme cold operating temperatures• Air passage restriction |

Tire Pressure Check

The Central Tire Inflation System is not continuously pressurized; pressure checks occur on a periodic basis. During tire pressure checks, the system delivers compressed air to each channel for approximately two seconds while monitoring the pressure in that channel.

Note: If the pressure loss is due to air dumping out QRV's, there are no tire or line leaks, and it is extremely cold, the condition may be temporarily corrected by venting the wheel valve cover screws (loosen screw and re-tighten). Make sure the CTIS is not functioning when venting screws.

To correctly diagnose faulty components, follow the procedure in [“\(Codes 61, 62, 64, 65\) - Wheel Valve Shut Off” on page 61](#).

See [“Troubleshooting Tips” on page 22](#) for assistance on diagnosing issues.

Description

Codes - **61** (Single Channel PCU), **61** (Two Channel PCU Front), **62** (Two Channel PCU Rear) If the system has determined the tires are losing air during the 30 second confirmation check the following criteria applies:

1. If the tire pressure loss is **Minor**:

- 1.1.** The system will re-inflate the tires to confirm 6 times
- 1.2.** After the 6 inflations the system will not inflate again but wait for another 30 seconds
- 1.3.** After the 30 seconds if the tire pressures did not continue to drop, the system will log a “Sluggish Shut Off” fault and normal operation will continue
- 1.4.** If after the 30 seconds the tire pressure continues to drop, the system will then log the [“Codes 41, 42”](#) “Tire Leak” (Confirm) fault.

Causes for code include:

- Wheel valves: old or contaminated
- Extremely cold ambient temperature
- Lower control line: restricted or kinked
- QRV: restricted vent

Service Codes

(Codes 64, 65) - No Indication

Also see [“\(Codes 41, 42\) - 4 Flashing Lights or “CHECK TIRES” Flashing”](#) on page 39.

Type: Tires loosing air after shut off

| SYSTEM MODE | CONDITION | POSSIBLE CAUSES (LISTED IN ORDER OF LIKELY OCCURRENCE) |
|------------------|------------------------------------------------|------------------------------------------------------------------------------------------------------------------------------------------------------------------------------------------------------------|
| Normal Operation | Sustained loss of tire pressure after shut off | <ul style="list-style-type: none">• Damaged and leaking tire(s) or tire hose• Extreme cold temperatures• Old or contaminated wheel valve• Air passage restriction |

Tire Pressure Check

The Central Tire Inflation System is not continuously pressurized; pressure checks occur on a periodic basis. During tire pressure checks, the system delivers compressed air to each channel for approximately two seconds while monitoring the pressure in that channel until stable.

If the system is allowed to operate for a long enough period, faults (41, 42) Confirmation Check Failure should eventually become active.

To correctly diagnose faulty components, connect the Diagnostic Tool (see [“Diagnostics”](#) on page 13 for test equipment and descriptions) and follow the procedure in [“\(Codes 61, 62, 64, 65\) - Wheel Valve Shut Off”](#) on page 61.

See [“Troubleshooting Tips”](#) on page 22 for assistance on diagnosing issues.

Note: If the pressure loss is due to air dumping out QRV's, there are no tire or line leaks, and it is extremely cold, the condition may be temporarily corrected by venting the wheel valve cover screws (loosen screw and re-tighten). Make sure the CTIS is not functioning when venting screws.

Description

Codes - **64** (Single Channel PCU), **64** (Two Channel PCU Front), **65** (Two Channel PCU Rear) If the system has determined the tires are losing air during the 30 second confirmation check the following criteria applies:

1. If the tire pressure loss is **Substantial**:
 - 1.1. The system will re-inflate the tires to confirm 6 times
 - 1.2. The system will then log the “Shut Off” (Historical) fault and log a [“Codes 41, 42”](#) Active “Tire Leak” (Confirm) fault
 - 1.3. The system will then turn on 4 Flashing LEDs or “Check Tires”, and send the Fault Code message on the CAN bus
 - 1.4. The system will continue to re-inflate as long as it can keep up with the pressure loss

 **IMPORTANT:** Upon a warning indication the vehicle operator is responsible for determining the cause for the pressure loss. Continuous re-inflation can over inflate non-affected tires.

Causes for this code include:

- Tires(s): damaged and leaking
- Tire hose: damaged and leaking
- Extremely cold ambient temperature
- Wheel valve: old or contaminated
- Lower control line: restriction, kinked
- QRV: restricted vent

Service Codes

(Codes 61, 62, 64, 65) - Wheel Valve Shut Off

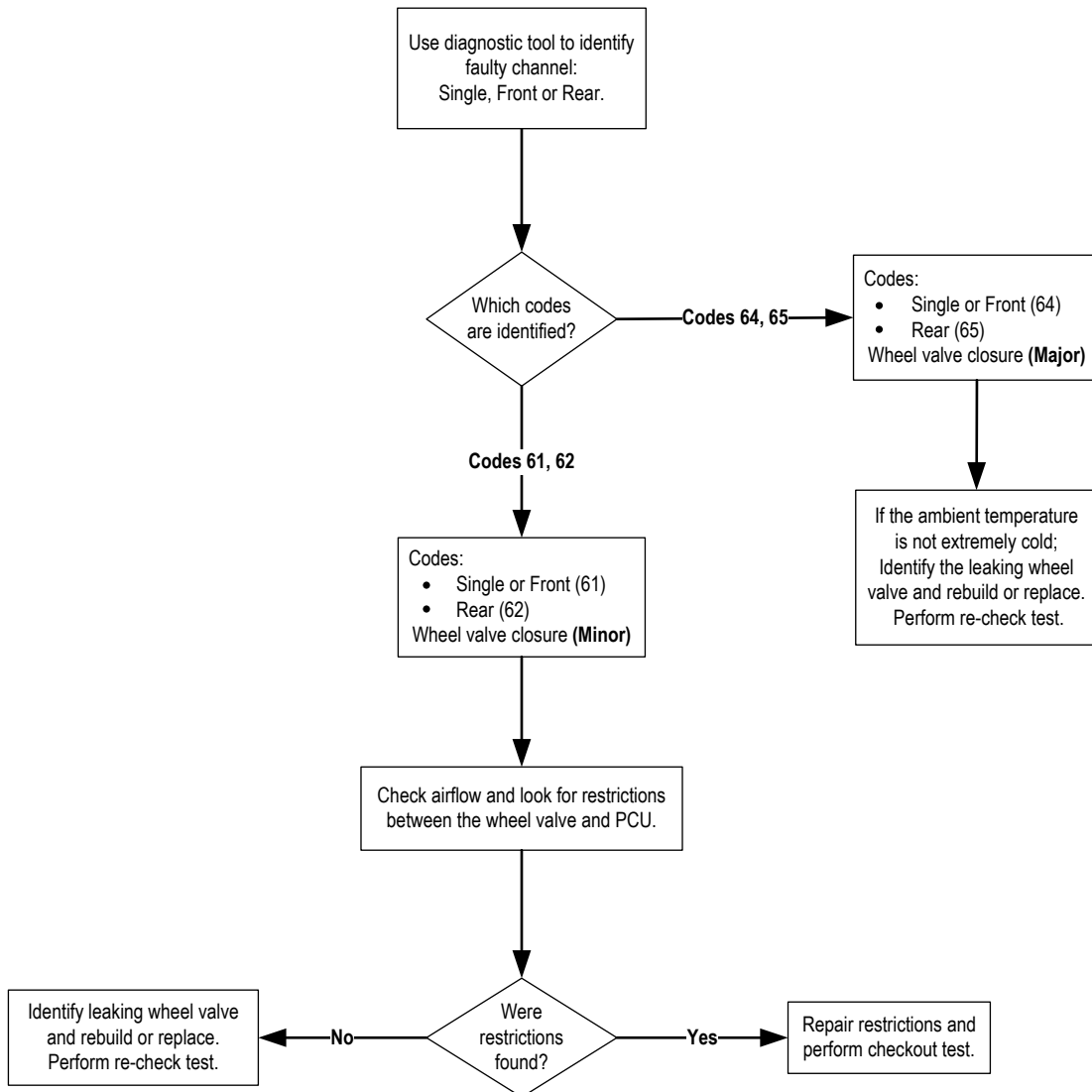

Service Guidelines

General Information

CTIS Service

The Central Tire Inflation System requires normal maintenance much the same as other systems on the vehicle. Following are some general rules that apply to Central Tire Inflation service:

Clean and Dry Air Supply

The Dana Central Tire Inflation System requires a constant supply of clean, dry air. An adequately sized and properly maintained air dryer is critical for continued proper operation of the Central Tire Inflation System. Even though the air dryer may be working properly, moisture can accumulate in the supply tank during normal operation due to the increase in air consumption. It is important to drain the supply tank daily. Draining the supply tank completely (releasing all air pressure) when the truck is not in use will also help keep moisture under control.

Line Replacement and Routing

When replacing air lines, do not allow kinks, sharp bends or stretching in order to tighten joints. If any tube or hose segment does not appear to fit easily, it could mean you are not using the proper part or that you are not following service procedures properly. Ensure that replacement lines are the correct length and size. Be cautious of any contaminants (rubber flash, plastic particles, etc.) getting in the lines when replacing them.

Each segment of the pneumatic system must be secured to the vehicle frame or other installed line. After completing assembly of each segment, use cable ties to anchor the segment at approximately 18" intervals.

 **CAUTION:** Proper Central Tire Inflation System operation requires correct air line diameters and lengths. Incorrect air line replacement can affect both performance and operation of the system.

Joint Compounds and Fittings

Here are some important “Do’s” and “Don’ts” regarding the use of thread sealant:

- **Do** apply a thin coating of compound on male threads of pipe joints, tubing connections, and other system fittings.
- **Don’t** use Teflon thread tape anywhere in the air system (Teflon tape shreds can become lodged in valving).
- **Don’t** use any compound on O-ring, compression or flare fitting connections. Instead, apply a thin coat of silicone grease to O-rings and flares.
- **Do** follow manufacturer recommended guidelines when tightening fittings.

Service Guidelines

Air Filter Change

The illustration below shows the location of the air filter in each wheel valve. Air filters should not be cleaned or reused. This filter must be replaced with a new filter whenever the tire or wheel valve is serviced. Use the illustration as reference in completing the air filter replacement as follows:

1. Working quickly to prevent air loss, remove the tire hose assembly from the fitting on the tire port (nearest the tire fill valve) of the wheel valve. Cap hose to prevent air loss.
2. Use a flat blade screwdriver to dislodge (unscrew counterclockwise) the air filter from the wheel valve. Discard the used air filter.
3. Install new air filter by pressing it straight into wheel valve tire port (oriented as shown below).
4. Remove cap, install tire hose assembly to wheel valve outlet port, and torque to 16-19 lb. ft.

Wheel Valve with Tire Hose

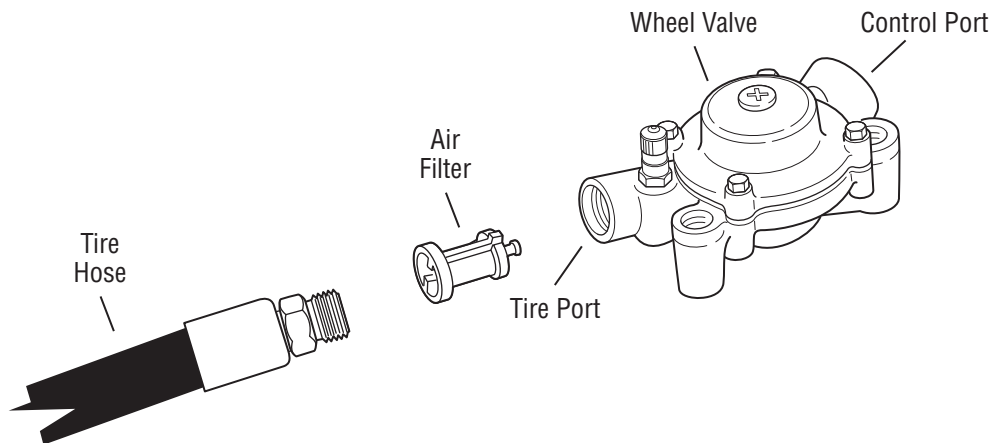

Integrated Wheel Valve

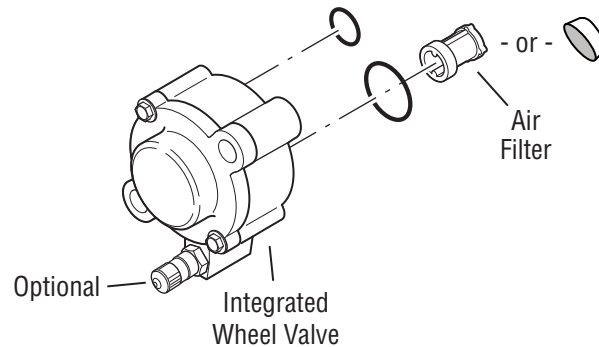





Integrated Wheel Valve

1. Remove all air from tire.
2. Remove valve from wheel (watch for o-rings under the base).
3. Remove air filter from the wheel or the valve base and discard. Install the new air filter just as it was removed
4. Ensure both o-rings are installed on the base of the valve and reinstall to wheel.
5. Re-inflate tire.

Wire Harness

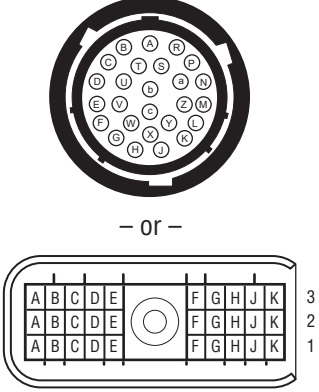
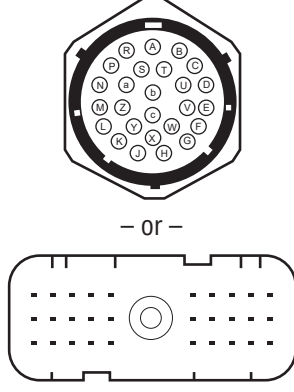
Connector Illustrations

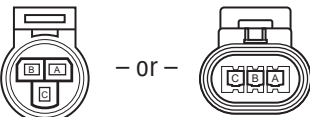
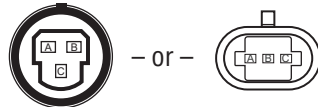
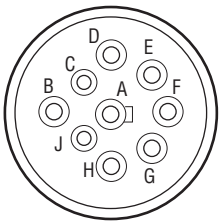
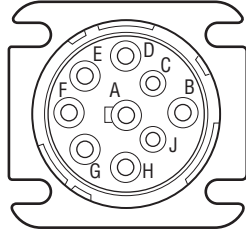
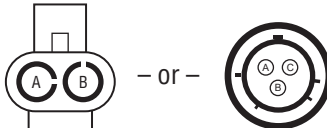
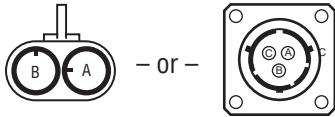
Note: All views are looking into the connector.

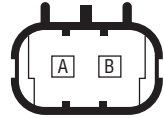
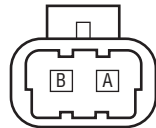
| | Harness Connectors | Component Connectors |
|-----------------------|-------------------------------------------------------------------------------------|--------------------------------------------------------------------------------------|
| ECU |  |  |
| PCU |  |  |
| Pressure Sensor |  |  |
| Diagnostics |  |  |
| Pressure Switch |  |  |
| Pressure Sensor |  |  |
| Speed Sensor (Option) |  |  |

Wire Harness

M-9XX Wiring Diagram

*Note: 676422 and 676603 (Optional Harness)

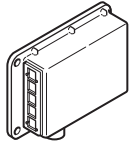
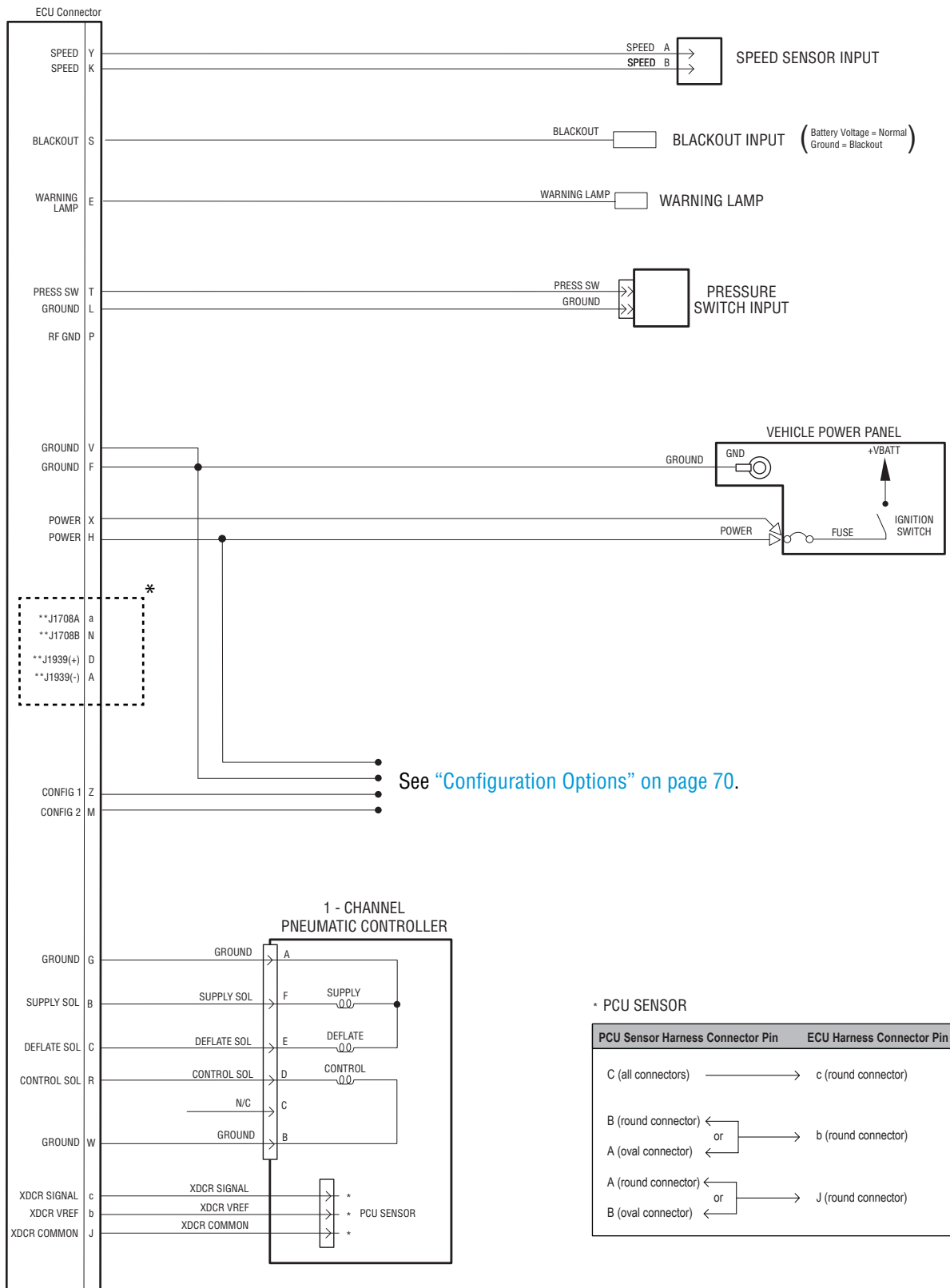

PCU SENSOR

| PCU Sensor Harness Connector Pin | ECU Harness Connector Pin |
|----------------------------------|---------------------------|
| C (all connectors) | c (round connector) |
| B (round connector) | b (round connector) |
| A (oval connector) | |
| A (round connector) | J (round connector) |
| B (oval connector) | |

Wire Harness

Flange Mount Wiring Diagram

Note: 1 - CHANNEL is standard, 2 - CHANNEL is optional.

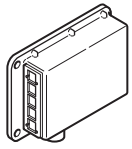
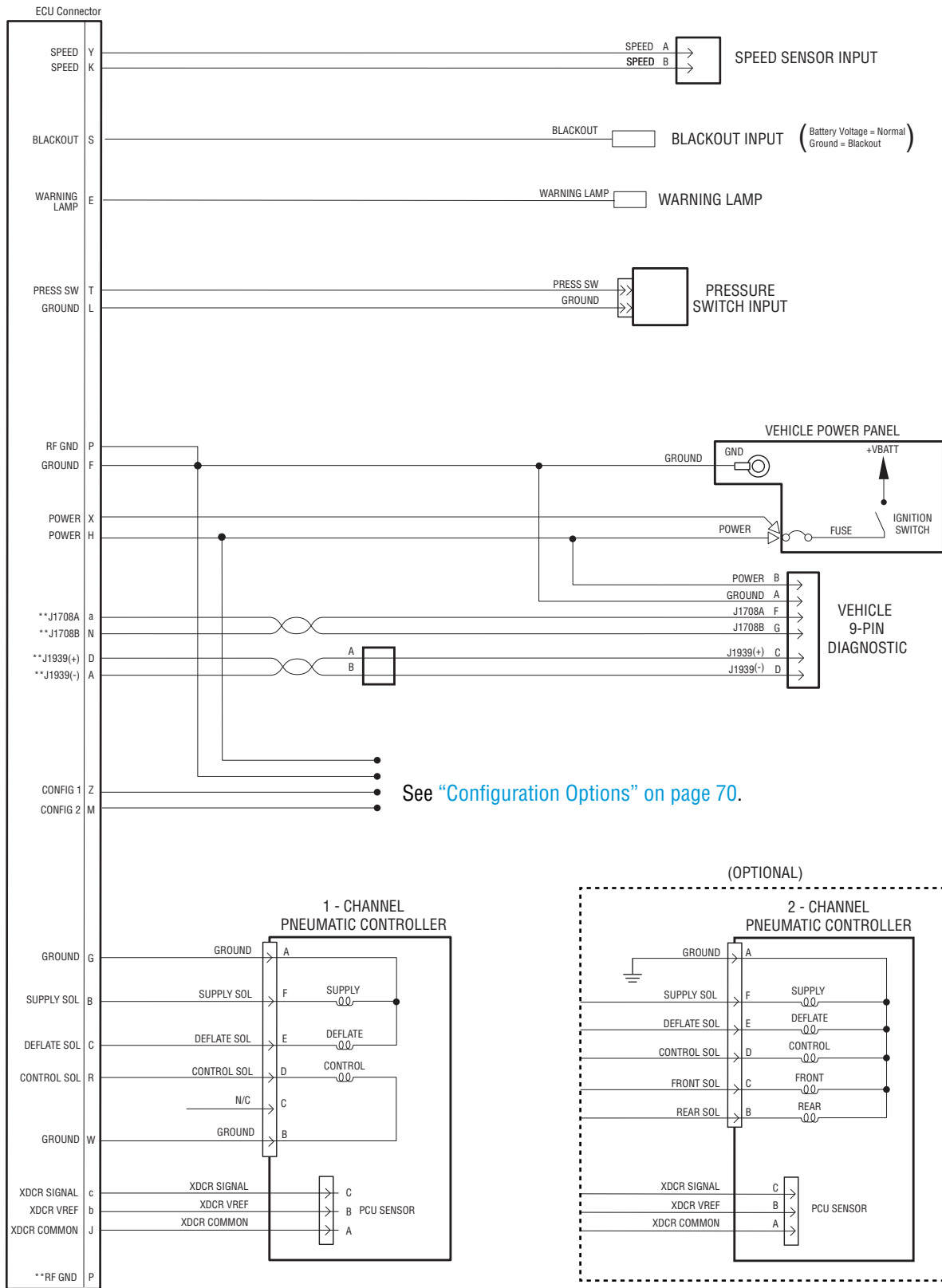

** MAY EXIST ON SOME SYSTEMS AND NOT ON OTHERS

Wire Harness

Panel Mount Wiring Diagram

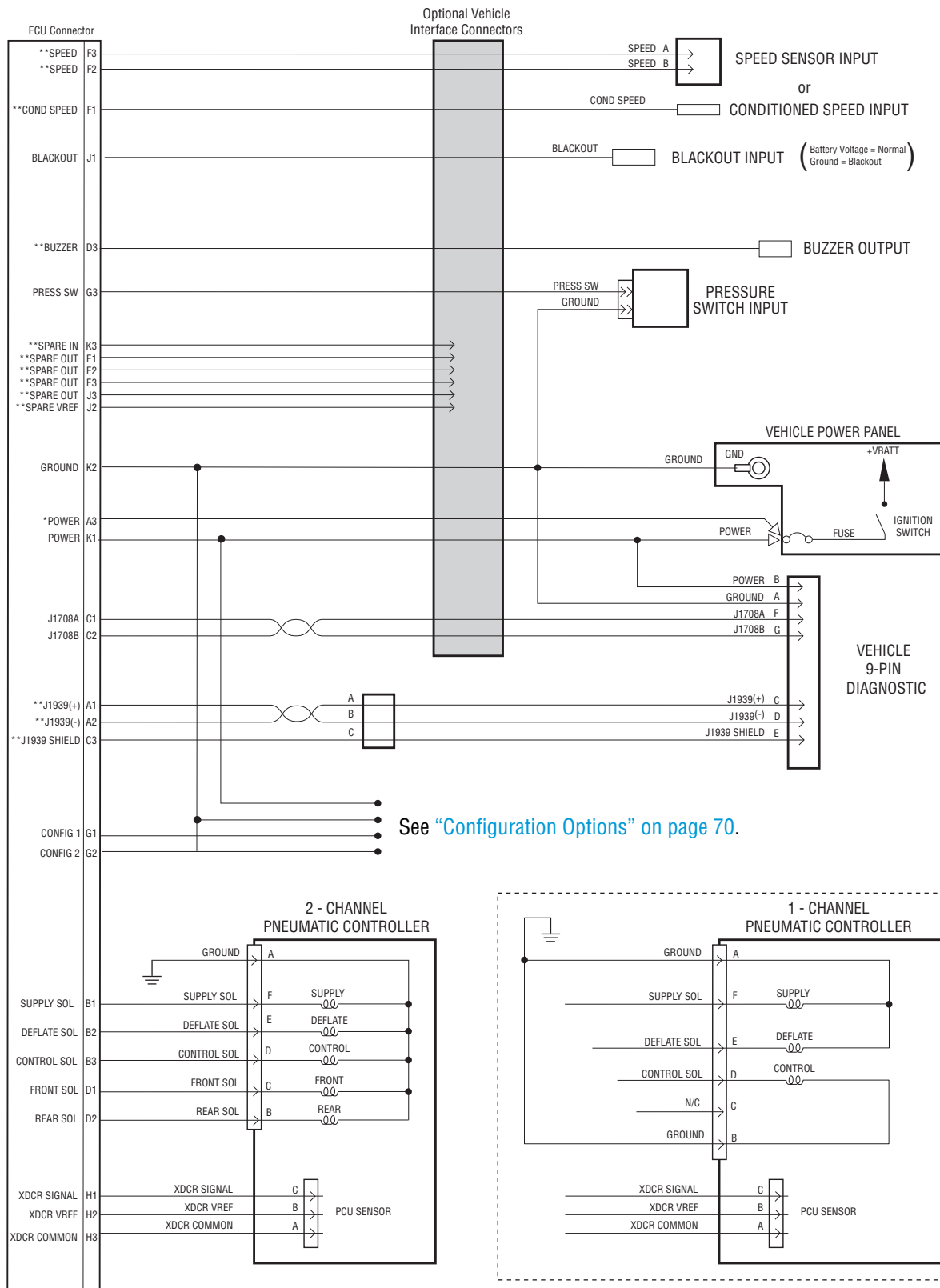

* 12V SYSTEMS ONLY

** MAY EXIST ON SOME SYSTEMS AND NOT ON OTHERS

Wire Harness

Chassis ECU with DDM Wiring Diagram

Note: All Power Switched

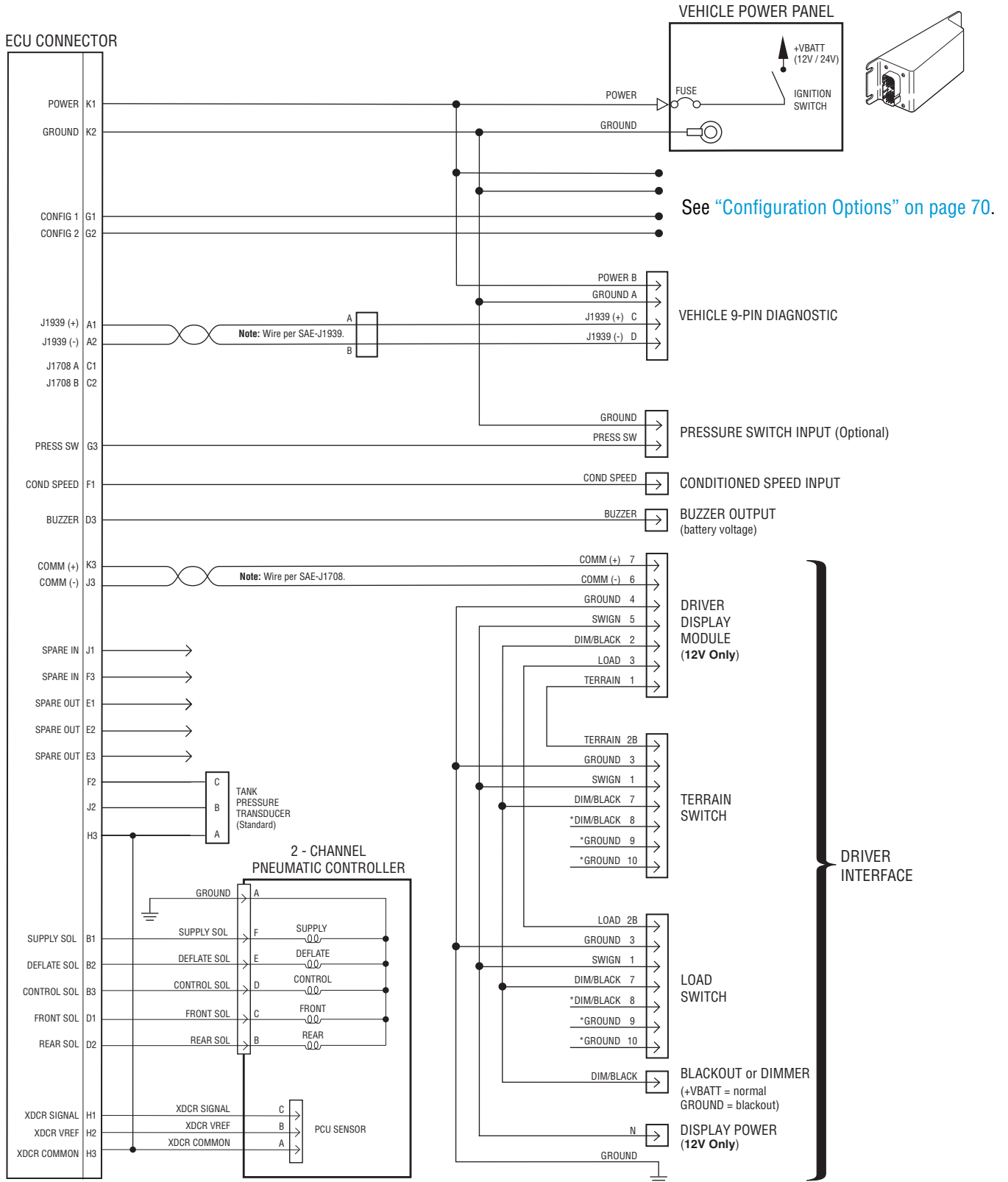

Note: Optional 1-Channel PCU (See [page 67](#)).

*Connections to pins 8, 9, and 10 are made internally. Earlier versions of the switches required these connections to be made in the harness.

Wire Harness

Configuration Options

The CTIS ECU has two inputs that can be wired one of three ways (High Volt, Ground or Open). This allows one ECU to be used on 9 different variables of vehicle. Differences can include such parameters as tire and load pressures, wheel base length, and number of axles. These settings are predetermined by Dana and set by the OEM. The connections to the ECU inputs are typically hard wired internally to the electrical harness. The DDT tool will display this selection and allow Dana service to better assist in troubleshooting issues.

Note: The ECU connection letters in this table are different from the actual connections in the diagrams.

| <u>ECU In</u> | <u>Harness</u> |
|---------------|----------------|
| Config 1 (A) | Power (C) |
| Config 2 (B) | Ground (D) |

Config 0

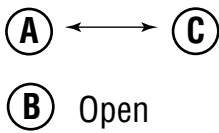

Config 1

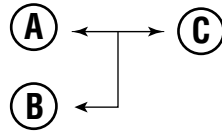

Config 2

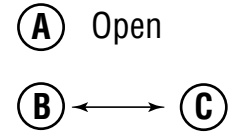

Config 3

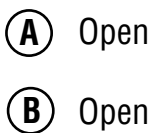

Config 4

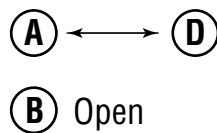

Config 5

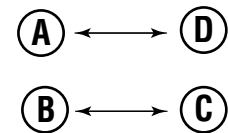

Config 6

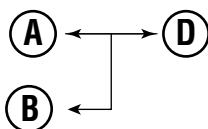

Config 7

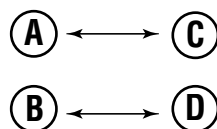

Config 8

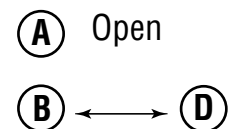

For spec'ing or service assistance, call 1-877-777-5360 or visit our website at www.dana.com/cv

Dana Commercial Vehicle Products Group

3939 Technology Drive
Maumee, Ohio, USA 43537

www.dana.com/cv



SPICER®

Drivetrain Products

Application Policy

Capacity ratings, features, and specifications vary depending upon the model and type of service. Application approvals must be obtained from Dana; contact your representative for application approval. We reserve the right to change or modify our product specifications, configurations or dimensions at any time without notice.

Printed in USA AXTS-0015 03/17