



FRONT AND REAR LIGHT AXLE PARTS, KITS AND APPLICATIONS

Chrysler/Dodge, Ford,
General Motors/Chevrolet and Jeep
Model Years 1978-1998



X510-9
June 2004

Supersedes Year
Ranges in the following
catalogs:

X510-2 dated 1/2002
X510-3 dated 1/2003
X510-5 dated 9/2001
X510-6 dated 6/2000

Corrections from original:

Date	Page	Description of Change
4/2/09	157	Removed "contact vehicle mfg." note from item# 8 - Oil Seal
9/2/14	103	Changed p/l and t/l disc & plate kit part numbers





WARNING - Failure to follow these instructions could affect vehicle performance and/or safety and result in personal injury or death.

- **Do not convert or alter Spicer axles except in accordance with vehicle manufacturer's instructions.**

Spicer axles are designed to meet OEM vehicle manufacturer's design and performance specifications. Improper conversion or alteration of these axles can damage the axles and/or other vehicle systems. Contact the OEM manufacturer for specific directions and guidelines.

- **Do not change axle gear ratios on vehicles with anti-lock braking systems except in accordance with the vehicle manufacturer's instructions.**

Vehicles with anti-lock braking systems may utilize sensors and tone rings within the axle housings to ensure the functioning of the anti-lock brakes. Improperly changing the axle ratios may defeat the anti-lock braking system. If changing axle ratios will require changing the location of the tone ring on the ring gear flange relative to the location of the sensor in the axle housing, contact the OEM manufacturer for specific directions and guidelines.

- **Do not reuse or substitute ring gear bolts.**

If you reuse a ring gear bolt or substitute an inferior quality bolt, the bolt may loosen or back out of its threaded hole, causing severe damage to the axle gears and other components and possibly resulting in a sudden "locking up" of the axle and loss of control of the vehicle. Always use new bolts specifically recommended for the application and install bolts using proper tools and torquing to the proper specifications.



CAUTION - Do not substitute parts not of Spicer quality.

Spicer axles are designed for each model vehicle, and manufactured and tested for safety and best performance. Replacement parts from other manufacturers may not be made to Spicer's rigid quality standards. To be sure you're getting Spicer quality, always use genuine Spicer parts.



This symbol warns of possible personal injury.

How to Use This Catalog	ii
General Information	iv
Axle Kits	vi
Bill of Material Listing	BM-1 thru BM-18

Chrysler / Dodge

Model 35 /194 IFS Front 1997-1999	1-3
Model 44 /216 Front 1979-1989	5-8
Model 44 /216 Disconnect Front 1985-1993 1/2 Except Ram	9-13
Model 44 /216 Disconnect Front 1994-1998 1/2 Ram	15-20
Model 60 /248 Front 1979-1993	21-26
Model 60 /248 Disconnect Front 1994-1998 1/2	27-35
Model 61 Front 1987-1993 1/2	37-40
Model 44 /216 ICA Rear 1993 1/2-1998	41-44
Model 60 /248 Rear 1979-1998 1/2 Except Ram	45-51
Model 60 /248 Rear 1994-1998 1/2 Ram	53-57
Model 70 /267 Rear 1979-1993 1/2 Except Ram	58-68
Model 70 /267 Rear 1994-1998 Ram	69-74
Model 80 /286 Rear 1994-1998 1/2	75-82

Ford

Model 28 /174 IFS Front 1983-1997	83-88
Model 35 /194 IFS Front with Cardan Joints 1990-1997 1/2	89-94
Model 44 /216 IFS Front 1980-1996 1/2	95-110
Model 50 /229 IFS Front 1980-1998	111-116
Model 28 /174 Front 1990-1997	117-119
Model 35 /194 Front with CV Joints 1995-1998 1/2	121-124
Model 44 /216 Front 1979	125-128
Model 50 /229 Front 1998 1/2	129-131
Model 60 /248 Front 1978-1998	133-139
Model 30 /194 Rear 1986-1989 1/2 Aerostar	141-143
Model 44 /216 Rear 1979	145-147
Model 60 /248 Rear 1978-1998 1/2	149-163
Model 61 Rear 1979-1987	165-171
Model 70 /267 Rear 1979-1998	173-197
Model 80 /286 Rear 1992-1998 1/2	199-205
Optional Camber/Casting Bushing Chart	206
Differential Bearing Adjusting Shims	207

GMC / Chevrolet

Model 44 /216 Front 1978-1980	209-212
Model 60 /248 Front 1979-1991 1/2	213-217
Model 36 /200 ICA Rear 1984-1996 1/2 Corvette	219-222
Model 44 /216 ICA Rear 1980-1990 1/2 Corvette	223-226
Model 44 /216 Rear 1984-1994 F-Car	227-230
Model 60 /248 Rear 1979-1991 1/2 G-Van	231-234
Model 70 /267 Rear 1979-1997	235-245
Model 80 /286 Rear 1992-1998 1/2	247-253

Jeep / Eagle

Model 30 /181 Front 1978-1998 1/2	255-281
Model 30 /181 Disconnect Front 1984-1996	283-289
Model 30 /181 IFS Front 1980-1987 1/2 Eagle	291-294
Model 30 /181 w/ Collapsible Spacer 1992 1/2-1998 1/2	295-302
Model 44 /216 Front 1978-1992	303-308
Model 44 /216 Disconnect Front 1982-1984	309-312
Model 35 /194 Rear 1985 1/2 -1998 1/2	313-329
Model 44 /216 Rear 1977-1998	331-337
Model 44 /216 Rear 1978-1998 Grand Cherokee	339-342
Model 60 /248 Rear 1977-1988	343-347
Model 70 /267 Rear 1985	349-351

How to Use This Catalog

This catalog contains applications and part listings for front and rear axles which fit vehicles from model years 1978-1998. For information on model years between 1967-1978, please refer to catalog X510-8DSD. For miscellaneous models from years 1979-1984, please refer to X510-7DSD.

The data in this publication is arranged by make, then in numerical order by model for front axles and then for rear axles. Each model contains the following three sections:

- Parts Listing and Exploded View**

This section contains an exploded view of the axle and lists all the part numbers for those parts illustrated. The parts that do not have a common part number have a footnote reference indicating where to find the correct part number for each Bill of Material.

X510-9

GM Model 44 /216 Front Axles Parts Listing



ITEM NO.	PART NUMBER	DESCRIPTION	ITEM NO.	PART NUMBER	DESCRIPTION
1	— ⁽¹⁾	Housing – Axle Service		706116X	KIT – Socket Assembly
2	— ⁽¹⁾	Drive Pinion & Gear Assembly			(inc 32,33,34,35,36,37,38)
3	30764	Slinger – Pinion Bearing Inner	32	44101	Nut – Hex Slotted
4	706031X	Inner Pinion Bearing Kit	33	500024-6	Pin – Cotter
	706376X	KIT – Diff & Pinion Adj Shim (inc 5, 7, 13, 16, 22)	34	35417	Ring – Adjusting Split
	706358X	KIT – Pinion Brg Adj Shim (inc 5, 7, 13, 16)	35	40112	Socket Assembly – Upper
			36	35566	Nut – Hex Jam
			37	40113	Socket Assembly – Lower

- Bill of Material Table**

This section contains vehicle applications listed in order by year. Included in the table are the major kits and assemblies for each Bill of Material number.



GM Model 44 /216 Front Axles Bill of Material Table

X510-9

Bill of Material	Axle		Ring Gear & Pinion Kit ⁽¹⁾	Axle Kits			Shaft & Joint Assy.	
	Diff. Type	Ratio		Case Assy. Kit ⁽¹⁾	Case Kit	Inner Parts Kit	Right Hand Shaft Assy.	Left Hand Shaft Assy.
1978-79 K-20								
610055-1	Standard	3.73	706017-4X	706020X	706024X	706027X	29833-1X	29833-2X
610055-2	Standard	3.73	706017-4X	706020X	706024X	706027X	29833-1X	29833-2X
610055-3	Standard	4.09	706017-5X	706021X	706025X	706027X	29833-1X	29833-2X
610055-4	Standard	4.09	706017-5X	706021X	706025X	706027X	29833-1X	29833-2X
1979 Blazer & K-10								
610054-1	Standard	2.72	706017-18Y	706020Y	706024Y	706027Y	29833-1Y	29833-2Y

- **Variable Parts Table**

This section contains the individual part numbers that vary by Bill of Material number for a given model.

X510-9

GM Model 44 /216 Front Axles Variable Parts Listing



Kits & Parts - Use With All Applications							
Description & Item Number (Refer to "Exploded View")			Bills of Material				
			610054	610055	610056	610079	610080
1	KIT – Right Knuckle Assy	-	700076	700076	700076	700141	700141
2	KIT – Left Knuckle Assy	-	700077	700077	700077	700142	700142
3	Bolt – Hex (qty 6)	39	36326-4	36326-4	36326-4	36326-2	36326-2

Note: Additional information on Spicer axles can be found in our General Information catalog number XGI. It contains the following sections:

- Bill of Material Numerical Listing
- Ring and Pinion Kits
- Differential Case Assembly Kits
- Axle Shaft Dimension and Components

General Information

How To Identify A Spicer Axle

All Spicer Carrier Type axles are identified with a manufacturing date (1) and Bill of Material number (2) stamped on the right or left hand tube on driving axles. The Bill of Material number may also be found on the carrier in some models as shown in illustration (2A). For independent front suspension (IFS) axles, the B/M number may be located at one of three locations: 1). A vertically positioned tag near the center of the right hand side support arm, 2) stamped into the left hand side support arm (opposite end of the camber adjuster), or 3) stamped into the "nose end" of the axle carrier. The location of the information will depend on the manufacturing date of the axle.

The axle model number will be cast into one of the webs as shown (3), or it can be on the nose.

Each axle contains a gear ratio tag (4), and if the axle is equipped with a limited slip differential, it will have a tag specifying the type of limited slip lubricant to be used (5).

Refer to the appropriate model number section for parts identification and a breakdown of the Bill of Material.

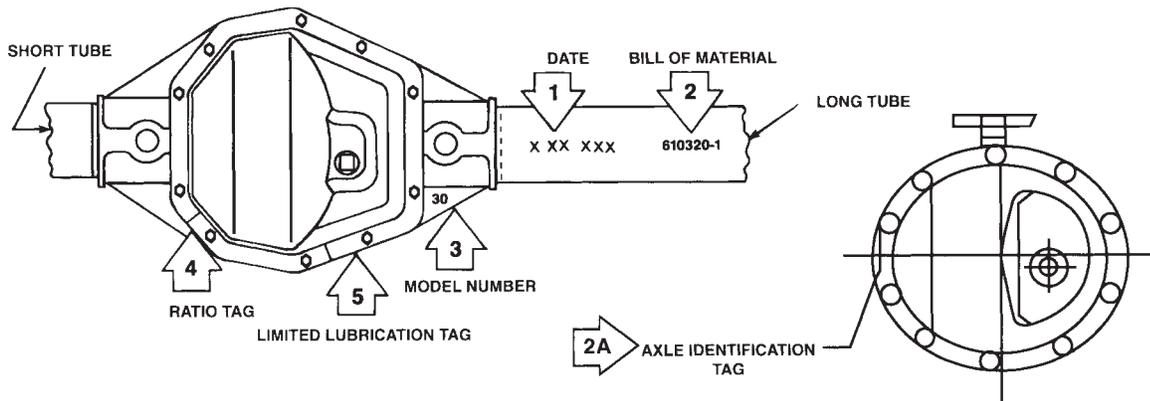

How To Change Gear Ratios

To increase or decrease a gear ratio, there are certain steps that must be taken. The differential case depends upon the ratio desired. For each axle model, there is a high-ratio and a low-ratio case as illustrated below:

Axle Model	Low Ratio Case	High Ratio Case	Axle Model	Low Ratio Case	High Ratio Case
Model 27	3.73 and Down	3.92 and Up	Model 50	4.10 and Down	—
Model 28	3.45 and Down	3.73 and Up	Model 60	4.10 and Down	4.56 and Up
Model 28 IFS Aerostar	2.27, 3.73	—	Model 61	Semi Float 3.00 and 3.07 only	
Model 30	3.55 and Down	3.73 and Up	Model 61	Full Float 3.31 and Down 3.54 and Up	
Model 35	2.35 only	—	Model 70	4.10 and Down	4.56 and Up
Model 35	2.73 - 3.31	3.54 and Up	Model 70-3HD	3.42 and Down	3.73 and Up
Model 36 ICA	2.73 and Down	3.07 and Up	Model 70-2UA	3.07 only	—
Model 44	3.73 and Down	3.92 and Up	Model 80	3.73 and Down	4.10 and Up
Model 44 ICA					
1984 & earlier	3.73 and Down	3.92 and Up			
Model 44 ICA					
1985 & later	2.87 and Down	3.07 and Up			

Example - If you have a model 44 Rear Axle with a 3.54 ratio and wish to change to a 3.73 ratio, you change only the ring gear and pinion assembly. If you change the ratio to a 4.09, you must change to a high-ratio case in addition to changing the ring gear and pinion. The application section will show you what case to use. When the vehicle is equipped with both front and rear driving axles, the gear ratios must be the same in both axles. The drive gear screws are self-locking and must be replaced with new screws each time that they are removed.

How Limited Slip Differentials Operate

A conventional differential transmits all the ring gear torque through the differential gears to the axle shafts. Torque is at all times equal on the axle shafts, and if one wheel slips, the other wheel can only put out as much torque as the slipping wheel.

The Spicer Limited Slip differential has the same power flow as a conventional differential, plus a more direct flow which automatically takes effect as driving conditions demand. This more direct power flow is from the differential case to each axle shaft through a clutch plate and disc arrangement.

Arrangement of these plates and discs is at the option of the vehicle manufacturer, so care should be taken during disassembly to note the arrangement of these components.

The Limited Slip construction permits differential action when required for turning corners and transmits equal torque to both wheels when driving straight ahead. However, when one wheel tries to spin due to leaving the ground, a patch of ice, etc., the clutch packs automatically provide more torque to the wheel which is not trying to spin.

The Limited Slip differential resists wheel spin on bumpy roads and provides more pulling power when one wheel tries to slip. In many cases of differences in traction, pulling power will be automatically provided until both wheels start to slip.

In diagnosis of vehicle operators' complaints, it is important to recognize two things.

1. If, with unequal traction, both wheels slip, the Limited Slip Differential has done all it can possibly do.
2. In extreme cases of differences in traction, the wheel with the least traction may spin after the Limited Slip has transferred as much torque as possible to the non-slipping wheel.

How To Distinguish a Powr-Lok™ from a Trac-Lok™

All Models **except Model 80 /286**: The Powr-Lok design is identified by its 2-piece case. The Trac-Lok design is identified by its 1-piece case.

Model 80 /286 only: Both the Powr-Lok and the Trac-Lok use 2-piece cases in the model 80 (286) axle. The difference between the two is in the shape of the holes for the cross shaft. The Powr-Lok case will have cross shaft holes that are "U" shaped in one case half and "V" shaped in the other case half. The Trac-Lok case will have cross shaft holes that are semicircles in both case halves.

It is also possible to replace an existing Powr-Lok unit with a complete Trac-Lok unit. For this purpose, the differential case assembly must be replaced.

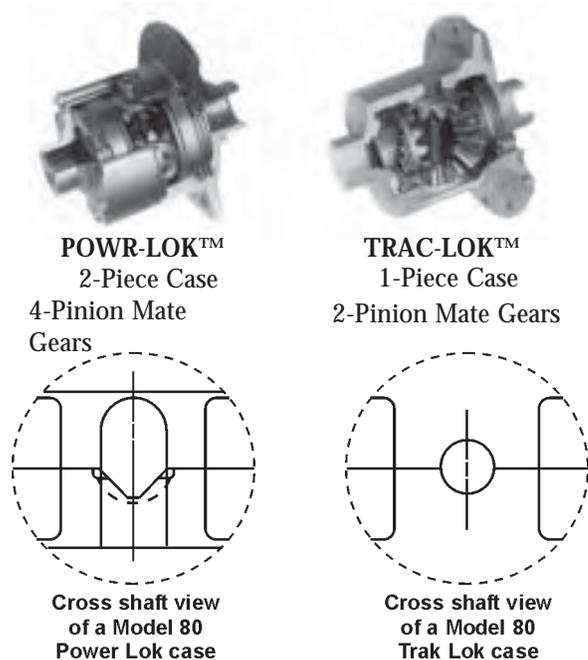

How To Obtain Special Service Tools

Special service tools (see service manuals) can be obtained from the following company:

Kent-Moore
 OE Tool and Equipment Group
 SPX Corporation
 28635 Mound Road
 Warren MI 48092-3499
 (800) 345-2233

Light Axle Kits



Bill of Material Numerical Listing

Bill of Material Number	Manufacturer	Model	Front / Rear	Application
603470	JEEP	60	Rear	1979 J20 Pickup
603643	CHRY	60	Front	1979-80 D-600
603647	CHRY	60	Rear	1979 D-200 & W-200 HD
603651	CHRY	70	Rear	1979 M-300 & M-400 Motor Home (2pc STD CASE)
603652	CHRY	70	Rear	1979 M-500 Motor Home
603653	CHRY	70	Rear	1979-83 P-300
603683	JEEP	44	Front	1978-79 Wagoneer / Cherokee
603685	JEEP	44	Front	1978-79 J10, J20, Honcho, Cherokee Wide Track
603695	CHRY	70	Rear	1979 D-300/400 & W-300/400
603696	CHRY	70	Rear	1979 D-300 Sweptline
603702	GM	60	Rear	1979 DRW G-Van 146" WB - Full Float
603703	GM	70	Rear	1979 G-300 146" WB - 70B
603704	GM	70	Rear	1979 C-30 Dual Wheel - 70HD
603725	FORD	60	Rear	1979 F-250 Crew Cab - Full Float
603732	JEEP	30	Front	1978 CJ5/CJ7 - External Type Wheel End
603815	JEEP	44	Rear	1977-79 Cherokee Chief (STD Transfer Case)
603816	JEEP	44	Rear	1977-79 Wagoneer & Cherokee (STD Transfer Case)
603817	JEEP	44	Rear	1977-79 Wagoneer & Cherokee (Quadra-Trac Transfer Case)
603818	JEEP	44	Rear	1977-79 Cherokee Chief Quadra-Trac
603820	JEEP	44	Rear	1977-80 Post Office Dispatcher
603831	CHRY	60	Rear	1979 Rail Maintenance
603841	CHRY	70	Rear	1979 WM 300
603884	GM	60	Rear	1979 DRW G-Van 125" WB - Full Float
603901	FORD	60	Rear	1979 F-250 4X4 - Full Float
603909	FORD	70	Rear	1980 Ambulance - 70HD
603916	CHRY	70	Rear	1979-84 CB-400 & MB-400
603917	CHRY	60	Rear	1979 D-200 & BD-600
603918	CHRY	70	Rear	1979-84 CB-300 HD & MB-400 HD
603919	CHRY	60	Rear	1979 MD-300 Dual Wheel HD
603920	CHRY	60	Rear	1979 B-300 Maxivan HD
603925	FORD	61	Rear	1979 F-250 4X2 - Full Float
603926	FORD	60	Rear	1979 F-250 4X2 - Full Float
603929	GM	70	Rear	1979 P-300 Motor Home - 70HD
603930	JEEP	60	Rear	1978-79 J20 Pickup
603932	FORD	61	Rear	1979-80 E-250 - Full Float
603934	FORD	70	Rear	1979-80 E-350 Van - 70B
603935	FORD	70	Rear	1979 F-350 Pick-Up - 70B
603936	FORD	70	Rear	1979-80 F-350 U-Haul - 70B
603937	FORD	70	Rear	1979 F-350 Chassis - 70B
603938	FORD	70	Rear	1979 E-350 Chassis - 70B
603940	FORD	70	Rear	1979-80 E-350 Chassis - 70HD
603941	JEEP	44	Rear	1979 J10 & Honcho Truck
603943	FORD	60	Rear	1980-81 F-250 3/4 Ton 4X2, 4X4 Pick-Up - Semi Float
603944	FORD	61	Rear	1980 F-350 4X2 Chassis - Full Float
603946	FORD	61	Rear	1980-81 F-250 4X2 - Semi Float
603947	FORD	61	Rear	1980 F-350 4X2, 4X4 Pick Up - Full Float
603949	FORD	70	Rear	1980 F-350 Big Dooley - 70HD
603955	CHRY	70	Rear	1979-83 WM-300
603962	FORD	70	Rear	1980 F-350 Chassis - 70B
603967	GM	44	Rear	1980 Corvette
603970	GM	70	Rear	1979 P-300 UPS - 70HD
603971	CHRY	60	Rear	1979-84 High Performance Racing Axle (semi-float)
603972	CHRY	60	Rear	1979-84 High Performance Racing Axle (semi-float)

Bill of Material Number	Manufacturer	Model	Front / Rear	Application
603973	FORD	44	Rear	1979 F-100 & F-150
603980	JEEP	60	Rear	1980-81 1/2 J20 Pickup
603987	GM	70	Rear	1979 P-300 UPS - 70HD
603989	CHRY	60	Rear	1980-88 1/2 D-200 W-200 & D-600
603990	CHRY	60	Rear	1980-84 C-300 & B-300 MB-300 HD
603992	CHRY	60	Rear	1980-82 D-200 & W-200 HD
603993	CHRY	60	Rear	1980-84 MB-300 Dual Wheel HD
603994	CHRY	60	Rear	1980-88 1/2 B-300 Maxivan HD
603995	CHRY	70	Rear	1980-84 D-300/400 & W-300/400
603997	CHRY	70	Rear	1980-83 M-300 & M-400 Motor Home (2pc STD CASE)
603998	CHRY	70	Rear	1980-83 M-500 Motor Home
605000	GM	60	Rear	1980-82 DRW G-Van 125" WB - Full Float
605001	GM	60	Rear	1980-82 DRW G-Van 146" WB - Full Float
605002	GM	70	Rear	1980-82 G-300 146" WB - 70B
605003	GM	70	Rear	1980-81 C-30 Dual Wheel - 70HD
605004	GM	70	Rear	1980-81 P-300 Motor Home - 70HD
605005	GM	70	Rear	1980-81 P-300 UPS - 70HD
605020	FORD	60	Rear	1980 1/2 E-250 - Full Float
605022	FORD	61	Rear	1981-83 E-350 DRW Chassis - Full Float
605030	FORD	61	Rear	1981 E-250 Van - Semi Float
605031	FORD	60	Rear	1981-81 1/2 E-250 Van - Semi Float
605038	FORD	70	Rear	1981-83 F-350 Chassis DSO Dual Wheel - 70B
605039	FORD	61	Rear	1981-83 F-350 Chassis - Full Float
605040	FORD	61	Rear	1981-83 F-350 - Full Float
605042	FORD	70	Rear	1981-82 E-350 Chassis - 70B
605043	GM	70	Rear	1985-89 P-300 UPS - 70HD
605044	FORD	70	Rear	1981-83 F-350 Heavy Duty Chassis - 70HD
605045	FORD	70	Rear	1981-83 F-350 Dual Wheel - 70HD
605053	FORD	70	Rear	1981-85 E-350 DSO - 70HD
605054	FORD	70	Rear	1981-83 F-350 U-Haul - 70B
605055	FORD	70	Rear	1981-82 F-350 DSO Ambulance - 70HD
605056	FORD	61	Rear	1981-83 E-350 School Bus - Full Float
605057	FORD	70	Rear	1981-82 E-350 School Bus - 70B
605062	GM	44	Rear	1981-83 Corvette
605064	FORD	61	Rear	1981 E-250 Van - Full Float
605068	GM	70	Rear	1980-81 P-300 Motor Home - 70HD
605079	JEEP	60	Rear	1982-85 J20 Pickup
605080	FORD	70	Rear	1981 1/2-83 E-350 DSO - 70B
605082	CHRY	60	Rear	1983-84 D-300 HD
605086	FORD	60	Rear	1982-83 F-250 - Semi Float
605087	FORD	61	Rear	1982 F-250 - Semi Float
605088	FORD	61	Rear	1982-83 E-250 Van - Semi Float
605089	FORD	60	Rear	1982-83 E-250 Van - Semi Float
605096	GM	70	Rear	1981 1/2 P-300 UPS - 70HD
605099	GM	70	Rear	1982-84 C/K-30 - 70HD
605101	FORD	70	Rear	1981 1/2-83 E-350 DSO - 70HD
605103	JEEP	44	Rear	1982-84 CJ10
605104	JEEP	60	Rear	1982 1/2-84 CJ10
605114	FORD	70	Rear	1982 1/2-83 E-350 DSO Chassis - 70U
605115	FORD	70	Rear	1983 E-350 DSO Chassis - 70U
605117	GM	70	Rear	1982 1/2-87 P-30 Motor Home/Disc Brakes - 70HD
605118	FORD	70	Rear	1982 1/2-83 F-350 DSO Wide Track - 70HD
605132	GM	60	Rear	1983 DRW G-Van 125" WB - Full Float

Bill of Material Numerical Listing

Bill of Material Number	Manufacturer	Model	Front / Rear	Application
605133	GM	60	Rear	1983 DRW G-Van 146" WB - Full Float
605134	GM	70	Rear	1983 G-300 146" WB - 70B
605138	FORD	70	Rear	1982 1/2-83 1/2 F-350 DSO Ambulance - 70HD
605139	FORD	70	Rear	1982 1/2-83 E-350 DSO - 70B
605143	FORD	70	Rear	1983 1/2 E-350 DSO - 70B
605145	FORD	60	Rear	1983 1/2 F-350 Pick-Up - Semi Float
605146	FORD	60	Rear	1983 1/2 F-350 Chassis - Semi Float
605154	FORD	61	Rear	1983 1/2 F-350 Pick-Up - Semi Float
605156	FORD	61	Rear	1983 1/2 F-350 Chassis - Semi Float
605158	CHRY	70	Rear	1985-90 1/2 Israel Aircraft
605169	FORD	60	Rear	1983 1/2-85 F-250 - Semi Float
605170	FORD	70	Rear	1984-85 F-350 6 Wheeler - 70HD
605172	GM	36	Rear	1984 Corvette
605175	FORD	70	Rear	1983 1/2 F-350 Chassis - 70U
605176	FORD	70	Rear	1983 1/2-85 F-350 Heavy Duty Chassis - 70HD
605178	FORD	61	Rear	1983 1/2 E-250 Van - Semi Float
605179	FORD	60	Rear	1983 1/2 E-250 Van - Semi Float
605180	GM	36	Rear	1984 Corvette
605192	CHRY	70	Rear	1984-85 D-300/D-450 Sweptline & D-350 & W-350
605196	JEEP	60	Rear	1985 AM 720
605197	FORD	61	Rear	1984-85 F-350 - Full Float
605198	FORD	61	Rear	1984-85 F-350 & F-350 Chassis
605200	GM	60	Rear	1985-86 DRW G-Van 125" WB - Full Float
605201	GM	60	Rear	1985-89 DRW G-Van 146" WB - Full Float
605202	GM	70	Rear	1984-89 DRW G-Van 146" WB - 70U
605203	GM	70	Rear	1984-86 C/K-30 & R/V-30 - 70HD
605204	FORD	70	Rear	1983 1/2-85 F-350 Pick-Up - 70U
605205	FORD	70	Rear	1983 1/2-85 F-350 Chassis - 70U
605206	FORD	70	Rear	1983 1/2 F-350 U-Haul - 70U
605207	FORD	70	Rear	1983 1/2-85 F-350 DSO Ambulance - 70HD
605208	FORD	70	Rear	1984-85 F-350 Chassis - 70U
605211	FORD	60	Rear	1984-85 E-250 Van - Semi Float
605212	FORD	61	Rear	1984-85 E-350 Van SRW - Full Float
605213	FORD	70	Rear	1984-85 E-350 Chassis - 70U
605214	CHRY	70	Rear	1985 D-300 & D-400 & D-700
605215	CHRY	70	Rear	1985 D-300
605218	GM	44	Rear	1984-85 F-Car
605220	GM	44	Rear	1985-87 Corvette
605222	CHRY	60	Rear	1985-88 1/2 B-300 (Van)
605224	CHRY	60	Rear	1985-85 1/2 D-200 & BD-600
605225	CHRY	60	Rear	1985-88 1/2 D-200 HD & D-300 HD
605235	CHRY	70	Rear	1985-88 1/2 Front Section Motor Home
605236	JEEP	44	Rear	1985 CJ10
605237	JEEP	60	Rear	1985 CJ10
605239	GM	36	Rear	1984-86 Corvette
605242	JEEP	70	Rear	1985 CJ 10A Military
605244	FORD	61	Rear	1985 F-350 - Full Float
605246	FORD	70	Rear	1985 F-350 Chassis - 70U
605247	FORD	70	Rear	1985 F-350 Chassis - 70U
605248	FORD	70	Rear	1985 F-350 Chassis - 70U
605249	FORD	70	Rear	1985 F-350 Heavy Duty Chassis - 70HD
605250	FORD	70	Rear	1985 F-350 6 Wheeler - 70HD
605251	FORD	60	Rear	1985 E-250 Van SRW - Semi Float

Bill of Material Number	Manufacturer	Model	Front / Rear	Application
605252	FORD	61	Rear	1985-86 E-350 Van - Full Float
605253	FORD	70	Rear	1985-86 E-350 Chassis - 70U
605254	FORD	60	Rear	1985 F-250 - Semi Float
605255	FORD	70	Rear	1985-87 F-350 DSO Ambulance - 70HD
605260	GM	36	Rear	1985-87 Corvette
605267	FORD	30	Rear	1985 1A Aerostar Van
605268	GM	60	Rear	1986-89 DRW G-Van 125" WB - Full Float
605269	CHRY	70	Rear	1985 1/2 D-300 & D-400 & D-500 & D-600
605270	CHRY	70	Rear	1985 1/2 D-300 & D-400 & D-500 & D-600
605273	FORD	30	Rear	1986-88 1A Aerostar Van
605285	JEEP	44	Rear	1986 Grand Wagoneer
605286	JEEP	44	Rear	1986 J10 Pickup
605287	JEEP	44	Rear	1986 XJ Metric Ton Truck
605289	JEEP	44	Rear	1986 CJ7
605290	JEEP	35	Rear	1986 XJ Utility
605291	JEEP	60	Rear	1986-88 J20 Pickup
605292	JEEP	35	Rear	1986 XJ Truck
605293	JEEP	35	Rear	1986 XJ Utility
605294	JEEP	35	Rear	1986 XJ Pickup
605295	JEEP	35	Rear	1987-89 YJ
605298	FORD	60	Rear	1986-88 E-250 Van SRW - Semi Float
605299	FORD	61	Rear	1987 E-350 Van - Full Float
605300	FORD	70	Rear	1987-88 E-350 Chassis - DRW - 70U
605302	GM	70	Rear	1988-90 SRW G-Van 30 - 70-3HD
605303	FORD	80	Rear	1988 F-350 Super Duty
605305	GM	70	Rear	1987 SRW C-30 - 70-3HD
605310	GM	70	Rear	1988-89 DRW G-Van 30 - 70-3HD
605311	CHRY	70	Rear	1987-90 1/2 D-200 & D-300 & D-600 & D-700 w/ABS
605312	CHRY	70	Rear	1989-90 1/2 D-200 & D-300 & D-600 & D-700 w/ABS
605313	CHRY	70	Rear	1987-90 D-300 & D-700 w/ABS
605315	JEEP	35	Rear	1985 1/2 XJ Utility
605316	JEEP	35	Rear	1985 1/2 XJ Utility
605321	GM	36	Rear	1988-90 Corvette
605322	GM	44	Rear	1989 1/2-90 Corvette
605323	JEEP	35	Rear	1987-89 XJ Utility
605324	JEEP	35	Rear	1987-89 XJ Pickup
605325	JEEP	44	Rear	1987-93 1/2 XJ Metric Ton Truck, XJ HD Truck
605329	JEEP	44	Rear	1987-92 Grand Wagoneer
605330	JEEP	44	Rear	1987-88 J10 Pickup
605331	GM	70	Rear	1987-91 1/2 R/V-30 - 70HD
605337	FORD	70	Rear	1988 1/2-89 E-350 U-Haul Chassis - 70HD
605339	JEEP	44	Rear	1988 1/2-96 1/2 YJ
605342	JEEP	44	Rear	1987-87 1/2 XJ Utility
605344	FORD	70	Rear	1987 1/2 E-350 Chassis - DRW - 70HD
605345	GM	70	Rear	1987 1/2-89 SRW C-30 - 70-3HD
605346	GM	70	Rear	1987 1/2-89 SRW K-30 - 70-3HD
605351	JEEP	35	Rear	1988-89 XJ Utility, Trailer Tow w/ABS
605352	FORD	70	Rear	1987 1/2 E-350 Chassis - DRW - 70U
605355	FORD	60	Rear	1988 E-350 Van SRW - Full Float
605361	GM	70	Rear	1988 P-30 Motor Home/Disc Brakes - 70HD
605363	GM	70	Rear	1988-89 P-30 Motor Home/Disc Brakes - 70HD
605365	GM	44	Rear	1988-89 Corvette
605368	CHRY	60	Rear	1989-90 1/2 D-300 & D-700 H.D. w/ABS

Bill of Material Numerical Listing

Bill of Material Number	Manufacturer	Model	Front / Rear	Application
605370	CHRY	60	Rear	1989-93 1/2 D-200 H.D. & D-600 H.D w/ABS
605371	CHRY	60	Rear	1989-93 1/2 D-200 H.D. & D-600 H.D w/ABS
605373	CHRY	70	Rear	1989-90 D-300 & D-700 w/ABS
605386	CHRY	70	Rear	1988-90 1/2 Front Section Motor Home
605387	JEEP	35	Rear	1988 1/2-89 XJ Utility, I-6 Automatic
605389	JEEP	35	Rear	1988 1/2-89 XJ Utility, Trailer Tow
605391	GM	70	Rear	1988-89 P-30 Motor Home/Disc Brakes - 70HD
605397	GM	70	Rear	1988-89 DRW C/K-30 - 70-3HD
605400	FORD	80	Rear	1989 F-350 Super Duty
605403	GM	60	Rear	1990 DRW G-Van 146" WB - Full Float
605405	GM	60	Rear	1990 DRW G-Van 125" WB - Full Float
605407	CHRY	70	Rear	1989-90 D-300
605408	CHRY	70	Rear	1989 D-300 Wide Track w/ABS
605412	FORD	70	Rear	1989 E-350 Chassis - DRW - 70U
605413	FORD	60	Rear	1989 E-350 Van SRW - Full Float
605414	FORD	60	Rear	1989 E-250 Van SRW - Semi Float
605415	GM	70	Rear	1989 1/2 P-300 UPS - 70HD
605416	JEEP	35	Rear	1990-90 1/2 XJ Utility
605417	GM	44	Rear	1990-90 1/2 Corvette
605418	GM	70	Rear	1989 1/2 G-Van Extended - 70-3HD
605419	FORD	60	Rear	1990-91 1/2 E-250 Van SRW - Semi Float w/ABS
605420	FORD	60	Rear	1990-91 1/2 E-250 Van SRW - Full Float w/ABS
605421	FORD	70	Rear	1990-91 1/2 E-350 Chassis - DRW - 70U w/ABS
605423	JEEP	35	Rear	1990-90 1/2 YJ
605425	JEEP	35	Rear	1990-90 1/2 MJ Pickup
605427	JEEP	35	Rear	1990-91 1/2 XJ Utility, Trailer Tow w/ABS
605434	FORD	30	Rear	1989 1/2 1A Aerostar Van
605437	FORD	70	Rear	1989-90 1/2 E-350 Motor Home - 70U
605438	FORD	70	Rear	1989-90 E-350 Motor Home - 70HD
605440	CHRY	60	Rear	1989-94 1/2 B-300 HD w/ABS
605441	CHRY	60	Rear	1989 B-300 Maxivan HD
605443	JEEP	35	Rear	1990-90 1/2 XJ Utility, I-6 Automatic
605444	JEEP	35	Rear	1990-90 1/2 XJ Utility, Trailer Tow
605445	FORD	80	Rear	1990-91 1/2 F-350 Super Duty
605449	GM	70	Rear	1990-91 1/2 SRW G-Van 30 - 70-3HD
605452	GM	70	Rear	1990 DRW G-Van 146" WB - 70U
605453	GM	70	Rear	1990 DRW G-Van 30 - 70-3HD
605454	GM	70	Rear	1990-91 1/2 G-Van Extended - 70-3HD
605455	JEEP	35	Rear	1988-89 XJ Pickup
605456	GM	70	Rear	1989 1/2-90 P-30 Motor Home/Disc Brakes - 70HD
605457	GM	70	Rear	1989 1/2-90 P-30 Motor Home/Disc Brakes - 70HD
605461	FORD	80	Rear	1992-93 1/2 F-450 Chassis-DRW-Full Float
605470	GM	70	Rear	1990 P-300 UPS - 70HD
605471	FORD	70	Rear	1990-91 1/2 E-350 Motor Home - 70HD w/ABS
605475	JEEP	35	Rear	1993-94 ZJ ABS DESCRIPTION 2
605480	FORD	70	Rear	1990-91 1/2 E-350 U-Haul Chassis - 70HD w/ABS
605483	JEEP	35	Rear	1990-92 1/2 XJ Utility
605484	JEEP	35	Rear	1990-92 1/2 XJ Utility, I-6 Automatic
605485	JEEP	35	Rear	1990-92 1/2 XJ Utility, Trailer Tow
605487	FORD	60	Rear	1992-93 1/2 E-350 Van SRW - Full Float w/ABS
605488	FORD	70	Rear	1992 E-350 Chassis - DRW - 70U w/ABS
605489	CHRY	70	Rear	1990 1/2 Air Force Tow Vehicle w/ABS
605490	GM	36	Rear	1990 1/2-96 1/2 Corvette

Bill of Material Number	Manufacturer	Model	Front / Rear	Application
605491	GM	44	Rear	1990-96 1/2 Corvette
605492	GM	44	Rear	1990 1/2 Corvette
605493	GM	70	Rear	1990 1/2-92 1/2 P-300 UPS - 70HD
605494	GM	70	Rear	1991-93 1/2 70HD
605495	GM	60	Rear	1990 1/2-91 1/2 DRW G-Van 146" WB - Full Float
605496	GM	60	Rear	1990 1/2-91 1/2 DRW G-Van 125" WB - Full Float
605497	GM	70	Rear	1990 1/2-91 1/2 DRW G-Van 146" WB - 70U
605498	GM	70	Rear	1990 1/2-91 1/2 DRW G-Van 30 - 70-3HD
605499	GM	80	Rear	1992 Motor Home/Disc Brakes - 80
605500	JEEP	35	Rear	1991-93 1/2 MJ Pickup
605501	FORD	70	Rear	1991-91 1/2 Continental Bakery Chassis - 70U w/ABS
605502	JEEP	35	Rear	1991-93 1/2 YJ
605507	JEEP	35	Rear	1993-94 ZJ T/TOW w/ABS
605508	CHRY	70	Rear	1991-93 1/2 D-200 & D-300 & D-600 & D-700 w/ABS
605509	CHRY	70	Rear	1991-93 1/2 D-200 & D-300 & D-600 & D-700 w/ABS
605510	CHRY	70	Rear	1991-93 1/2 D-300 & D-700 w/ABS
605511	CHRY	70	Rear	1991-93 1/2 D-300 & D-700 w/ABS
605512	CHRY	70	Rear	1991-93 1/2 D-300 Wide Track w/ABS
605513	CHRY	70	Rear	1987-93 D-300 Wide Track w/ABS
605514	CHRY	70	Rear	1991-93 1/2 Air Force Tow Vehicle w/ABS
605516	CHRY	60	Rear	1991-94 B-300 Maxivan w/ABS
605517	CHRY	60	Rear	1991-95 1/2 D-300 & D-700 H.D. w/ABS
605518	FORD	70	Rear	1990-91 1/2 UPS Chassis - 70U w/ABS
605522	CHRY	70	Rear	1991-93 1/2 D-300 & D-400 & D-500 & D-600 & D-700 w/ABS
605524	GM	80	Rear	1992 1/2-93 1/2 GMT 455 - 80
605525	JEEP	35	Rear	1992-93 1/2 YJ w/ABS
605526	GM	80	Rear	1992 1/2-93 1/2 P-TRUCK - 80
605527	GM	80	Rear	1992 1/2-93 1/2 P-TRUCK - 80
605528	JEEP	35	Rear	1993-93 1/2 YJ w/ABS
605529	CHRY	44	Rear	1993 1/2 Viper
605534	JEEP	35	Rear	1992 1/2-93 1/2 XJ Utility, STD
605535	JEEP	35	Rear	1992 1/2-93 1/2 XJ Utility, STD
605536	JEEP	35	Rear	1992 1/2-93 1/2 XJ Utility, STD
605537	FORD	70	Rear	1992 Continental Bakery Chassis - 70U w/ABS
605538	FORD	70	Rear	1992-93 1/2 E-350 Motor Home - 70HD w/ABS
605539	FORD	70	Rear	1992-93 1/2 E-350 U-Haul Chassis - 70HD w/ABS
605540	FORD	70	Rear	1992-92 1/2 UPS Chassis - 70U w/ABS
605541	JEEP	35	Rear	1992-93 1/2 YJ w/ABS
605547	CHRY	70	Rear	1991-93 1/2 D-300 & D-400 & D-500 & D-600 & D-700 w/ABS
605556	FORD	60	Rear	1992 E-250 Van SRW - Semi Float w/ABS
605558	GM	44	Rear	1992 1/2-94 F-Car
605559	GM	70	Rear	1993-94 P-300 UPS - 70HD
605564	JEEP	35	Rear	1992-93 1/2 YJ w/ABS
605567	FORD	70	Rear	1992 1/2-93 1/2 E-350 Chassis - DRW - 70U w/ABS
605569	FORD	60	Rear	1993-95 E-250 Van SRW - Semi Float
605575	GM	80	Rear	1993-93 1/2 GMT 455 - 80
605578	FORD	70	Rear	1992 1/2-93 1/2 E-350 SRW Cutaway, Wide Track 70 2U
605579	JEEP	35	Rear	1993-94 XJ Utility w/ABS
605583	FORD	70	Rear	1992 1/2-93 1/2 Continental Bakery Chassis - 70U w/ABS
605584	FORD	70	Rear	1992 1/2-93 1/2 UPS Chassis - 70U w/ABS
605585	CHRY	60	Rear	1994-95 1/2 D2500
605586	CHRY	60	Rear	1994-95 1/2 W2500
605588	CHRY	70	Rear	1994-95 1/2 W2500

Bill of Material Numerical Listing

Bill of Material Number	Manufacturer	Model	Front / Rear	Application
605590	CHRY	70	Rear	1994-95 1/2 D2500
605592	CHRY	80	Rear	1994-95 1/2 W3500
605593	CHRY	80	Rear	1994-95 1/2 D3500 w/ABS
605594	CHRY	80	Rear	1994-95 1/2 D/W3500 w/ABS
605595	CHRY	80	Rear	1994-95 1/2 D2500
605596	CHRY	80	Rear	1994-95 1/2 W2500
605601	GM	80	Rear	1993-96 1/2 Motor Home/Disc Brakes - 80
605602	JEEP	35	Rear	1994 ZJ ABS DESCRIPTION 2
605607	JEEP	35	Rear	1994 ZJ ABS DESCRIPTION 2
605608	FORD	70	Rear	1993 1/2-94 E-350 Chassis - DRW - 70U w/ABS
605609	FORD	70	Rear	1993 1/2-94 E-350 Motor Home - 70HD w/ABS
605623	FORD	60	Rear	1993-94 E-250 Van SRW - Semi Float w/ABS
605624	FORD	60	Rear	1993 1/2-94 E-350 Van SRW - Full Float
605632	FORD	80	Rear	1993-94 1/2 F-450 Chassis-DRW-Full Float
605633	CHRY	60	Rear	1994-95 1/2 D2500
605634	CHRY	60	Rear	1994-95 1/2 W2500
605638	GM	80	Rear	1994 1/2-95 1/2 P-TRUCK - 80
605639	FORD	60	Rear	1994-95 E-350 Van SRW - Full Float
605640	FORD	70	Rear	1994-94 1/2 E-350 Chassis - 70U
605643	GM	80	Rear	1993 1/2-95 1/2 P-TRUCK - 80
605644	GM	80	Rear	1993-95 1/2 P-TRUCK - 80
605648	CHRY	44	Rear	1994-95 1/2 Viper
605649	GM	80	Rear	1995-95 1/2 GMT 455 - 80
605655	JEEP	35	Rear	1994 XJ Utility, STD
605656	JEEP	35	Rear	1994 XJ Utility
605657	JEEP	35	Rear	1994 XJ Utility w/ABS
605658	JEEP	35	Rear	1994 XJ Utility w/ABS
605659	JEEP	35	Rear	1994 XJ Utility w/ABS
605660	JEEP	35	Rear	1994 XJ Utility
605661	JEEP	35	Rear	1994-96 YJ/TJ
605662	JEEP	35	Rear	1994-96 YJ/TJ w/ABS
605665	FORD	70	Rear	1993 1/2-94 E-350 Chassis - DRW - 70U w/ABS
605666	FORD	70	Rear	1993 1/2-94 E-350 Chassis - DRW - 70U w/ABS
605667	FORD	70	Rear	1993 1/2-94 1/2 E-350 Chassis - DRW - 70U w/ABS
605669	FORD	70	Rear	1993 1/2-94 E-350 SRW Cutaway, Wide Track 70 2U
605670	FORD	60	Rear	1994-94 1/2 E-350 Van SRW - Full Float
605671	FORD	70	Rear	1994 E-350 Chassis - DRW - 70U w/ABS
605672	FORD	70	Rear	1994-94 1/2 E-350 Motor Home - 70HD w/ABS
605673	FORD	70	Rear	1994-94 1/2 E-350 Chassis - DRW - 70U w/ABS
605674	FORD	70	Rear	1994-94 1/2 E-350 SRW Cutaway, Wide Track 70 2U
605675	FORD	70	Rear	1994-94 1/2 E-350 Motor Home - 70HD w/ABS
605684	FORD	60	Rear	1995-96 E-350 Van SRW - Full Float
605685	FORD	60	Rear	1995-96 E-350 Van SRW - Full Float
605686	FORD	70	Rear	1995-95 1/2 E-350 SRW Cutaway, Wide Track 70 2U
605687	FORD	70	Rear	1995-95 1/2 E-350 Chassis - DRW - 70U
605688	FORD	70	Rear	1995-95 1/2 E-350 Motor Home - 70HD
605689	FORD	70	Rear	1995-95 1/2 E-350 Chassis - DRW - 70U
605690	FORD	70	Rear	1995-95 1/2 E-350 Motor Home - 70HD w/ABS
605691	GM	80	Rear	1995-95 1/2 GMT 455 - 80
605692	FORD	70	Rear	1994 E-350 Chassis - DRW - 70HD
605693	FORD	70	Rear	1994 E-350 Chassis - DRW - 70HD
605695	GM	80	Rear	1994 1/2-95 1/2 GMT 455 - 80
605700	FORD	60	Rear	1995-96 E-250 Van SRW - Semi Float w/ABS

Bill of Material Number	Manufacturer	Model	Front / Rear	Application
605706	JEEP	35	Rear	1995-96 ZJ ABS DESCRIPTION 2
605707	JEEP	35	Rear	1995-96 ZJ ABS DESCRIPTION 2
605710	CHRY	60	Rear	1994 1/2-97 1/2 B-300 VAN w/ABS
605711	CHRY	60	Rear	1994 1/2-97 1/2 B-300 VAN w/ABS
605712	GM	80	Rear	1994 1/2-95 1/2 P-TRUCK - 80
605713	FORD	60	Rear	1994 1/2 E-350 Van SRW - Full Float w/ABS
605714	FORD	70	Rear	1994 1/2-95 E-350 Chassis - DRW - 70HD
605715	FORD	70	Rear	1994 1/2-95 E-350 Motor Home - 70HD w/ABS
605717	FORD	80	Rear	1995-95 1/2 F-450 Chassis-DRW-Full Float
605718	CHRY	80	Rear	1995-97 Sweptline Vehicle
605719	GM	80	Rear	1995-95 1/2 Motor Home/Disc Brakes - 80
605722	CHRY	70	Rear	1995-95 1/2 Air Force Tow Vehicle w/ABS
605723	CHRY	70	Rear	1995-95 1/2 D2500 Air Force Tow Vehicle w/ABS
605725	JEEP	35	Rear	1994 XJ Utility w/ABS
605727	JEEP	35	Rear	1995-96 1/2 XJ Utility w/ABS
605728	JEEP	35	Rear	1995-96 XJ Utility, STD
605729	JEEP	35	Rear	1995-96 XJ Utility
605730	JEEP	35	Rear	1995-96 1/2 XJ Utility w/ABS
605731	JEEP	35	Rear	1995-96 XJ Utility w/ABS
605732	JEEP	35	Rear	1995-96 1/2 XJ Utility w/ABS
605733	JEEP	35	Rear	1995-96 1/2 XJ Utility
605735	JEEP	44	Rear	1996-99 ZJ ABS DESCRIPTION 2
605745	GM	80	Rear	1994 1/2-95 1/2 P-TRUCK - 80
605746	JEEP	35	Rear	1996 1/2 YJ/TJ w/ABS
605747	JEEP	35	Rear	1996 1/2 YJ/TJ
605750	FORD	60	Rear	1995-97 E-250 Van SRW - Semi Float w/ABS
605752	CHRY	44	Rear	1996-97 Viper
605753	GM	80	Rear	1995 1/2-95 1/2 GMT 455 - 80
605767	GM	80	Rear	1995-95 1/2 P-TRUCK - 80
605775	JEEP	35	Rear	1996-96 1/2 XJ Diesel
605776	JEEP	35	Rear	1996-96 1/2 XJ Diesel
605783	GM	80	Rear	1995-95 1/2 P-TRUCK - 80
605784	CHRY	60	Rear	1996-96 1/2 D2500
605785	CHRY	60	Rear	1996 W2500
605786	CHRY	70	Rear	1996 W2500
605787	CHRY	70	Rear	1996-96 1/2 D2500
605788	CHRY	80	Rear	1996-96 1/2 W3500
605789	CHRY	80	Rear	1996-96 1/2 D3500 w/ABS
605790	CHRY	80	Rear	1996-96 1/2 D/W3500 w/ABS
605791	CHRY	80	Rear	1996-96 1/2 D2500
605792	CHRY	80	Rear	1996 1/2 D2500
605793	CHRY	60	Rear	1996-96 1/2 D2500
605794	CHRY	60	Rear	1996 1/2 W2500
605797	JEEP	35	Rear	1996 1/2-97 ZJ ABS - DESCRIPTION 1
605798	JEEP	35	Rear	1996 1/2-97 ZJ ABS - DESCRIPTION 1
605807	FORD	80	Rear	1997-98 E-350 DRW Chassis - Full Float
605810	GM	80	Rear	1996-96 1/2 P-TRUCK - 80
605811	GM	80	Rear	1996-96 1/2 P-TRUCK - 80
605812	GM	80	Rear	1996-98 P-TRUCK - 80
605813	GM	80	Rear	1996 1/2 P-TRUCK - 80
605814	GM	80	Rear	1996-98 P-TRUCK - 80
605815	GM	80	Rear	1996-98 P-TRUCK - 80
605816	GM	80	Rear	1996-98 P-TRUCK - 80

Bill of Material Numerical Listing

Bill of Material Number	Manufacturer	Model	Front / Rear	Application
605817	GM	80	Rear	1996-96 1/2 P-TRUCK - 80
605818	GM	80	Rear	1996-97 P-TRUCK - 80
605831	FORD	80	Rear	1996-98 F-450 Chassis-DRW-Full Float
605834	FORD	80	Rear	1996 E-350 DRW Chassis - Full Float
605838	GM	80	Rear	1996 1/2-97 P-TRUCK - 80
605839	GM	80	Rear	1996 1/2-97 P-TRUCK - 80
605840	GM	80	Rear	1996 1/2-97 P-TRUCK - 80
605841	FORD	60	Rear	1996-96 1/2 E-250 Van SRW - Semi Float w/ABS
605842	FORD	60	Rear	1996-96 1/2 E-350 Van SRW - Full Float
605843	FORD	60	Rear	1996 E-350 Van SRW - Full Float w/ABS
605844	FORD	70	Rear	1995-95 1/2 E-350 SRW Cutaway, Wide Track 70 2U
605845	FORD	70	Rear	1995-95 1/2 E-350 Chassis - DRW - 70U w/ABS
605846	FORD	70	Rear	1996-97 E-350 Motor Home - 70HD w/ABS
605847	FORD	70	Rear	1996-97 E-350 Chassis - DRW - 70U w/ABS
605848	FORD	70	Rear	1996-97 E-350 Motor Home - 70HD w/ABS
605849	JEEP	44	Rear	1997 TJ
605858	GM	80	Rear	1996 1/2 GMT 455 - 80
605859	FORD	60	Rear	1996-97 E-250 Van SRW - Semi Float w/ABS
605860	FORD	70	Rear	1996-97 E-350 Chassis - DRW - 70U w/ABS
605861	FORD	70	Rear	1996-97 E-350 Chassis - DRW - 70U w/ABS
605862	FORD	70	Rear	1996-97 E-350 Chassis - DRW - 70U w/ABS
605867	GM	80	Rear	1996-99 GMT 455 - 80
605868	GM	80	Rear	1996-98 GMT 455 - 80
605869	GM	80	Rear	1996-98 GMT 455 - 80
605871	CHRY	60	Rear	1998 B-300 VAN w/ABS
605879	CHRY	70	Rear	1996-97 1/2 W2500 Air Force Tow Vehicle w/ABS
605880	CHRY	70	Rear	1996-97 1/2 W2500 Air Force Tow Vehicle w/ABS
605893	JEEP	35	Rear	1996 1/2 XJ Utility, STD
605894	JEEP	35	Rear	1996 1/2 XJ Utility
605895	JEEP	35	Rear	1996 1/2 XJ Utility w/ABS
605896	GM	80	Rear	1996 1/2-97 P-TRUCK - 80
605898	CHRY	60	Rear	1997-97 1/2 D2500
605899	CHRY	60	Rear	1996 W2500
605900	CHRY	70	Rear	1996 W2500
605901	CHRY	70	Rear	1996-97 D2500
605902	CHRY	80	Rear	1997 W3500
605903	CHRY	80	Rear	1997 D3500 w/ABS
605904	CHRY	80	Rear	1997 D/W3500 w/ABS
605905	CHRY	80	Rear	1997 D2500
605906	CHRY	80	Rear	1997 W2500
605907	CHRY	60	Rear	1997-97 1/2 D2500
605908	CHRY	60	Rear	1997-97 1/2 W2500
605909	JEEP	35	Rear	1996 1/2 XJ Diesel w/ABS
605913	JEEP	35	Rear	1997 XJ Utility w/ABS
605914	JEEP	35	Rear	1997 XJ Utility w/ABS
605916	JEEP	35	Rear	1997 XJ Diesel
605918	JEEP	35	Rear	1997 XJ Utility w/ABS
605919	JEEP	35	Rear	1997 XJ Diesel w/ABS
605920	FORD	60	Rear	1996-99 E-250 Van SRW - Semi Float w/ABS
605921	FORD	60	Rear	1996-99 E-250 Van SRW - Semi Float w/ABS
605924	FORD	80	Rear	1998 1/2-99 1/2 F-350 Chassis DRW Full Float w/ABS
605925	FORD	80	Rear	1998 1/2-99 1/2 F-450 Chassis-DRW-Full Float
605926	FORD	80	Rear	1998 1/2-2000 F-350 Pick-Up DRW-Full Float

Bill of Material Number	Manufacturer	Model	Front / Rear	Application
605929	FORD	70	Rear	1996 E-350 Motor Home - 70HD w/ABS
605933	FORD	60	Rear	1996 1/2-97 E-250 Van SRW - Semi Float w/ABS
605934	FORD	60	Rear	1996 1/2 E-350 Van SRW - Full Float
605935	FORD	60	Rear	1996 1/2 E-350 Van SRW - Full Float
605942	FORD	80	Rear	1998 1/2-99 1/2 F-350 Chassis DRW Full Float w/ABS
605947	FORD	60	Rear	1997 1/2 E-250 Van SRW - Semi Float w/ABS
605948	FORD	60	Rear	1997 1/2 E-350 Van SRW - Full Float
605949	FORD	60	Rear	1997 1/2 E-350 Van SRW - Full Float
605950	FORD	70	Rear	1997 E-350 SRW Cutaway, Wide Track 70 2U
605951	FORD	70	Rear	1997 E-350 Chassis - DRW - 70U w/ABS
605952	JEEP	44	Rear	1997 TJ RHD
605956	JEEP	35	Rear	1997 TJ ABS
605957	JEEP	35	Rear	1997 TJ
605960	JEEP	35	Rear	1997-98 1/2 ZJ w/ABS ENTRY 5
605961	JEEP	35	Rear	1997-98 1/2 ZJ w/ABS ENTRY 5
605962	JEEP	44	Rear	1997-98 1/2 ZJ ABS DESCRIPTION 2
605965	CHRY	60	Rear	1998 B-300 VAN w/ABS
605975	CHRY	80	Rear	1997 1/2 W3500
605976	CHRY	80	Rear	1997 1/2 D3500 w/ABS
605977	CHRY	80	Rear	1997 1/2 D/W3500 w/ABS
605978	CHRY	60	Rear	1998-98 1/2 D2500
605979	CHRY	60	Rear	1998 W2500
605980	CHRY	70	Rear	1998 W2500
605981	CHRY	70	Rear	1998 D2500
605982	CHRY	80	Rear	1998-98 1/2 W3500
605983	CHRY	80	Rear	1998-98 1/2 D3500 w/ABS
605984	CHRY	80	Rear	1998-98 1/2 D/W3500 w/ABS
605985	CHRY	80	Rear	1998-98 1/2 D2500
605987	CHRY	60	Rear	1998-98 1/2 D2500
605988	CHRY	60	Rear	1998-98 1/2 W2500
605992	JEEP	35	Rear	1997 1/2-2000 TJ ABS
605993	JEEP	35	Rear	1997 1/2-2000 TJ
606012	CHRY	70	Rear	1997-98 W2500 Air Force Tow Vehicle w/ABS
606013	CHRY	70	Rear	1997-98 D2500 Air Force Tow Vehicle w/ABS
606014	CHRY	44	Rear	1998-2000 Viper
606015	JEEP	44	Rear	1998-99 TJ
606016	JEEP	44	Rear	1997 1/2-99 TJ RHD
606017	FORD	60	Rear	1998-98 1/2 E-250 Van SRW - Semi Float w/ABS
606020	FORD	70	Rear	1998-98 1/2 E-350 SRW Cutaway, Wide Track 70U
606021	FORD	70	Rear	1998-98 1/2 E-350 Chassis - DRW - 70U w/ABS
606028	FORD	70	Rear	1997 1/2-98 1/2 E-350 Chassis - DRW
606029	FORD	60	Rear	1997 1/2-98 E-250 Van SRW - Semi Float w/ABS
606031	JEEP	35	Rear	1997 1/2-99 XJ Utility w/ABS
606032	JEEP	35	Rear	1997 1/2-99 XJ Utility w/ABS
606033	JEEP	35	Rear	1997 1/2-99 XJ Diesel
606034	JEEP	35	Rear	1997 1/2-99 XJ Utility w/ABS
606035	JEEP	35	Rear	1997 1/2-99 XJ Diesel w/ABS
606040	GM	80	Rear	1997-2000 P-TRUCK - 80
606041	GM	80	Rear	1997-2000 P-TRUCK - 80
606042	GM	80	Rear	1997-2000 P-TRUCK - 80
606043	GM	80	Rear	1997-2000 P-TRUCK - 80
606046	JEEP	44	Rear	1998-98 1/2 ZJ ABS DESCRIPTION 2
606047	JEEP	44	Rear	1998-98 1/2 ZJ ABS DESCRIPTION 2

Bill of Material Numerical Listing

Bill of Material Number	Manufacturer	Model	Front / Rear	Application
606049	FORD	60	Rear	1998 E-350 Van SRW - Full Float w/ABS
606050	FORD	60	Rear	1998 E-350 Van SRW - Full Float w/ABS
606054	CHRY	60	Rear	1997 1/2 W2500
606055	CHRY	70	Rear	1997 W2500
606056	CHRY	80	Rear	1997 1/2 W2500
606058	CHRY	60	Rear	1998-98 1/2 B-300 VAN w/ABS
606059	CHRY	60	Rear	1998-98 1/2 B-300 VAN w/ABS
606062	CHRY	60	Rear	1998-98 1/2 W2500
606063	CHRY	70	Rear	1998 W2500
606064	CHRY	80	Rear	1998-98 1/2 W2500
606073	GM	80	Rear	1998 1/2-99 GMT 455 - 80
606074	GM	80	Rear	1998 1/2-99 GMT 455 - 80
606076	FORD	80	Rear	1998 1/2 E-350 Super Duty - DRW - Full Float
606094	CHRY	70	Rear	1998 D2500
606095	CHRY	70	Rear	1998 W2500
606102	FORD	60	Rear	1998 1/2-99 E-250 Van SRW - Semi Float w/ABS
606103	JEEP	35	Rear	1998 1/2-99 XJ Utility
606108	CHRY	60	Rear	1998 B-300 VAN w/ABS
606123	GM	80	Rear	1998 1/2-99 GMT 455 - 80
606158	FORD	70	Rear	1998 1/2-99 E-350 Cutaway SRW or Chassis DRW Option
606159	FORD	70	Rear	1998 1/2 E-350 DRW Chassis - Full Float
606160	FORD	70	Rear	1998 E350 Chassis - DRW w/ABS
606161	FORD	60	Rear	1998 1/2-99 E-250 Van SRW - Semi Float w/ABS
606162	FORD	60	Rear	1998 1/2-99 E-350 Van SRW - Full Float w/ABS
606163	FORD	60	Rear	1998 E-250 Van SRW - Semi Float w/ABS
610023	FORD	60	Front	1978-79 F-250 & F-350 (Snow Fighter)
610027	CHRY	44	Front	1979 W-100
610028	CHRY	44	Front	1979 W-200
610053	JEEP	30	Front	1979 CJ5/CJ7 - External Type Wheel End
610054	GM	44	Front	1979 Blazer & K-10
610055	GM	44	Front	1978-79 K-20
610056	GM	44	Front	1979 K-20
610057	GM	60	Front	1979-80 K-30
610062	FORD	44	Front	1980 Bronco II & F-150 Pick-Up with Part Time Transfer Case
610063	FORD	44	Front	1980 F-250 3/4-Ton Pick-Up (Part Time Transfer Case)
610064	FORD	50	Front	1980 F-350
610066	FORD	44	Front	1979 F-150 1/2 Ton Pick-Up (Full Time Transfer Case)
610067	FORD	44	Front	1979 F-150 1/2 Ton Pick-Up (Part-Time Transfer Case)
610068	FORD	44	Front	1979 F-150 Super Cab
610069	FORD	44	Front	1979 F-250
610076	CHRY	44	Front	1980 W-100
610077	CHRY	44	Front	1980 W-200
610078	JEEP	30	Front	1980-81 IFS - Eagle - Non-Disconnect
610079	GM	44	Front	1980 K-20
610080	GM	44	Front	1979-80 K-20
610081	GM	44	Front	1979-80 K-20
610084	CHRY	44	Front	1980-83 W-200
610086	JEEP	30	Front	1980 CJ5/CJ7 - External Type Wheel End
610089	JEEP	44	Front	1980 J10, J20, Wide Track Cherokee
610090	JEEP	44	Front	1980 Wagoneer / Cherokee
610127	CHRY	44	Front	1981-84 W-100
610128	CHRY	44	Front	1981-84 W-200
610132	GM	60	Front	1981 K-30

Bill of Material Number	Manufacturer	Model	Front / Rear	Application
610134	JEEP	30	Front	1981 IFS - Eagle - Disconnect
610135	CHRY	60	Front	1981-85 D-600 & D-700
610136	JEEP	30	Front	1981 CJ5/CJ7 - External Type Wheel End
610139	JEEP	44	Front	1981-85 J10, J20, Wide Track Cherokee
610140	JEEP	44	Front	1981-85 Wagoneer / Cherokee
610146	FORD	44	Front	1981 F-250 & F-350 HD
610147	FORD	50	Front	1981-82 F-250 & F-350 (Snow Fighter)
610152	JEEP	30	Front	1982-82 1/2 IFS - Eagle - Non-Disconnect
610153	JEEP	30	Front	1982-82 1/2 IFS - Eagle - Disconnect
610154	JEEP	30	Front	1981 1/2 CJ5/CJ7 - External Type Wheel End
610156	JEEP	30	Front	1982-83 CJ5 - External Type Wheel End
610157	JEEP	44	Front	1982-84 Wagoneer, Cherokee Disconnect STD Track
610158	JEEP	44	Front	1982-84 J10, J20, Wide Track Cherokee
610159	GM	60	Front	1982-87 K-30
610160	CHRY	44	Front	1985-89 D-600 (Export)
610164	JEEP	30	Front	1982-87 CJ7/CJ8 - External Type Wheel End
610166	FORD	44	Front	1981 1/2-82 F-150 Snow Plow
610167	FORD	44	Front	1983 F-150 Snow Plow
610168	FORD	44	Front	1983 Bronco & F-150
610169	FORD	44	Front	1983 F-250 & F-350 HD
610170	FORD	50	Front	1983 F-250
610171	FORD	28	Front	1983-84 Ranger
610172	JEEP	30	Front	1984 XJ Disconnect, CV
610173	JEEP	30	Front	1983-84 IFS - Eagle - Non-Disconnect
610174	JEEP	30	Front	1983-84 IFS - Eagle - Disconnect
610175	JEEP	30	Front	1984-87 XJ Disconnect, Cardan
610177	FORD	44	Front	1984 F-150 Snow Plow
610178	FORD	44	Front	1984 Bronco & F-150
610179	FORD	44	Front	1984 F-250 & F-350 HD
610180	FORD	50	Front	1984 F-250 & F-350 (Snow Fighter)
610182	JEEP	30	Front	1984-85 XJ Disconnect, Cardan, System Sentry
610183	JEEP	30	Front	1985-87 XJ Non-Disconnect, Cardan - Live Spindle Wheel End
610185	FORD	44	Front	1981-82 Bronco II & F-150
610197	FORD	44	Front	1984 1/2-85 F-150 Snow Plow
610198	FORD	44	Front	1984 1/2-85 Bronco & F-150
610199	FORD	44	Front	1984 1/2-85 F-250
610200	FORD	50	Front	1984 1/2 F-250 & F-350 (Snow Fighter)
610201	GM	60	Front	1984-88 CUCV
610202	GM	60	Front	1984-85 K-30
610206	JEEP	30	Front	1985 XJ Non-Disconnect, Cardan - Live Spindle Wheel End
610216	CHRY	44	Front	1985-86 D-500 & D-800
610217	CHRY	44	Front	1985-86 D-600
610220	FORD	60	Front	1985 F-350
610221	JEEP	30	Front	1985 XJ Non-Disconnect, CV, System Sentry - Live Spindle Wheel End
610222	JEEP	30	Front	1985-86 XJ Non-Disconnect, CV - Live Spindle Wheel End
610223	FORD	28	Front	1984 1/2-85 Ranger/Bronco II
610227	JEEP	44	Front	1985 Grand Wagoneer
610228	JEEP	44	Front	1985 4X2, Military - Dead Front
610229	FORD	44	Front	1985 F-250
610230	FORD	50	Front	1985 F-250 & F-350 (Snow Fighter)
610231	FORD	44	Front	1985 F-250 & F-350 HD
610232	FORD	50	Front	1985 1/2 F-350
610234	JEEP	30	Front	1985-86 XJ 4X2, System Sentry (Dead Front)

Bill of Material Numerical Listing

Bill of Material Number	Manufacturer	Model	Front / Rear	Application
610235	JEEP	30	Front	1985-87 1/2 IFS - Eagle - Non-Disconnect - CV
610236	CHRY	60	Front	1985-88 D-600 & D-700
610237	JEEP	30	Front	1985 XJ 4X2, System Sentry (Dead Front)
610241	FORD	44	Front	1985 1/2 Bronco & F-150
610242	FORD	44	Front	1985 1/2 F-150 Snow Plow
610243	FORD	44	Front	1985 1/2 F-250
610244	JEEP	30	Front	1986 CJ7, LH Steering, H/L - External Type Wheel End
610246	JEEP	44	Front	1986 J10
610247	JEEP	44	Front	1986 Grand Wagoneer
610248	JEEP	44	Front	1986 J20
610249	FORD	28	Front	1986-87 Ranger/Bronco II
610254	FORD	50	Front	1986-87 F-250 & F-350 (Snow Fighter)
610255	FORD	60	Front	1986-88 F-350 Monobeam DRW
610256	JEEP	30	Front	1986-89 XJ 4X2 (Dead Front)
610257	CHRY	44	Front	1986 1/2-87 1/2 D-500 & D-800
610258	CHRY	44	Front	1986-87 1/2 D-600
610259	JEEP	30	Front	1986 YJ Disconnect
610261	FORD	44	Front	1986 Bronco & F-150
610262	FORD	44	Front	1986 Bronco & F-150
610263	FORD	44	Front	1986 F-150 Snow Plow
610264	FORD	44	Front	1986-87 F-250
610265	CHRY	61	Front	1987-88 D-600 & D-700
610266	FORD	44	Front	1987-88 F-150 Snow Plow
610267	FORD	44	Front	1987-88 Bronco & F-150
610268	FORD	44	Front	1987-88 Bronco & F-150
610269	JEEP	30	Front	1986 YJ Non-Disconnect - Live Spindle Wheel End
610270	CHRY	44	Front	1992-93 1/2 D-600 & D-800
610271	CHRY	44	Front	1992-93 1/2 D-600
610277	CHRY	44	Front	1988-88 1/2 D-500 & D-800
610278	CHRY	44	Front	1988-88 1/2 D-600
610279	JEEP	30	Front	1987 1/2-88 XJ Disconnect
610280	JEEP	30	Front	1987 1/2-88 XJ Non-Disconnect - Live Spindle Wheel End
610281	JEEP	30	Front	1987-88 YJ Disconnect
610282	JEEP	30	Front	1987-88 YJ Non-Disconnect - Live Spindle Wheel End
610283	JEEP	44	Front	1987-88 Grand Wagoneer
610284	JEEP	44	Front	1987-87 1/2 J10
610285	JEEP	44	Front	1987-87 1/2 J20
610294	JEEP	30	Front	1987 1/2-88 XJ Non-Disconnect, ABS, Anti Skid - Live Spindle Wheel End
610295	GM	60	Front	1988-91 1/2 V-30
610297	JEEP	30	Front	1988 XJ Disconnect, Valeo Export
610298	FORD	28	Front	1987 1/2 Ranger/Bronco II
610300	FORD	35	Front	1990 Ranger/Bronco II
610303	FORD	28	Front	1990-92 Aerostar
610304	FORD	50	Front	1988-88 1/2 F-250 & F-350 (Snow Fighter)
610305	FORD	60	Front	1988 F-350 Monobeam SRW
610306	FORD	44	Front	1988 F-250
610307	FORD	28	Front	1988-89 Ranger/Bronco II
610309	FORD	44	Front	1988 1/2 F-150 Snow Plow, Bronco
610310	FORD	44	Front	1988 1/2-92 Bronco & F-150
610311	FORD	44	Front	1988 1/2-91 Bronco & F-150
610312	FORD	50	Front	1989-92 1/2 F-250 & F-350 (Snow Fighter)
610313	FORD	60	Front	1988 1/2-91 1/2 F-350 Monobeam SRW
610316	JEEP	30	Front	1992 1/2-93 1/2 XJ 4X2 (Dead Front)

Bill of Material Number	Manufacturer	Model	Front / Rear	Application
610317	JEEP	30	Front	1990-90 1/2 XJ Disconnect
610318	JEEP	30	Front	1990-91 1/2 XJ Non-Disconnect - Live Spindle Wheel End
610319	JEEP	30	Front	1990-90 1/2 YJ Disconnect
610320	JEEP	30	Front	1990-91 1/2 YJ Non-Disconnect - Live Spindle Wheel End
610321	JEEP	30	Front	1988 1/2-89 XJ Disconnect
610322	JEEP	30	Front	1988 1/2-89 XJ Non-Disconnect - Live Spindle Wheel End
610323	JEEP	30	Front	1988 1/2-89 YJ Disconnect
610324	JEEP	30	Front	1988 1/2-89 YJ Non-Disconnect - Live Spindle Wheel End
610325	JEEP	44	Front	1988 1/2-92 Grand Wagoneer
610327	JEEP	30	Front	1988 1/2-89 XJ Non-Disconnect, ABS, Anti Skid - Live Spindle Wheel End
610328	JEEP	30	Front	1988 1/2-89 XJ Disconnect, Valeo Export
610329	CHRY	44	Front	1988-88 1/2 D-500 & D-800
610331	CHRY	44	Front	1989-90 D-600
610332	CHRY	60	Front	1989 D-600 & D-700
610333	CHRY	61	Front	1989 D-600 & D-700
610334	JEEP	30	Front	1988 XJ Non-Disconnect, Valeo Export - Live Spindle Wheel End
610335	FORD	44	Front	1988 1/2-92 Bronco & F-150
610336	JEEP	30	Front	1990-91 1/2 XJ Non-Disconnect, ABS - Live Spindle
610337	JEEP	30	Front	1988 1/2-89 XJ Non-Disconnect, Valeo Export - Live Spindle Wheel End
610339	JEEP	30	Front	1990-90 1/2 XJ Disconnect, Valeo Export
610340	JEEP	30	Front	1990-90 1/2 XJ Non-Disconnect, Valeo Export - Live Spindle Wheel End
610341	CHRY	60	Front	1989-90 D-600
610342	CHRY	61	Front	1989 D-600 & D-700
610346	JEEP	30	Front	1992 1/2-93 ZJ ABS, CV Joint
610348	JEEP	30	Front	1992-93 1/2 XJ 4X2 (Dead Front) w/ABS
610351	JEEP	30	Front	1990 1/2-91 1/2 XJ 4X2 (Dead Front)
610355	CHRY	44	Front	1990-91 1/2 D-500 & D-800
610356	CHRY	44	Front	1991-91 1/2 D-600
610357	CHRY	60	Front	1991-91 1/2 D-600
610358	CHRY	61	Front	1991-92 D-600 & D-700
610360	CHRY	44	Front	1991-91 1/2 D-600
610361	JEEP	30	Front	1991-91 1/2 XJ Disconnect
610362	JEEP	30	Front	1991-91 1/2 YJ Disconnect
610363	JEEP	30	Front	1991 XJ Disconnect
610365	FORD	35	Front	1990 1/2-92 1/2 Ranger/Bronco II
610366	FORD	35	Front	1990 1/2-92 1/2 Explorer
610367	JEEP	30	Front	1995-97 XJ Non-Disconnect, Cardan - Live Spindle Wheel End
610369	FORD	28	Front	1992 1/2 Aerostar
610371	FORD	60	Front	1992 F-350 (Uses Socket Assy Instead of King Pin Assy)
610373	JEEP	30	Front	1991 XJ Non-Disconnect
610375	JEEP	30	Front	1991 XJ 4X2 (Dead Front)
610379	JEEP	30	Front	1992-93 1/2 XJ Non-Disconnect w/ABS
610381	JEEP	30	Front	1993-93 1/2 YJ Disconnect w/ABS
610383	JEEP	30	Front	1993-93 1/2 XJ Non-Disconnect - Live Spindle Wheel End
610391	JEEP	30	Front	1992-93 1/2 XJ Non-Disconnect
610392	JEEP	30	Front	1992-93 1/2 YJ Non-Disconnect
610393	JEEP	30	Front	1992-93 1/2 YJ Disconnect
610398	CHRY	60	Front	1992 D-600
610400	JEEP	30	Front	1993 ZJ (Dead Front) w/ABS
610401	JEEP	30	Front	1991 1/2 XJ Disconnect
610402	JEEP	30	Front	1991 1/2 XJ Non-Disconnect
610403	JEEP	30	Front	1991 1/2 XJ Non-Disconnect w/ABS
610404	JEEP	30	Front	1991 1/2-92 1/2 XJ 4X2 (Dead Front)

Bill of Material Numerical Listing

Bill of Material Number	Manufacturer	Model	Front / Rear	Application
610405	CHRY	60	Front	1993 D-600 & D-700
610406	CHRY	61	Front	1993-93 1/2 D-600 & D-700
610407	FORD	44	Front	1992 1/2 Bronco & F-150
610408	FORD	44	Front	1992 1/2 Bronco & F-150
610410	FORD	35	Front	1993-94 1/2 Explorer w/ABS
610411	FORD	44	Front	1993-93 1/2 Bronco w/ABS
610413	JEEP	30	Front	1993-93 1/2 XJ Non-Disconnect, ABS - Live Spindle
610414	FORD	44	Front	1993-93 1/2 Bronco & F-150
610416	JEEP	30	Front	1993-93 1/2 XJ 4X2 (Dead Front) w/ABS
610417	JEEP	30	Front	1993-93 1/2 XJ Non-Disconnect w/ABS
610418	FORD	28	Front	1993-94 1/2 Ranger
610419	FORD	35	Front	1993-94 1/2 Ranger
610422	CHRY	44	Front	1994-94 1/2 W1500
610423	CHRY	44	Front	1994-94 1/2 W2500
610424	CHRY	44	Front	1994-94 1/2 W1500
610425	CHRY	44	Front	1994-94 1/2 W2500
610426	CHRY	60	Front	1994-94 1/2 W2500 HD w/ABS
610427	CHRY	60	Front	1994 D3500 (Dead Front)
610428	CHRY	60	Front	1994-94 1/2 W3500
610430	CHRY	60	Front	1992-92 1/2 D-600 & D-700
610431	CHRY	61	Front	1992-92 1/2 D-600 & D-700
610432	FORD	60	Front	1993-93 1/2 F-350
610436	FORD	35	Front	1992 1/2 Ranger
610437	FORD	35	Front	1992 1/2 Explorer
610438	JEEP	30	Front	1993 ZJ ABS, CV Joint
610439	FORD	50	Front	1993-94 F-250 & F-350 (Snow Fighter)
610440	CHRY	60	Front	1994-94 1/2 W2500 HD
610443	FORD	44	Front	1994 Bronco w/ABS
610444	FORD	44	Front	1994 Bronco & F-150
610445	FORD	60	Front	1994 F-350
610446	FORD	44	Front	1995 Bronco & F-150
610447	FORD	44	Front	1994 Bronco w/ABS
610448	FORD	28	Front	1992 1/2-97 Aerostar
610449	JEEP	30	Front	1993 1/2 ZJ ABS DESCRIPTION 2
610450	JEEP	30	Front	1993 1/2 ZJ ABS DESCRIPTION 2
610451	JEEP	30	Front	1993 1/2 ZJ ABS DESCRIPTION 2
610452	JEEP	30	Front	1993 1/2 ZJ (Dead Front) w/ABS
610453	JEEP	30	Front	1994 XJ 4X2 (Dead Front)
610459	FORD	50	Front	1995 F-250 & F-350 (Snow Fighter)
610460	FORD	60	Front	1995 F-350
610461	JEEP	30	Front	1994-96 YJ Disconnect
610462	JEEP	30	Front	1994-96 YJ Disconnect w/ABS
610463	JEEP	30	Front	1994-96 YJ Non-Disconnect
610464	JEEP	30	Front	1994 YJ Disconnect
610465	JEEP	30	Front	1994 ZJ (Dead Front) w/ABS
610466	JEEP	30	Front	1994 XJ Non-Disconnect
610467	JEEP	30	Front	1994 XJ Non-Disconnect
610468	JEEP	30	Front	1994 XJ Non-Disconnect - Live Spindle Wheel End
610469	JEEP	30	Front	1994 XJ Non-Disconnect, ABS - Live Spindle
610472	JEEP	30	Front	1994 XJ 4X2 (Dead Front) w/ABS
610473	JEEP	30	Front	1994-96 ZJ ABS DESCRIPTION 2
610474	JEEP	30	Front	1994-94 1/2 ZJ ABS DESCRIPTION 2
610475	JEEP	30	Front	1994-97 ZJ (Dead Front) w/ABS

Bill of Material Number	Manufacturer	Model	Front / Rear	Application
610476	FORD	35	Front	1995 Explorer - Disconnect
610478	JEEP	30	Front	1994-96 ZJ ABS DESCRIPTION 2
610483	FORD	35	Front	1995-97 1/2 Ranger w/ABS
610484	FORD	28	Front	1995-97 1/2 Ranger w/ABS
610489	JEEP	30	Front	1997 TJ RHD
610500	JEEP	30	Front	1994 1/2-96 XJ 4X2 (Dead Front)
610501	JEEP	30	Front	1994 1/2-97 XJ 4X2 (Dead Front) w/ABS
610502	JEEP	30	Front	1994 1/2-97 XJ Non-Disconnect
610503	JEEP	30	Front	1994 1/2-97 XJ Non-Disconnect w/ABS
610504	JEEP	30	Front	1994 1/2-97 XJ RHD
610505	JEEP	30	Front	1994 1/2-97 XJ RHD w/ABS
610506	JEEP	30	Front	1994 1/2-97 XJ RHD, (Dead Front)
610507	JEEP	30	Front	1994 1/2-97 XJ RHD, (Dead Front)
610512	CHRY	44	Front	1995-96 1/2 W1500
610513	CHRY	44	Front	1995-96 1/2 W2500
610514	CHRY	44	Front	1995 W1500
610515	CHRY	44	Front	1995 W2500
610517	CHRY	60	Front	1995-96 W3500
610518	CHRY	60	Front	1995-96 W2500 HD
610528	JEEP	30	Front	1995-97 XJ Non-Disconnect w/ABS
610530	CHRY	60	Front	1995-96 1/2 D3500 (Dead Front)
610532	CHRY	60	Front	1995-96 Air Force Tow Vehicle
610537	CHRY	44	Front	1995-95 1/2 W1500
610538	CHRY	44	Front	1995-95 1/2 W2500
610539	CHRY	60	Front	1995-95 1/2 W2500 HD w/ABS
610540	CHRY	60	Front	1995-95 1/2 W3500
610541	CHRY	60	Front	1995 D3500 (Dead Front) w/ABS
610556	FORD	35	Front	1998 Explorer - Non-Disconnect - CV
610557	JEEP	30	Front	1995 1/2-97 XJ RHD
610558	JEEP	30	Front	1995-97 XJ Non-Disconnect w/ABS
610572	JEEP	30	Front	1996 1/2-97 1/2 ZJ w/ABS DESCRIPTION 3
610573	JEEP	30	Front	1996 1/2-97 1/2 ZJ w/ABS DESCRIPTION 3
610576	CHRY	35	Front	1997-99 DAKOTA
610581	FORD	35	Front	1995-96 Explorer - Disconnect- CV
610582	FORD	35	Front	1995-96 Explorer - Disconnect
610585	FORD	35	Front	1996 Explorer - Non-Disconnect - CV
610586	FORD	35	Front	1996 Explorer - Non-Disconnect
610602	CHRY	44	Front	1996 W1500
610603	CHRY	44	Front	1996 W2500
610604	CHRY	60	Front	1996 W2500 HD w/ABS
610605	CHRY	60	Front	1996 W3500
610606	CHRY	60	Front	1996 D3500 (Dead Front) w/ABS
610607	FORD	44	Front	1996 1/2 Bronco & F-150
610608	FORD	44	Front	1996 1/2 Bronco w/ABS
610609	FORD	50	Front	1996 1/2-97 F-250 & F-350 (Snow Fighter)
610610	FORD	60	Front	1996 1/2-97 F-350
610612	CHRY	44	Front	1996 W1500
610613	CHRY	44	Front	1996 W2500
610614	CHRY	44	Front	1996 1/2 W1500
610615	CHRY	44	Front	1996 1/2 W2500
610616	CHRY	60	Front	1996 1/2 W2500 HD
610617	CHRY	60	Front	1996 1/2 W2500 HD w/ABS
610618	CHRY	60	Front	1996 1/2 W3500

Bill of Material Numerical Listing

Bill of Material Number	Manufacturer	Model	Front / Rear	Application
610619	CHRY	60	Front	1996 1/2 W3500
610621	CHRY	60	Front	1996 D3500 (Dead Front) w/ABS
610622	CHRY	60	Front	1996 1/2 Air Force Tow Vehicle
610629	JEEP	30	Front	1997 TJ w/ABS
610630	JEEP	30	Front	1997 TJ
610631	CHRY	44	Front	1997-97 1/2 W1500
610632	CHRY	44	Front	1997-97 1/2 W2500
610633	CHRY	44	Front	1997-97 1/2 W1500
610634	CHRY	44	Front	1997-97 1/2 W2500
610635	CHRY	60	Front	1997 W2500 HD
610636	CHRY	60	Front	1997 W2500 HD w/ABS
610637	CHRY	60	Front	1997 W3500
610638	CHRY	60	Front	1997 W3500
610639	CHRY	60	Front	1997 D3500 (Dead Front)
610640	CHRY	60	Front	1997 D3500 (Dead Front) w/ABS
610642	FORD	35	Front	1998-98 1/2 Explorer/Ranger - Non-Disconnect - CV
610643	FORD	35	Front	1998-98 1/2 Explorer - Non-Disconnect
610644	FORD	35	Front	1997 1/2 Explorer - Non-Disconnect - CV
610645	FORD	35	Front	1998-98 1/2 Explorer - Non-Disconnect
610652	FORD	35	Front	1997-97 1/2 Ranger
610653	FORD	28	Front	1997 Ranger
610654	FORD	50	Front	1998 1/2-99 F-250/350 SRW (4x4) w/ABS
610659	FORD	50	Front	1998 1/2-99 F-250/350 SRW (4x4)
610663	JEEP	30	Front	1997-97 1/2 ZJ w/ABS DESCRIPTION 3
610664	JEEP	30	Front	1997-97 1/2 ZJ w/ABS DESCRIPTION 3
610665	JEEP	30	Front	1997-97 1/2 ZJ (Dead Front) w/ABS
610667	JEEP	30	Front	1997 1/2 XJ 4X2 (Dead Front)
610668	JEEP	30	Front	1997 1/2 XJ 4X2 (Dead Front) w/ABS
610669	JEEP	30	Front	1997 1/2 XJ 4X2 (Dead Front)
610670	JEEP	30	Front	1997 1/2 XJ 4X2 (Dead Front) w/ABS
610671	JEEP	30	Front	1997 XJ Non-Disconnect - Live Spindle Wheel End
610672	JEEP	30	Front	1997 1/2 XJ Non-Disconnect, ABS - Live Spindle
610673	JEEP	30	Front	1997 1/2 XJ Non-Disconnect - Live Spindle Wheel End
610674	JEEP	30	Front	1997 1/2 XJ Non-Disconnect, ABS - Live Spindle
610675	JEEP	30	Front	1997 1/2 XJ Diesel
610676	JEEP	30	Front	1997 1/2 XJ Diesel w/ABS
610677	JEEP	30	Front	1997 1/2 XJ Diesel
610678	JEEP	30	Front	1997 1/2 XJ Diesel w/ABS
610680	JEEP	30	Front	1997 1/2 TJ RHD
610681	JEEP	30	Front	1997 1/2 TJ w/ABS
610682	JEEP	30	Front	1997 1/2 TJ
610708	CHRY	60	Front	1997 W2500 HD
610714	CHRY	60	Front	1997 1/2 Air Force Tow Vehicle
610715	CHRY	44	Front	1998-98 1/2 W1500
610717	CHRY	44	Front	1998-98 1/2 W1500
610719	CHRY	60	Front	1998-98 1/2 W2500 HD
610720	CHRY	60	Front	1998-98 1/2 W3500
610722	CHRY	60	Front	1998-98 1/2 W3500
610723	CHRY	60	Front	1998-98 1/2 W3500
610724	CHRY	60	Front	1998 D3500 (Dead Front)
610725	CHRY	60	Front	1998 D3500 (Dead Front) w/ABS
610727	CHRY	60	Front	1997 W2500 HD
610728	CHRY	60	Front	1997 W2500 HD w/ABS

Bill of Material Number	Manufacturer	Model	Front / Rear	Application
610729	CHRY	60	Front	1997 1/2 W3500
610730	CHRY	60	Front	1997 1/2 W3500
610731	CHRY	60	Front	1997 D3500 (Dead Front)
610732	CHRY	60	Front	1997 D3500 (Dead Front) w/ABS
610738	CHRY	60	Front	1997 1/2 W2500 HD
610739	CHRY	60	Front	1997 1/2 W2500 HD w/ABS
610740	FORD	50	Front	1997 1/2-98 F-250 & F-350 (Snow Fighter)
610741	FORD	60	Front	1997 1/2-98 F-350
610745	CHRY	60	Front	1997 W2500 HD
610746	CHRY	60	Front	1997 W2500 HD w/ABS
610748	JEEP	30	Front	1998-98 1/2 ZJ w/ABS DESCRIPTION 3
610749	JEEP	30	Front	1998-98 1/2 ZJ ABS, CV Joint
610750	JEEP	30	Front	1998-98 1/2 ZJ (Dead Front) w/ABS
610751	JEEP	30	Front	1998-98 1/2 ZJ ABS, CV Joint
610752	JEEP	30	Front	1998-98 1/2 ZJ w/ABS DESCRIPTION 3
610755	JEEP	30	Front	1998-98 1/2 TJ
610756	JEEP	30	Front	1998-98 1/2 TJ w/ABS
610757	JEEP	30	Front	1998-98 1/2 TJ RHD
610758	JEEP	30	Front	1998-98 1/2 XJ Non-Disconnect, Cardan - Live Spindle Wheel End
610759	JEEP	30	Front	1998-98 1/2 XJ Non-Disconnect, ABS - Live Spindle
610760	JEEP	30	Front	1998-98 1/2 XJ Non-Disconnect - Live Spindle Wheel End
610761	JEEP	30	Front	1998-98 1/2 XJ Non-Disconnect, ABS - Live Spindle
610762	JEEP	30	Front	1998-98 1/2 XJ Diesel
610763	JEEP	30	Front	1998-98 1/2 XJ Diesel w/ABS
610764	JEEP	30	Front	1998-98 1/2 XJ Diesel
610765	JEEP	30	Front	1998-98 1/2 XJ Diesel w/ABS
610766	JEEP	30	Front	1998-98 1/2 XJ 4X2 (Dead Front)
610767	JEEP	30	Front	1998-98 1/2 XJ 4X2 (Dead Front) w/ABS
610768	JEEP	30	Front	1998-98 1/2 XJ 4X2 (Dead Front)
610769	JEEP	30	Front	1998-98 1/2 XJ 4X2 (Dead Front) w/ABS
610792	CHRY	44	Front	1998 1/2 W1500
610793	CHRY	44	Front	1998 1/2 W1500
610808	CHRY	60	Front	1998 W2500 HD
610809	CHRY	60	Front	1998 1/2 W3500
610810	CHRY	60	Front	1998 W2500 HD w/ABS
610811	CHRY	60	Front	1998 1/2 W3500
610812	CHRY	60	Front	1998 D3500 (Dead Front)
610813	CHRY	60	Front	1998 D3500 (Dead Front) w/ABS
610814	CHRY	44	Front	1998 W1500
610815	CHRY	44	Front	1998 W1500
610849	JEEP	30	Front	1998 X1 Non-Disconnect
610850	JEEP	30	Front	1998 X1 Non-Disconnect w/ABS
610851	JEEP	30	Front	1998 X1 Non-Disconnect, RH Steering
610852	JEEP	30	Front	1998 X1 Non-Disconnect, RH Steering w/ABS
610853	JEEP	30	Front	1998 X1 Non-Disconnect, Diesel w/ABS
610854	JEEP	30	Front	1998 X1 (Dead Front)
610855	JEEP	30	Front	1998 X1 (Dead Front) w/ABS

Dodge / Chrysler 1997-1999

Model 35 /194 IFS Front Axles for

Dakota
Durango

Dodge Model 35 /194 IFS Front Axles Exploded View

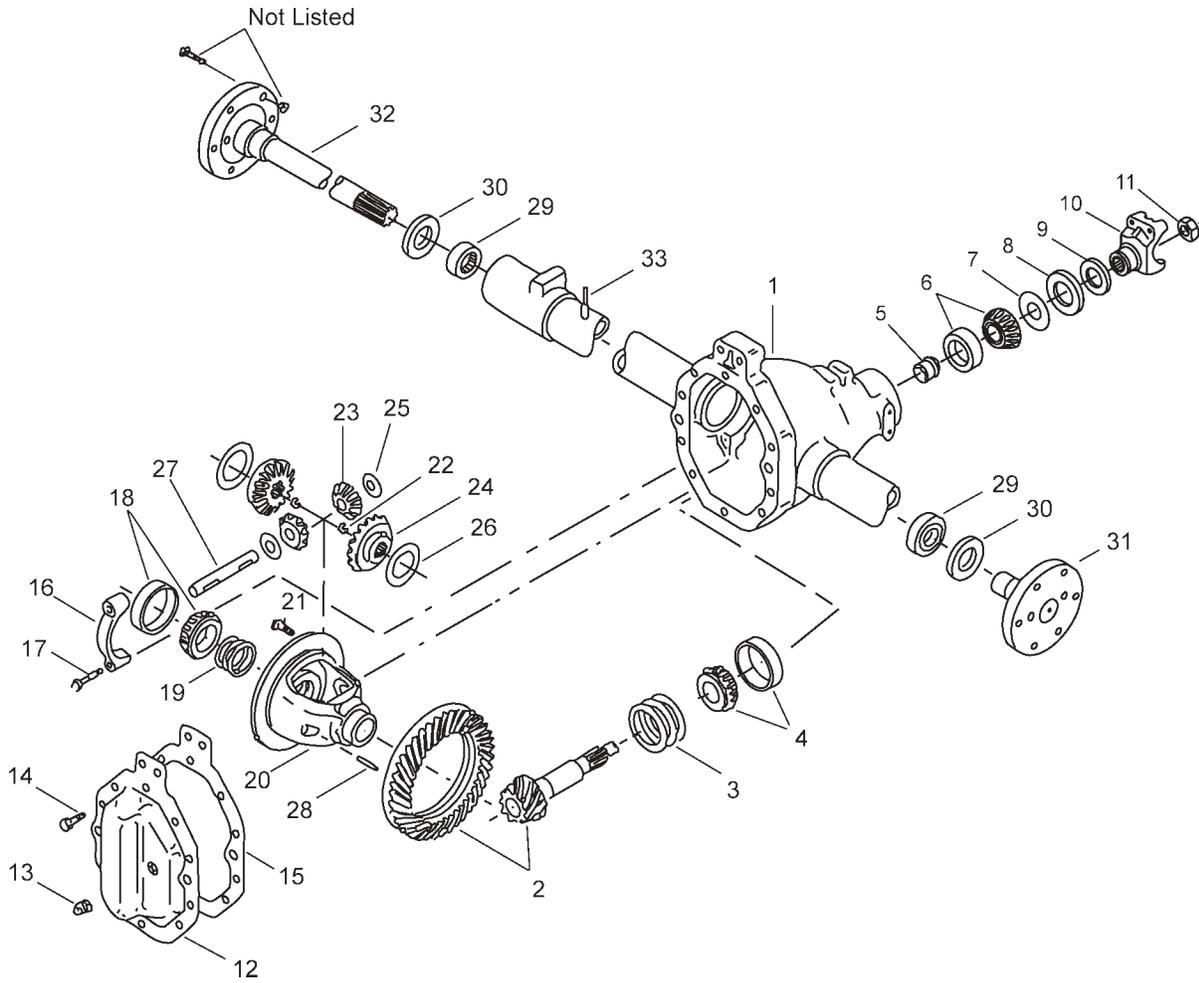

Dodge Model 35 /194 IFS Front Axles Parts Listing

ITEM NO.	PART NUMBER	DESCRIPTION	ITEM NO.	PART NUMBER	DESCRIPTION
1	— ⁽³⁾	Housing – Axle Service	17	40284-1	Bolt – Differential Bearing Cap
2	— ⁽¹⁾	Drive Pinion & Gear Assembly	18	706016X	KIT – Differential Bearing
3	701130X	PKG – Inner Pinion Shim	19	701004X	PKG – Differential Bearing Shim
4	707162X	KIT – Inner Pinion Bearing	20	— ⁽¹⁾	Case – Differential
5	42102	Collapsible Spacer	21	41221	Bolt – Drive Gear (qty 10)
6	706894X	KIT – Outer Pinion Bearing	22	42570	Snap Ring
7	42778	Slinger – Outer Pinion Bearing	23	46504	Pinion – Differential
8	48009	Seal – Pinion Oil	24	47559	Gear – Differential
9	48008	Seal – End Yoke	25	34096	Thrustwasher – Differential Pinion
10	2-4-8131-1	End Yoke	26	34095	Thrustwasher – Differential Gear
11	44189	Pinion Nut	27	41648	Shaft – Differential Pinion
	707438X	KIT – Carrier Cover	28	13449	Lock – Differential Shaft
12	— ⁽⁴⁾	Carrier Cover	29	565977	Bearing
13	41356	Plug – Carrier Cover	30	46485	Oil Seal
14	40286-5	Bolt – Carrier Cover (qty 10)	31	47067	Shaft – Axle (LH)
15	38615	RTV Silicone Sealant	32	47065	Shaft – Axle (RH)
16	— ⁽³⁾	Differential Bearing Cap	33	41962	Vent – Axle Shaft (RH)

(1) See "Bill of Material Table" Below

(3) Contact Vehicle Manufacturer

(4) Not Sold Separately

Bill of Material Table

Axle			Axle Kits				Shaft & Joint Assy.	
Bill of Material	Diff. Type	Ratio	Ring Gear & Pinion Kit ⁽⁷⁾	Differential			Right Hand Shaft Assy.	Left Hand Shaft Assy.
				Case Assy. Kit ⁽⁸⁾	Case Kit	Inner Parts Kit		
1997-99 DAKOTA								
610576-1	Standard	3.21	75812-5X	75935X	47071	707436X	—	—
610576-2	Standard	3.55	74346-5X	75934X	47069	707436X	—	—
610576-3	Standard	3.92	75813-5X	75934X	47069	707436X	—	—
1997-99 DURANGO								
610576-4	Standard	3.21	75812-5X	75935X	47071	707436X	—	—
610576-5	Standard	3.55	74346-5X	75934X	47069	707436X	—	—
610576-6	Standard	3.92	75813-5X	75934X	47069	707436X	—	—

(7) See Ring Gear & Pinion Kits in XGI Catalog for ratio & tooth combinations.

(8) See Differential Case Assy Kits in XGI Catalog for spline data & ratios.

Dodge / Chrysler 1979-1989

Model 44 /216 Front Axles for

D-600 (Export)

W-100, W-200

Dodge Model 44 /216 Front Axles Exploded View

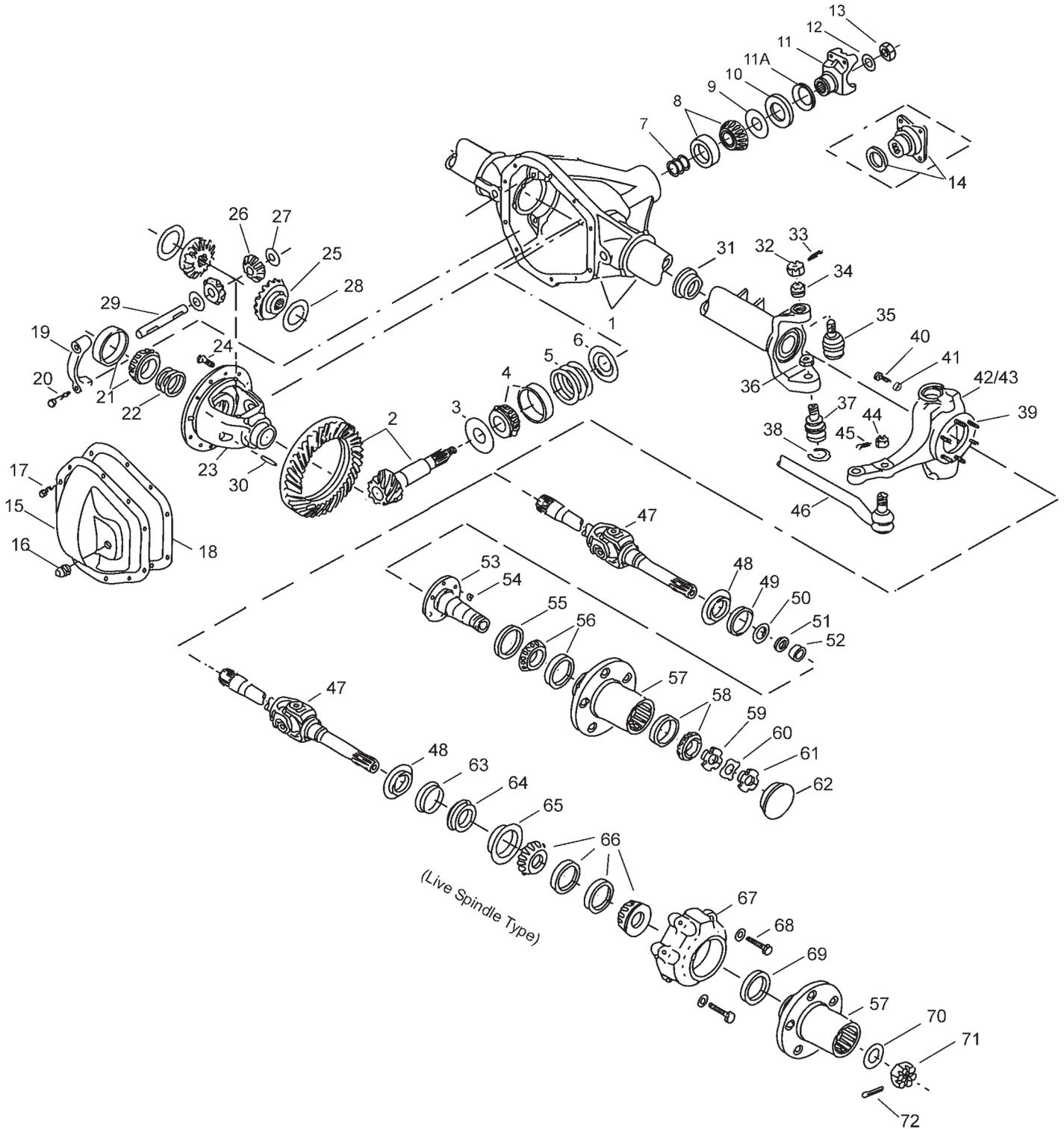

Dodge Model 44 /216 Front Axles

Parts Listing

ITEM NO.	PART NUMBER	DESCRIPTION	ITEM NO.	PART NUMBER	DESCRIPTION
1	— ⁽³⁾	Housing – Axle Service	36	35566	Lock Nut
2	— ⁽¹⁾	Drive Pinion & Gear Assembly	37	40113	Socket Assembly – Lower
3	30764	Slinger – Inner Pinion Bearing	38	35928	Snap Ring
4	706031X	KIT – Inner Pinion Bearing	39	36326-1	Bolt – Hex (qty 6)
	706376X	PKG – Diff & Pinion Bearing Shim (inc items 5, 7, 12, 13, 18, 22)	40	620143-3	Stop Screw
	706358X	PKG – Pinion Bearing Shim (inc items 5, 7, 12, 13, 18)	41	500381-5	Jam Nut
5	— ⁽⁴⁾	Inner Pinion Shims (see shim packages)	42	— ⁽³⁾	Right Knuckle
6	30765	Baffle – Pinion Bearing	43	— ⁽³⁾	Left Knuckle
7	— ⁽⁴⁾	Outer Pinion Shims (see shim packages)	44	— ⁽⁵⁾	Nut – Hex Slotted
8	706030X	KIT – Outer Pinion Bearing	45	— ⁽⁵⁾	Cotter Pin
9	13575	Slinger – Outer Pinion Bearing	46	— ⁽⁵⁾	Tie Rod Assembly
10	39118	Seal – Pinion Oil	47	706184X	KIT – Steering Arm
11	— ⁽³⁾	End Yoke Assembly (inc 11A)	48	— ⁽¹⁾	Shaft & Joint Assembly
11A	— ⁽³⁾	Slinger – End Yoke		— ⁽²⁾	Slinger – Spindle Yoke
12	30186	Washer – Pinion Nut	49	38128	KIT – Spindle Seal & Bearing (inc items 49, 50, 51, 52)
13	30185	Pinion Nut	50	36361	Oil Seal
14	—	Companion Flange Assembly	51	38106	Oil Seal (block-vee)
	— ⁽²⁾	KIT – Carrier Cover (inc items 15, 16, 17, 18)	52	550759	Spacer – Wheel Bearing Spindle
15	— ⁽²⁾	Carrier Cover	53	— ⁽²⁾	Needle Bearing Assembly
16	36472	Plug – Carrier Cover	54	35704	Spindle – Wheel Bearing
17	34279	Bolt – Carrier Cover	55	36366	Brake Mounting Nut
18	34685	Gasket – Carrier Cover	56	706690X	Oil Seal
19	— ⁽³⁾	Differential Bearing Cap	57	— ⁽³⁾	KIT – Inner Wheel Bearing
20	48632-1	Bolt – Differential Bearing Cap	58	706111X	Wheel Hub
21	706032X	KIT – Differential Bearing	59	21588X	KIT – Outer Wheel Bearing
22	706086X	PKG – Diff Bearing Shim (inc 18)	60	— ⁽²⁾	Nut & Pin Assembly – Inner Lock
23	— ⁽¹⁾	Case – Differential	61	31139	Lock Nut
24	30187	Bolt – Drive Gear (qty 10)	62	44328	Nut – Wheel Bearing Adjusting
25	31487	Gear – Differential	63	36999	Hub Cap
26	17717	Pinion – Differential	64	38415	Brake Dust Shield
27	13338-3	Thrustwasher – Differential Pinion	65	38416	Oil Seal
28	32121	Thrustwasher – Differential Gear	66	565963	U-Cup Seal
29	39194	Shaft – Differential	67	29908X	Bearing Assembly
30	13449	Lock – Differential Shaft	68	37709	Wheel Bearing Retainer Assembly
31	— ⁽²⁾	Seal & Guide Tube	69	37003	Screw - Flange Head
	706116X	KIT – Socket Assembly (inc items 32,33,34,35,36,37,38)	70	30186-2	Oil Seal
32	44101	Nut – Hex Slotted	71	46085	Shaft Nut Washer
33	500024-6	Cotter Pin	72	500025-11	Slotted Nut
34	35417	Adjusting Split Ring		706555X	Cotter Pin
35	40112	Socket Assembly – Upper		706554X	KIT – Wheel End (Live Spindle) (inc items 48, 64, 65, 66, 69)
					KIT – Wheel End Brg (Live Spindle) (inc items 48, 64, 65, 66, 67)

(1) See "Bill of Material Table" on next page

(2) See "Variable Parts Table" within this section

(3) Contact Vehicle Manufacturer

(4) Not Sold Separately

(5) See Spicer Chassis Catalog for part number and additional steering parts

Dodge Model 44 /216 Front Axles

Bill of Material Table

Axle			Axle Kits				Shaft & Joint Assy.	
Bill of Material	Diff. Type	Ratio	Ring Gear & Pinion Kit ⁽⁷⁾	Differential			Right Hand Shaft Assy.	Left Hand Shaft Assy.
				Case Assy. Kit ⁽⁸⁾	Case Kit	Inner Parts Kit		
1979 W-100								
610027-1	Standard	3.23	706017-16X	706020X	706024X	706027X	28478-1X	28478-2X
610027-2	Standard	3.54	706017-3X	706020X	706024X	706027X	28478-1X	28478-2X
610027-3	Standard	3.92	706017-11X	706021X	706025X	706027X	28478-1X	28478-2X
1979 W-200								
610028-1	Standard	4.09	706017-5X	706021X	706025X	706027X	28478-3X	28478-4X
610028-2	Standard	3.54	706017-3X	706020X	706024X	706027X	28478-3X	28478-4X
1980 W-100								
610076-5	Standard	2.94	700025-7	706020X	706024X	706027X	660599-1	660599-2
610076-6	Standard	3.23	706017-16X	706020X	706024X	706027X	660599-1	660599-2
610076-7	Standard	3.54	706017-3X	706020X	706024X	706027X	660599-1	660599-2
610076-8	Standard	2.72	706017-19X	706020X	706024X	706027X	660599-1	660599-2
610076-9	Standard	2.94	700025-7	706020X	706024X	706027X	660599-1	660599-2
610076-10	Standard	3.23	706017-16X	706020X	706024X	706027X	660599-1	660599-2
610076-11	Standard	3.54	706017-3X	706020X	706024X	706027X	660599-1	660599-2
1980 W-200								
610077-3	Standard	3.54	706017-3X	706020X	706024X	706027X	660599-3	660599-4
610077-4	Standard	4.09	706017-5X	706021X	706025X	706027X	660599-3	660599-4
610077-5	Standard	3.54	706017-3X	706020X	706024X	706027X	660599-3	660599-4
610077-6	Standard	4.09	706017-5X	706021X	706025X	706027X	660599-3	660599-4
1980-83 W-200 (Dead Front)								
610084	-	-	-	-	-	-	-	-
1981-84 W-100								
610127-1	Standard	2.94	700025-7	706020X	706024X	706027X	660599-1	660599-2
610127-2	Standard	3.23	706017-16X	706020X	706024X	706027X	660599-1	660599-2
610127-3	Standard	3.54	706017-3X	706020X	706024X	706027X	660599-1	660599-2
1981-84 W-200								
610128-1	Standard	3.54	706017-3X	706020X	706024X	706027X	660599-3	660599-4
610128-2	Standard	4.09	706017-5X	706021X	706025X	706027X	660599-3	660599-4
1985-89 D-600 (Export)								
610160-1	Standard	3.92	706017-11X	706021X	706025X	706027X	71628-1X	71628-2X
610160-2	Standard	3.54	706017-3X	706020X	706024X	706027X	71628-1X	71628-2X
610160-3	Standard	3.23	706017-16X	706020X	706024X	706027X	71628-1X	71628-2X

(7) See Ring Gear & Pinion Kits in XGI Catalog for ratio & tooth combinations.

(8) See Differential Case Assy Kits in XGI Catalog for spline data & ratios.

Variable Parts Listing

Kits & Parts - Use With All Applications								
Description & Item Number (Refer to "Exploded View")			Bills of Material					
			610027 610028	610076 610077	610084	610127 610128	610160	
1	KIT – Carrier Cover	-	700107	700107	700107	700107	700107	706154X
2	Carrier Cover	15	620417	620417	620417	620417	620417	620222
3	Seal & Guide Tube	31	620216	620216	—	620216	620216	620216
4	Slinger – Spindle Yoke	48	38414	36364	36364	36364	36364	36364
5	KIT – Spindle	-	—	—	—	706570X	706560X	
6	Spindle – Wheel Bearing	53	—	38452	38428	38428	38428	
7	Lock Nut	60	—	39909	36569	39909	39909	—

Dodge / Chrysler 1985-1993 1/2

**Model 44 /216 Disconnect
Front Axles for**

D-500, D-600, D-800

Dodge Model 44 /216 Disconnect Front Axles Exploded View

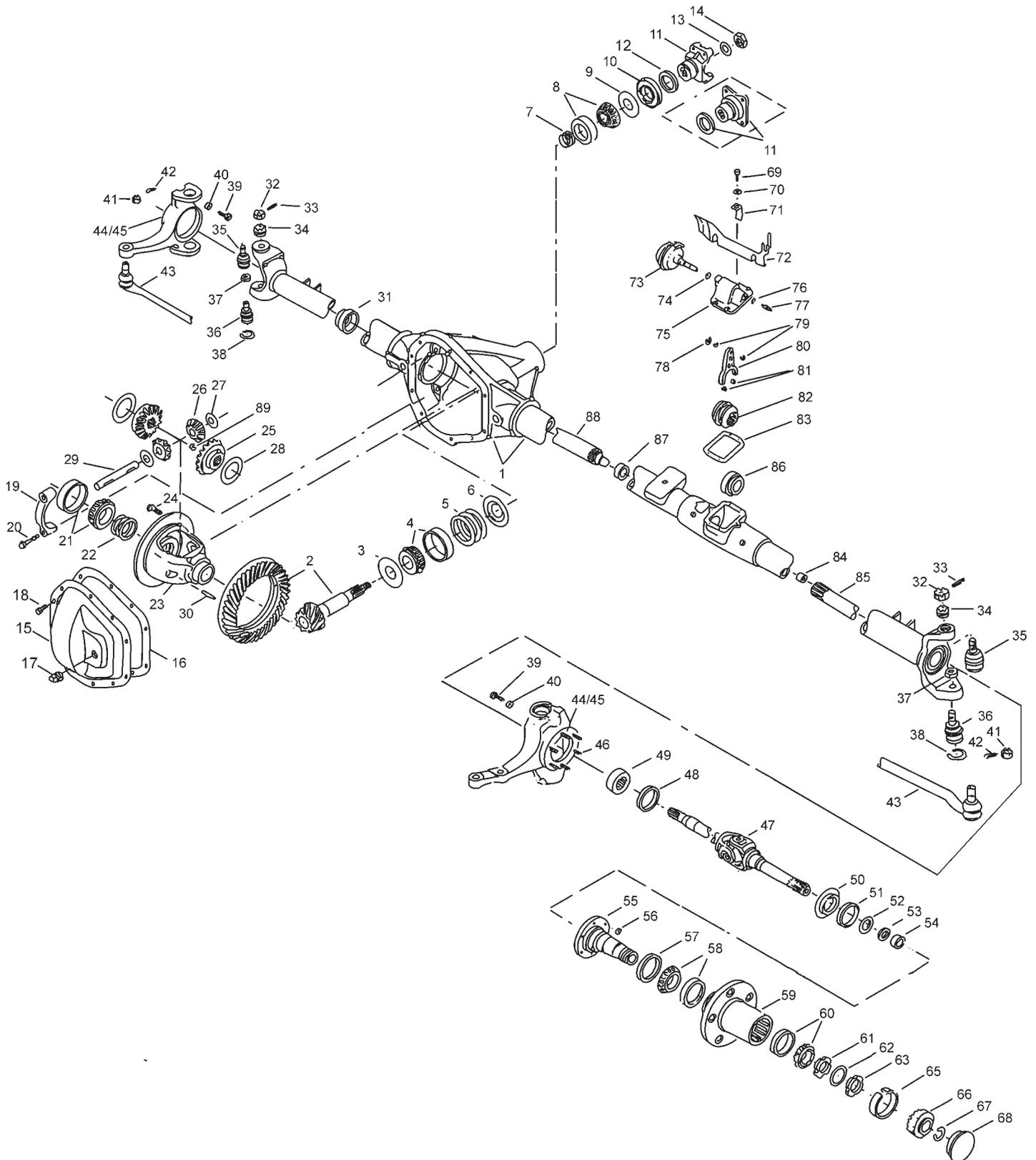

Dodge Model 44 /216 Disconnect Front Axles

Parts Listing

ITEM NO.	PART NUMBER	DESCRIPTION	ITEM NO.	PART NUMBER	DESCRIPTION
1	— ⁽³⁾	Housing – Axle Service	44	— ⁽³⁾	Right Knuckle
2	— ⁽¹⁾	Drive Pinion & Gear Assembly	45	— ⁽³⁾	Left Knuckle
3	30764	Slinger – Inner Pinion Bearing	46	36326-1	Bolt – Knuckle
4	706031X	KIT – Inner Pinion Bearing	47	— ⁽¹⁾	Shaft & Joint Assembly
	706358X	PKG – Pinion Bearing Shim (inc items 5, 7, 12, 13, 16)	48	— ⁽²⁾	Oil Seal (left side)
	706376X	PKG – Diff & Pinion Bearing Shim (inc items 5, 7, 12, 13, 16, 22)	49	— ⁽²⁾	Bearing (left side)
5	— ⁽⁴⁾	Inner Pinion Shims (see shim packages)	50	36364	Slinger – Outer Shaft
6	30765	Baffle - Pinion Bearing		706570X	KIT – Spindle (RH, inc items 51-55)
7	— ⁽⁴⁾	Outer Pinion Shims (see shim packages)		— ⁽²⁾	KIT – Spindle (LH, inc items 51-55)
8	706030X	KIT – Outer Pinion Bearing	51	38128	KIT – Spindle Seal & Bearing (inc items 51, 52, 53, 54)
9	13575	Slinger – Outer Pinion Bearing	52	36361	Oil Seal
10	39118	Seal – Pinion Oil	53	38106	Oil Seal (block-vee)
11	— ⁽³⁾	End Yoke/Companion Flange	54	550759	Spacer – Wheel Bearing Spindle
12	— ⁽³⁾	Slinger – End Yoke	55	— ⁽²⁾	Needle Bearing Assembly
13	30186	Washer – Pinion Nut	56	38428	Oil Seal Retainer
14	30185	Pinion Nut	57	35704	Spindle
	707014X	KIT – Carrier Cover (inc 15,16,17,18)	58	40709	Brake Mounting Nut
15	41545	Cover & Clip Assembly – Carrier	59	— ⁽³⁾	Oil Seal
16	34685	Gasket – Carrier Cover	60	— ⁽³⁾	KIT – Inner Wheel Bearing
	38615	RTV Silicone Sealant	61	21588X	Wheel Hub
17	36472	Plug – Carrier Cover	62	36569	KIT – Outer Wheel Bearing
18	34279	Bolt – Carrier Cover (qty 10)	63	31139	Nut & Pin Assembly
19	— ⁽³⁾	Differential Bearing Cap	64	— ⁽²⁾	Lock Nut
20	48632-1	Bolt – Differential Bearing Cap	65	42667	Nut – Wheel Bearing Adjusting
21	706032X	KIT – Differential Bearing	66	31624	Spacer – Drive Gear
22	706086X	PKG – Diff Bearing Shim (inc 16)	67	44328	Axle Drive Gear
23	— ⁽¹⁾	Case – Differential	68	500396-10	Snap Ring
24	41221	Bolt – Drive Gear (qty 10)	69	500357-9	Hub Cap
25	40194	Gear – Differential	70	41594	Cap Screw
26	17717	Pinion – Differential	71	42206	Lockwasher
27	13338-3	Thrustwasher – Differential Pinion	72	— ⁽²⁾	Brake Line Clip
28	40196	Thrustwasher – Differential Gear	73	620980	Protection Shield
29	39194	Shaft – Differential	74	42208	Motor Assembly
30	13449	Lock – Differential Shaft	75	44476	O-Ring
31	620216	Seal – Tube (right side)	76	— ⁽²⁾	Cover – Disconnect Housing
	706116X	KIT – Socket Assembly (inc 32, 33, 34, 35, 36, 37, 38)	77	621097	O-Ring
32	44101	Nut – Hex Slotted	78	620979	Switch Assembly
33	500024-6	Cotter Pin	79	41553	Snap Ring
34	35417	Adjusting Split Ring	80	— ⁽²⁾	Snap Ring
35	40112	Socket Assembly – Upper	81	621059	Shift Fork
36	40113	Socket Assembly – Lower	82	42998	KIT – Cover and Motor Assembly (inc 73, 74, 75, 76, 77, 78, 79, 80)
37	35566	Lock Nut		706824X	Clip – Shift Fork
38	35928	Snap Ring	83	41494	Clutch Collar
39	— ⁽²⁾	Stop Screw	84	565985	KIT – Shift Clip (inc 69, 70, 81, 83)
40	500381-3	Jam Nut	85	— ⁽²⁾	Gasket
41	— ⁽⁵⁾	Nut – Hex Slotted	86	— ⁽²⁾	Bushing / Bearing
42	— ⁽⁵⁾	Cotter Pin	87	566008	Inner Yoke Shaft (left side)
43	— ⁽⁵⁾	Tie Rod Assembly	88	75265X	Seal – Tube (left side)
	— ⁽²⁾	KIT – Steering Arm	89	42570	Bushing / Bearing
					KIT – Axle Shaft (output)
					Snap Ring – Inner Shaft (if required)

(1) See "Bill of Material Table" on next page

(2) See "Variable Parts Table" within this section

(3) Contact Vehicle Manufacturer

(4) Not Sold Separately

(5) See Spicer Chassis Catalog for part number and additional steering parts

Dodge Model 44 /216 Disconnect Front Axles

Bill of Material Table

Axle			Axle Kits				Shaft & Joint Assy.	
Bill of Material	Diff. Type	Ratio	Ring Gear & Pinion Kit ⁽⁷⁾	Differential			Right Hand Shaft Assy.	Left Hand Shaft Assy.
				Case Assy. Kit ⁽⁸⁾	Case Kit	Inner Parts Kit		
1985-86 D-500 & D-800								
610216-2	Standard	3.23	707020-2X	707021X	707023X	707025X	660599-1	72467-1X
610216-3	Standard	3.54	707020-3X	707021X	707023X	707025X	660599-1	72467-1X
1985-86 D-600								
610217-1	Standard	3.54	707020-3X	707021X	707023X	707025X	660599-3	72467-2X
610217-2	Standard	4.09	707020-4X	707022X	707024X	707025X	660599-3	72467-2X
1986-87 1/2 D-600								
610258-1	Standard	3.54	707020-3X	707021X	707023X	707025X	660599-3	72467-2X
610258-2	Standard	4.09	707020-4X	707022X	707024X	707025X	660599-3	72467-2X
1986 1/2-87 1/2 D-500 & D-800								
610257-1	Standard	3.23	707020-2X	707021X	707023X	707025X	660599-1	72467-1X
610257-2	Standard	3.54	707020-3X	707021X	707023X	707025X	660599-1	72467-1X
1988-88 1/2 D-500 & D-800								
610277-1	Standard	3.23	707020-2X	707021X	707023X	707025X	660599-1	73578-1X
610277-2	Standard	3.54	707020-3X	707021X	707023X	707025X	660599-1	73578-1X
610329-1	Standard	3.23	707020-2X	707021X	707023X	707025X	660599-1	73578-1X
610329-2	Standard	3.54	707020-3X	707021X	707023X	707025X	660599-1	73578-1X
610329-3	Standard	3.92	707020-5X	707022X	707024X	707025X	660599-1	73578-1X
1988-88 1/2 D-600								
610278-1	Standard	3.54	707020-3X	707021X	707023X	707025X	660599-3	73578-2X
610278-2	Standard	4.09	707020-4X	707022X	707024X	707025X	660599-3	73578-2X
1989-90 D-600								
610331-1	Standard	3.54	707020-3X	707021X	707023X	707025X	660599-3	73578-2X
610331-2	Standard	4.09	707020-4X	707022X	707024X	707025X	660599-3	73578-2X
610331-3	Standard	3.92	707020-5X	707022X	707024X	707025X	660599-3	73578-2X
1990-91 1/2 D-500 & D-800								
610355-1	Standard	3.23	707020-2X	707021X	707023X	707025X	660599-1	73578-1X
610355-2	Standard	3.54	707020-3X	707021X	707023X	707025X	660599-1	73578-1X
610355-3	Standard	3.92	707020-5X	707022X	707024X	707025X	660599-1	73578-1X
1991-91 1/2 D-600								
610356-1	Standard	3.54	707020-3X	707021X	707023X	707025X	660599-3	73578-2X
610356-2	Standard	4.09	707020-4X	707022X	707024X	707025X	660599-3	73578-2X
610356-3	Standard	3.92	707020-5X	707022X	707024X	707025X	660599-3	73578-2X
610360-2	Standard	3.54	707020-3X	707021X	707023X	707025X	74236-1X	74225-1X
1992-93 1/2 D-600 & D-800								
610270-1	Standard	3.23	707020-2X	707021X	707023X	707025X	660599-1	73578-1X
610270-2	Standard	3.54	707020-3X	707021X	707023X	707025X	660599-1	73578-1X
610270-3	Standard	3.92	707020-5X	707022X	707024X	707025X	660599-1	73578-1X
1992-93 1/2 D-600								
610271-1	Standard	3.54	707020-3X	707021X	707023X	707025X	660599-3	73578-2X
610271-2	Standard	4.09	707020-4X	707022X	707024X	707025X	660599-3	73578-2X
610271-3	Standard	3.92	707020-5X	707022X	707024X	707025X	660599-3	73578-2X

(7) See Ring Gear & Pinion Kits in XGI Catalog for ratio & tooth combinations.

(8) See Differential Case Assy Kits in XGI Catalog for spline data & ratios.

Dodge Model 44 /216 Disconnect Front Axles

Variable Parts Listing

Kits & Parts - Use With All Applications							
Description & Item Number (Refer to "Exploded View" at the front of this section)			Bills of Material				
			610216	610217	610257	610258	610270
1	Stop Screw	39	31026-1	31026-1	31026-2	31026-2	620143-2
2	KIT – Steering Arm	-	706184X	706184X	706184X	706184X	707265X
3	Oil Seal (left side)	48	40191	40191	40191	40191	—
4	Bearing (left side)	49	565983	565983	565983	565983	—
5	KIT – Spindle (LH, inc items 51-55)	-	707013X ⁽⁹⁾	707013X ⁽⁹⁾	707013X ⁽⁹⁾	707013X ⁽⁹⁾	706570X
6	Oil Seal Retainer	-	40608	40608	40608	40608	—
7	Spacer – Drive Gear	65	41606	41606	41606	41606	41606
8	Motor Assembly	73	41330	41330	41330	41330	43429
9	Switch Assembly	77	41378	41378	41378	41378	42742
10	KIT – Cover and Motor Assembly	-	73004X	73004X	73004X	73004X	73764X
11	Inner Yoke Shaft (left side)	85	72706-3X	72706-4X	72706-3X	72706-4X	73579-1X
12	Seal – Tube (left side)	86	—	—	—	—	43154
			610271	610277	610278	610329	610331
1	Stop Screw	39	620143	31026-2	31026-2	31026-2	31026-2
2	KIT – Steering Arm	-	707265X	706184X	706184X	706184X	706184X
3	Oil Seal (left side)	48	—	—	—	—	—
4	Bearing (left side)	49	—	—	—	—	—
5	KIT – Spindle (LH, inc items 51-55)	-	706570X	706570X	706570X	706570X	706570X
6	Oil Seal Retainer	-	—	—	—	—	—
7	Spacer – Drive Gear	65	41606	41606	41606	41606	41606
8	Motor Assembly	73	43429	41330	41330	43429	43429
9	Switch Assembly	77	42742	42742	42742	42742	42742
10	KIT – Cover and Motor Assembly	-	73764X	73540X	73540X	73764X	73764X
11	Inner Yoke Shaft (left side)	85	73579-2X	73579-1X	73579-2X	73579-1X	73579-2X
12	Seal – Tube (left side)	86	43154	43154	43154	43154	43154
			610355	610356	610360		
1	Stop Screw	39	620143-2	620143-2	31026-2		
2	KIT – Steering Arm	-	706184X	706184X	706850X		
3	Oil Seal (left side)	48	—	—	—		
4	Bearing (left side)	49	—	—	—		
5	KIT – Spindle (LH, inc items 51-55)	-	706570X	706570X	706570X		
6	Oil Seal Retainer	-	—	—	—		
7	Spacer – Drive Gear	65	41606	41606	—		
8	Motor Assembly	73	43429	43429	43429		
9	Switch Assembly	77	42742	42742	42742		
10	KIT – Cover and Motor Assembly	-	73764X	73764X	73764X		
11	Inner Yoke Shaft (left side)	85	73579-1X	73579-2X	72706-1X		
12	Seal – Tube (left side)	86	43154	43154	43154		

(9) 707013X uses an oil seal retainer instead of a needle bearing.

Dodge / Chrysler 1994-1998 1/2

**Model 44 /216 Disconnect Front
Axles for**

W1500 and W2500 Ram

Dodge Model 44 /216 Disconnect Front-Ram Exploded View

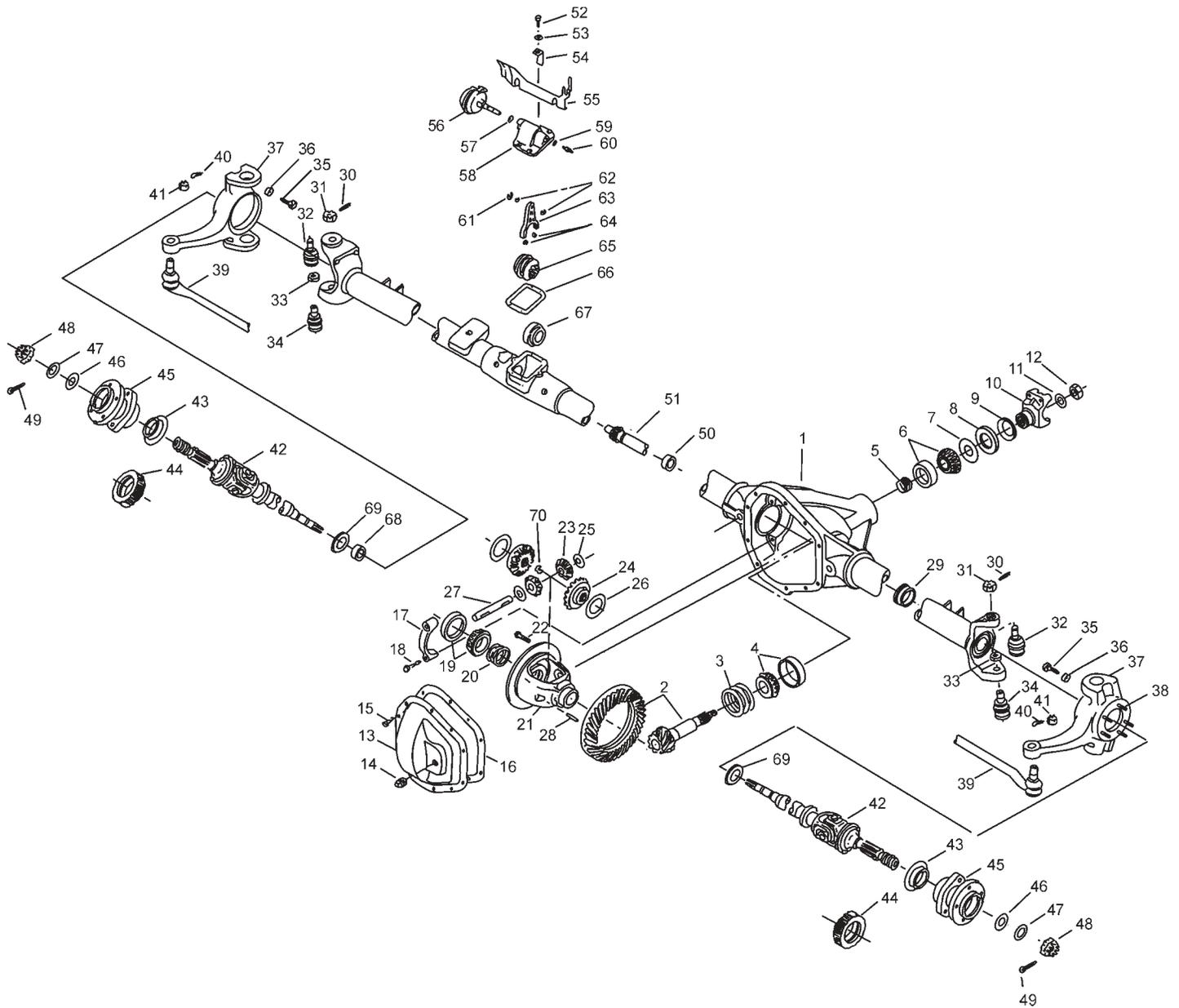

Dodge Model 44 /216 Disconnect Front-Ram Parts Listing

ITEM NO.	PART NUMBER	DESCRIPTION	ITEM NO.	PART NUMBER	DESCRIPTION
1	— ⁽³⁾	Housing – Axle Service	37	— ⁽³⁾	Knuckle (RH)
2	— ⁽¹⁾	Drive Pinion & Gear Assembly		— ⁽³⁾	Knuckle (LH)
3	701112X	PKG – Inner Pinion Shim	38	44993-1	Bolt – Knuckle (if required)
4	706015X	KIT – Inner Pinion Bearing	39	— ⁽⁵⁾	Tie Rod Assembly
5	44896	Collapsible Spacer	40	— ⁽⁵⁾	Cotter Pin
6	706030X	KIT – Outer Pinion Bearing	41	— ⁽⁵⁾	Nut – Slotted
7	13575	Slinger – Outer Pinion Bearing	42	— ⁽¹⁾	Shaft & Joint Assembly
8	44895	Seal – Pinion Oil	43	— ⁽²⁾	Slinger
9	232549	Seal – End Yoke		— ⁽²⁾	Shaft & Slinger Assembly
10	2-4-7651-1X	End Yoke Assembly (inc 9)	44	— ⁽²⁾	Shaft & Tone Ring Assy (ABS)
11	30186	Washer – Pinion Nut	45	— ⁽³⁾	Hub Assembly
12	30185	Pinion Nut	46	— ⁽²⁾	Spacer – Flat
	707192X	KIT – Carrier Cover (inc 13, 14, 15)	47	— ⁽²⁾	Washer – Flat
13	— ⁽⁴⁾	Carrier Cover	48	46085	Slotted Nut
14	36472	Plug – Carrier Cover	49	500025-10	Cotter Pin
15	34279	Bolt – Carrier Cover (qty 10)	50	50429 ⁽⁶⁾	Bushing – Synthetic
16	38615	RTV Silicone Sealant	51	45770	Output Shaft
17	— ⁽³⁾	Differential Bearing Cap		75265X	KIT – Front Axle Shaft (inc 51, 68)
18	48632-1	Bolt – Differential Bearing Cap	52	500396-10	Bolt – Disconnect Assembly
19	706032X	KIT – Differential Bearing	53	500357-9	Lockwasher
20	706086X	PKG – Differential Bearing Shim	54	— ⁽³⁾	Brake Line Clip
21	— ⁽¹⁾	Case – Differential	55	43424	Protection Shield
22	41221	Bolt – Drive Gear (qty 10)		— ⁽³⁾	Cover & Motor Assembly
23	— ⁽²⁾	Pinion – Differential			(inc 56, 57, 58, 59, 60, 61, 62, 63, 64)
24	— ⁽²⁾	Gear – Differential	56	— ⁽⁴⁾	Motor Assembly
25	13338-3	Thrustwasher – Differential Pinion	57	— ⁽⁴⁾	O-Ring
26	— ⁽²⁾	Thrustwasher – Differential Gear	58	— ⁽⁴⁾	Cover – Housing
27	39194	Shaft – Differential	59	— ⁽⁴⁾	O-Ring
28	13449	Lock – Differential Shaft	60	— ⁽⁴⁾	Switch Assembly
29	620216	Seal – Tube (left side)	61	— ⁽⁴⁾	Snap Ring
	707315X	KIT – Socket Assembly	62	— ⁽⁴⁾	Snap Ring
		(inc items 30, 31, 32, 33, 34)	63	— ⁽⁴⁾	Shift Fork
30	500024-6	Cotter Pin	64	— ⁽⁴⁾	Clip
31	40584	Nut – Slotted	65	46401	Clutch Collar
32	40916	Upper Socket	66	41494	Gasket
33	35566	Lock Nut	67	43154	Seal – Tube (right side)
34	40113	Socket Assembly – Lower	68	43337	Bushing
35	— ⁽²⁾	Stop Screw	69	— ⁽²⁾	Oil Seal
36	— ⁽²⁾	Jam Nut	70	42570	Snap Ring – Output Shaft (if required)

(1) See "Bill of Material Table" on next page

(2) See "Variable Parts Table" within this section

(3) Contact Vehicle Manufacturer

(4) Not Sold Separately

(5) See Spicer Chassis Catalog for part number and additional steering parts

(6) Bearing Assembly 566008 was used in older models and is still available for service

Dodge Model 44 /216 Disconnect Front-Ram

Bill of Material Table

Axle			Axle Kits				Shaft & Joint Assy.	
Bill of Material	Diff. Type	Ratio	Ring Gear & Pinion Kit ⁽⁷⁾	Differential			Right Hand Shaft Assy.	Left Hand Shaft Assy.
				Case Assy. Kit ⁽⁸⁾	Case Kit	Inner Parts Kit		
1994-94 1/2 W1500								
610422-1	Standard	3.54	707338-1X	707021X	706024X	707025X	76812-1X	76813-1X
610422-2	Standard	3.92	707338-2X	707022X	706025X	707025X	76812-1X	76813-1X
610424-1	Standard	3.54	707338-1X	707021X	706024X	707025X	74759-1X	74760-1X
610424-2	Standard	3.92	707338-2X	707022X	706025X	707025X	74759-1X	74760-1X
1994-94 1/2 W2500								
610423-1	Standard	3.92	707338-2X	707022X	706025X	707025X	76812-1X	76813-1X
610423-2	Standard	4.09	707338-3X	707022X	706025X	707025X	76812-1X	76813-1X
610423-4	Standard	3.54	707338-1X	707021X	706024X	707025X	76812-1X	76813-1X
610425-1	Standard	3.92	707338-2X	707022X	706025X	707025X	74759-1X	74760-1X
610425-2	Standard	4.09	707338-3X	707022X	706025X	707025X	74759-1X	74760-1X
610425-4	Standard	3.54	707338-1X	707021X	706024X	707025X	74759-1X	74760-1X
1995 W1500								
610514-1	Standard	3.54	707338-1X	707021-1X	706024X	707025-1X	74759-1X	74760-1X
610514-2	Standard	3.92	707338-2X	707022-1X	706025X	707025-1X	74759-1X	74760-1X
1995 W2500								
610515-1	Standard	3.54	707338-1X	707021-1X	706024X	707025-1X	74759-1X	74760-1X
610515-2	Standard	3.92	707338-2X	707022-1X	706025X	707025-1X	74759-1X	74760-1X
610515-3	Standard	4.09	707338-3X	707022-1X	706025X	707025-1X	74759-1X	74760-1X
1995-95 1/2 W1500								
610537-1	Standard	3.54	707338-1X	707021-1X	706024X	707025-1X	74759-1X	74760-1X
610537-2	Standard	3.92	707338-2X	707022-1X	706025X	707025-1X	74759-1X	74760-1X
1995-95 1/2 W2500								
610538-1	Standard	3.54	707338-1X	707021-1X	706024X	707025-1X	74759-1X	74760-1X
610538-2	Standard	3.92	707338-2X	707022-1X	706025X	707025-1X	74759-1X	74760-1X
610538-3	Standard	4.09	707338-3X	707022-1X	706025X	707025-1X	74759-1X	74760-1X
1995-96 1/2 W1500								
610512-1	Standard	3.54	707338-1X	707021-1X	706024X	707025-1X	76812-1X	76813-1X
610512-2	Standard	3.92	707338-2X	707022-1X	706025X	707025-1X	76812-1X	76813-1X
1995-96 1/2 W2500								
610513-1	Standard	3.54	707338-1X	707021-1X	706024X	707025-1X	76812-1X	76813-1X
610513-2	Standard	3.92	707338-2X	707022-1X	706025X	707025-1X	76812-1X	76813-1X
610513-3	Standard	4.09	707338-3X	707022-1X	706025X	707025-1X	76812-1X	76813-1X
1996 W1500								
610602-1	Standard	3.54	707338-1X	707021-1X	706024X	707025-1X	74759-1X	74760-1X
610602-2	Standard	3.92	707338-2X	707022-1X	706025X	707025-1X	74759-1X	74760-1X
610612-1	Standard	3.54	707338-1X	707021-1X	706024X	707025-1X	76812-1X	76813-1X
610612-2	Standard	3.92	707338-2X	707022-1X	706025X	707025-1X	76812-1X	76813-1X
1996 W2500								
610603-1	Standard	3.54	707338-1X	707021-1X	706024X	707025-1X	74759-1X	74760-1X
610603-2	Standard	3.92	707338-2X	707022-1X	706025X	707025-1X	74759-1X	74760-1X
610603-3	Standard	4.09	707338-3X	707022-1X	706025X	707025-1X	74759-1X	74760-1X
610613-1	Standard	3.54	707338-1X	707021-1X	706024X	707025-1X	76812-1X	76813-1X
610613-2	Standard	3.92	707338-2X	707022-1X	706025X	707025-1X	76812-1X	76813-1X
610613-3	Standard	4.09	707338-3X	707022-1X	706025X	707025-1X	76812-1X	76813-1X

(7) See Ring Gear & Pinion Kits in XGI Catalog for ratio & tooth combinations.

(8) See Differential Case Assy Kits in XGI Catalog for spline data & ratios.

Dodge Model 44 /216 Disconnect Front-Ram

Bill of Material Table

Axle			Axle Kits				Shaft & Joint Assy.	
Bill of Material	Diff. Type	Ratio	Ring Gear & Pinion Kit ⁽⁷⁾	Differential			Right Hand Shaft Assy.	Left Hand Shaft Assy.
				Case Assy. Kit ⁽⁸⁾	Case Kit	Inner Parts Kit		
1996 1/2 W1500								
610614-1	Standard	3.54	707338-1X	707021-1X	706024X	707025-1X	74759-1X	74760-1X
610614-2	Standard	3.92	707338-2X	707022-1X	706025X	707025-1X	74759-1X	74760-1X
1996 1/2 W2500								
610615-1	Standard	3.54	707338-1X	707021-1X	706024X	707025-1X	74759-1X	74760-1X
610615-2	Standard	3.92	707338-2X	707022-1X	706025X	707025-1X	74759-1X	74760-1X
610615-3	Standard	4.09	707338-3X	707022-1X	706025X	707025-1X	74759-1X	74760-1X
1997-97 1/2 W1500								
610631-1	Standard	3.54	707338-1X	707021-1X	706024X	707025-1X	76812-1X	76813-1X
610631-2	Standard	3.92	707338-2X	707022-1X	706025X	707025-1X	76812-1X	76813-1X
610633-1	Standard	3.54	707338-1X	707021-1X	706024X	707025-1X	74759-1X	74760-1X
610633-2	Standard	3.92	707338-2X	707022-1X	706025X	707025-1X	74759-1X	74760-1X
1997-97 1/2 W2500								
610632-1	Standard	3.54	707338-1X	707021-1X	706024X	707025-1X	76812-1X	76813-1X
610632-2	Standard	3.92	707338-2X	707022-1X	706025X	707025-1X	76812-1X	76813-1X
610632-3	Standard	4.09	707338-3X	707022-1X	706025X	707025-1X	76812-1X	76813-1X
610634-1	Standard	3.54	707338-1X	707021-1X	706024X	707025-1X	74759-1X	74760-1X
610634-2	Standard	3.92	707338-2X	707022-1X	706025X	707025-1X	74759-1X	74760-1X
610634-3	Standard	4.09	707338-3X	707022-1X	706025X	707025-1X	74759-1X	74760-1X
1998 W1500								
610814-1	Standard	3.54	707338-1X	707021-1X	706024X	707025-1X	76812-1X	76813-1X
610814-2	Standard	3.92	707338-2X	707022-1X	706025X	707025-1X	76812-1X	76813-1X
610815-1	Standard	3.54	707338-1X	707021-1X	706024X	707025-1X	76812-1X	76813-1X
610815-2	Standard	3.92	707338-2X	707022-1X	706025X	707025-1X	76812-1X	76813-1X
1998-98 1/2 W1500								
610715-1	Standard	3.54	707338-1X	707021-1X	706024X	707025-1X	76812-1X	76813-1X
610715-2	Standard	3.92	707338-2X	707022-1X	706025X	707025-1X	76812-1X	76813-1X
610717-1	Standard	3.54	707338-1X	707021-1X	706024X	707025-1X	76812-1X	76813-1X
610717-2	Standard	3.92	707338-2X	707022-1X	706025X	707025-1X	76812-1X	76813-1X
1998 1/2 W1500								
610792-1	Standard	3.54	707338-1X	707021-1X	706024X	707025-1X	76812-1X	76813-1X
610792-2	Standard	3.92	707338-2X	707022-1X	706025X	707025-1X	76812-1X	76813-1X
610793-1	Standard	3.54	707338-1X	707021-1X	706024X	707025-1X	76812-1X	76813-1X
610793-2	Standard	3.92	707338-2X	707022-1X	706025X	707025-1X	76812-1X	76813-1X

(7) See Ring Gear & Pinion Kits in XGI Catalog for ratio & tooth combinations.

(8) See Differential Case Assy Kits in XGI Catalog for spline data & ratios.

Dodge Model 44 /216 Disconnect Front-Ram Variable Parts Listing

Kits & Parts - Use With All Applications							
Description & Item Number (Refer to "Exploded View" at the front of this section)			Bills of Material				
			610422 610423	610424 610425	610512 610513	610514 610515	610537 610538
4	Pinion – Differential	23	17717	17717	45872	45872	45872
5	Gear – Differential	24	40194	40194	45870	45870	45870
6	Thrustwasher – Differential Gear	26	40196	40196	32121	32121	32121
11	Stop Screw	35	31026-2	31026-2	31026-2	31026-2	31026-2
12	Jam Nut	36	500381-3	500381-3	500381-3	500381-3	500381-3
13	Slinger	43	45942	—	45942	—	—
14	Shaft & Slinger Assembly	-	74916X	—	74916X	—	—
15	Shaft & Tone Ring Assembly (ABS)	44	—	74917X	—	74917X	74917X
16	Spacer – Flat	46	44997	44997	44997	44997	44997
17	Washer – Flat	47	45523-1	45523-1	45523	45523-1	45523
19	Oil Seal	69	49254	—	49254	—	—
			610602 610603	610612 610613	610614 610615	610631	610632
4	Pinion – Differential	23	45872	45872	45872	45872	45872
5	Gear – Differential	24	45870	45870	45870	45870	45870
6	Thrustwasher – Differential Gear	26	32121	32121	32121	32121	32121
11	Stop Screw	35	31026-2	31026-2	31026-2	31026-2	31026-2
12	Jam Nut	36	500381-3	500381-3	500381-3	500381-3	500381-3
13	Slinger	43	—	45942	—	45942	45942
14	Shaft & Slinger Assembly	-	—	74916X	—	74916X	74916X
15	Shaft & Tone Ring Assembly (ABS)	44	74917X	—	74917X	—	—
16	Spacer – Flat	46	44997	44997	44997	44997	44997
17	Washer – Flat	47	45523	45523	45523	45523	45523
19	Oil Seal	69	—	49254	—	49254	—
			610633 610634	610715	610717	610792	610793
4	Pinion – Differential	23	45872	45872	45872	45872	45872
5	Gear – Differential	24	45870	45870	45870	45870	45870
6	Thrustwasher – Differential Gear	26	32121	32121	32121	32121	32121
11	Stop Screw	35	31026-2	31026-2	31026-2	31026-3	31026-3
12	Jam Nut	36	500381-3	500381-3	500381-3	49270	49270
13	Slinger	43	—	45942	45942	45942	45942
14	Shaft & Slinger Assembly	-	—	74916X	—	74916X	—
15	Shaft & Tone Ring Assembly (ABS)	44	74917X	—	74917X	—	74917X
16	Spacer – Flat	46	44997	44997	48352	44997	48352
17	Washer – Flat	47	45523	45523	45523	45523	45523
19	Oil Seal	69	—	49254	49254	49254	49254
			610814	610815			
4	Pinion – Differential	23	45872	45872			
5	Gear – Differential	24	45870	45870			
6	Thrustwasher – Differential Gear	26	32121	32121			
11	Stop Screw	35	31026-3	31026-3			
12	Jam Nut	36	49270	49270			
13	Slinger	43	45942	45942			
14	Shaft & Slinger Assembly	-	74916X	—			
15	Shaft & Tone Ring Assembly (ABS)	44	—	74917X			
16	Spacer – Flat	46	44997	48352			
17	Washer – Flat	47	45523	45523			
19	Oil Seal	69	49254	49254			

Dodge / Chrysler 1979-1993

Model 60 /248 Front Axles for

D-600 and D-700

Dodge Model 60 /248 Front Axles Exploded View

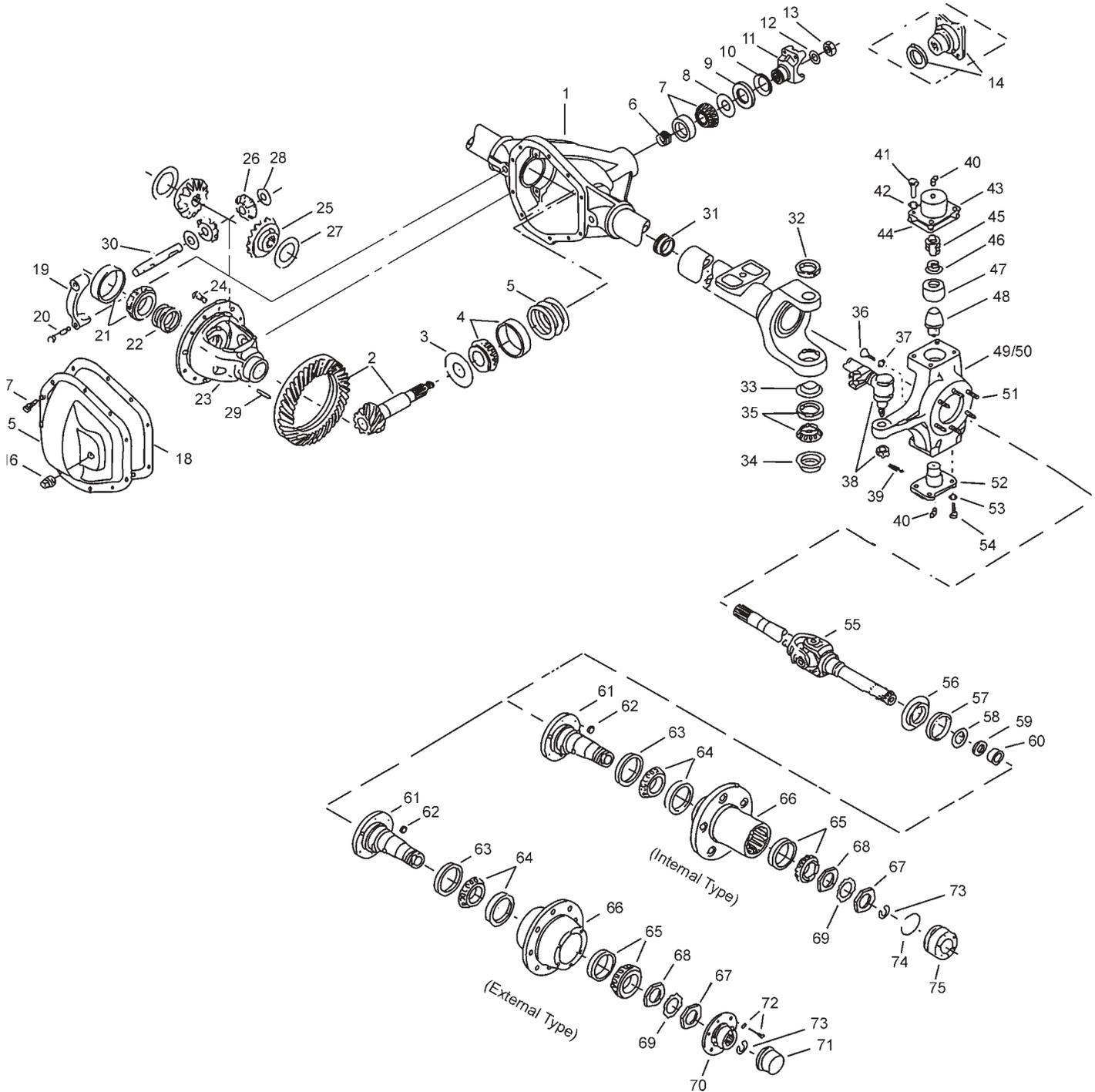

Dodge Model 60 /248 Front Axles

Parts Listing

ITEM NO.	PART NUMBER	DESCRIPTION	ITEM NO.	PART NUMBER	DESCRIPTION
1	— ⁽³⁾	Housing – Axle Service	37	500381-5	Jam Nut
2	— ⁽¹⁾	Drive Pinion & Gear Assembly	38	— ⁽⁵⁾	Tie Rod Assembly
3	34643	Slinger – Inner Pinion Bearing	39	— ⁽⁵⁾	Cotter Pin
4	706046X	KIT – Inner Pinion Bearing	40	500175-4	Lube Fitting
5	— ⁽⁴⁾	Inner Pinion Shims (see shim packages)	41	30875	Nut – Hex Tapered
6	— ⁽⁴⁾	Outer Pinion Shims (see shim packages)	42	—	Lockwasher – King Pin Cap (upper) (not required on this model)
	708020	PKG – Diff & Pinion Bearing Shim (inc items 5,6,13,18,22)	43	38520	Arm – Steering (LH only)
	706359X	PKG – Pinion Bearing Shim (inc items 5,6,12,13,18)	44	37307	Gasket – King Pin Cap
7	706045X	KIT – Outer Pinion Bearing	45	620132	Cap – King Pin (Upper – RH only)
8	42737	Thrustwasher – Bearing	46	37300	Spring – Pressure
9	42449	Seal – Pinion Oil	47	620180	Spring Retainer
10	34592	Slinger – End Yoke	48	41886	King Pin Bushing
11	— ⁽²⁾	End Yoke Assembly (inc 10)	49	37302	King Pin
12	30275	Washer – Pinion Nut	50	— ⁽³⁾	Right Knuckle
13	30271	Pinion Nut	51	— ⁽³⁾	Left Knuckle
14	—	Companion Flange Assembly	52	37879	Bolt – Hex
	— ⁽²⁾	KIT – Carrier Cover (inc items 15, 16, 17)	53	37299	King Pin Bearing Cap – Lower
15	— ⁽²⁾	Carrier Cover	54	500357-13	Lockwasher (King Pin Cap – lower)
16	43180	Plug – Carrier Cover	55	500412-13	Bolt – Hex (King Pin Cap – lower)
17	34822	Bolt – Carrier Cover (qty 10)	56	907967-1	Shaft & Joint Assembly – RH
18	34687	Gasket – Carrier Cover		907967-2	Shaft & Joint Assembly – LH
19	— ⁽³⁾	Differential Bearing Cap	57	37308	Slinger – Spindle Yoke
20	48632-1	Bolt – Differential Bearing Cap		700014	KIT – Spindle Seal & Bearing (inc items 57, 58, 59, 60)
21	706047X	KIT – Differential Bearing	58	700013	KIT – Spindle (inc items 57, 58, 59, 60, 61)
22	708012	PKG – Differential Brg Shim (inc 18)	59	620062	Oil Seal
23	— ⁽¹⁾	Case – Differential	60	37312	Spacer – Wheel Bearing Spindle
24	30266	Bolt – Drive Gear (qty 12)	61	37311	Oil Seal (block-vee)
25	35625	Gear – Differential	62	620063	Needle Bearing Assembly
26	34367	Pinion – Differential	63	620061	Spindle – Wheel Bearing
27	34729	Thrustwasher – Differential Gear	64	36880	Nut – Brake Mounting
28	34730	Thrustwasher – Differential Pinion	65	48816	Oil Seal
29	44810	Lock – Differential Shaft	66	706411X	KIT – Inner Wheel Bearing
30	30263	Shaft – Differential	67	706074X	KIT – Outer Wheel Bearing
31	36487	Seal & Guide Tube	68	— ⁽³⁾	Wheel Hub
	706395X	KIT – King Pin Parts (Lower) (inc items 32, 33, 34, 35)	69	— ⁽²⁾	Spindle Nut
32	620058	King Pin Seal (Upper)	70	— ⁽²⁾	Spindle Nut or Nut/Pin Assembly
33	37305	Grease Retainer	71	— ⁽²⁾	Wheel Bearing Lockwasher
34	41777	Oil Seal	72	— ⁽²⁾	Axle Drive Flange
35	706150X	KIT – King Pin Bearing (Lower)	73	— ⁽²⁾	Hub Cap
36	620143-3	Stop Screw	74	37730	Screw or Screw/Lockwasher Assy
			75	— ⁽³⁾	Snap Ring (small)
					Snap Ring (large)
					Hub Lock Assembly

(1) See "Bill of Material Table" on next page

(2) See "Variable Parts Table" within this section

(3) Contact Vehicle Manufacturer

(4) Not Sold Separately

(5) See Spicer Chassis Catalog for part number and additional steering parts

Dodge Model 60 /248 Front Axles

Bill of Material Table

Axle			Axle Kits				Shaft & Joint Assy.	
Bill of Material	Diff. Type	Ratio	Ring Gear & Pinion Kit ⁽⁷⁾	Differential			Right Hand Shaft Assy.	Left Hand Shaft Assy.
				Case Assy. Kit ⁽⁸⁾	Case Kit	Inner Parts Kit		
1979-80 D-600								
603643-1	Standard	4.10	706033-3X	706180X	706040X	706702X	907967-1	907967-2
603643-2	Standard	4.88	706033-5X	706182X	706041X	706702X	907967-1	907967-2
603643-3	Standard	4.88	706033-5X	706182X	706041X	706702X	907967-1	907967-2
603643-4	Standard	4.10	706033-3X	706180X	706040X	706702X	907967-1	907967-2
603643-5	Standard	4.88	706033-5X	706182X	706041X	706702X	907967-1	907967-2
603643-6	Standard	4.88	706033-5X	706182X	706041X	706702X	907967-1	907967-2
603643-8	Standard	4.10	706033-3X	706180X	706040X	706702X	907967-1	907967-2
603643-9	Standard	5.86	706033-6X	706182X	706041X	706702X	907967-1	907967-2
603643-10	Standard	4.10	706033-3X	706180X	706040X	706702X	907967-1	907967-2
603643-11	Standard	4.56	706033-4X	706182X	706041X	706702X	907967-1	907967-2
603643-12	Standard	4.56	706033-4X	706182X	706041X	706702X	907967-1	907967-2
1981-85 D-600 & D-700								
610135-1	Standard	4.10	706033-3X	706180X	706040X	706702X	907967-1	907967-2
610135-2	Standard	4.56	706033-4X	706182X	706041X	706702X	907967-1	907967-2
610135-3	Standard	4.56	706033-4X	706182X	706041X	706702X	907967-1	907967-2
610135-4	Standard	4.88	706033-5X	706182X	706041X	706702X	907967-1	907967-2
1985-88 D-600 & D-700								
610236-1	Standard	4.10	706033-3X	706180X	706040X	706702X	907967-1	907967-2
610236-2	Standard	4.56	706033-4X	706182X	706041X	706702X	907967-1	907967-2
610236-3	Standard	4.56	706033-4X	706182X	706041X	706702X	907967-1	907967-2
610236-4	Standard	4.88	706033-5X	706182X	706041X	706702X	907967-1	907967-2
1989 D-600 & D-700								
610332-1	Standard	4.10	706033-3X	706180X	706040X	706702X	907967-1	907967-2
610332-2	Standard	4.56	706033-4X	706182X	706041X	706702X	907967-1	907967-2
610332-3	Standard	4.88	706033-5X	706182X	706041X	706702X	907967-1	907967-2
610332-4	Standard	4.10	706033-3X	706180X	706040X	706702X	907967-1	907967-2
1989-90 D-600								
610341-1	Standard	4.10	706033-3X	706180X	706040X	706702X	907967-1	907967-2
610341-2	Standard	4.56	706033-4X	706182X	706041X	706702X	907967-1	907967-2
610341-3	Standard	4.88	706033-5X	706182X	706041X	706702X	907967-1	907967-2
610341-4	Standard	4.10	706033-3X	706180X	706040X	706702X	907967-1	907967-2
1991-91 1/2 D-600								
610357-1	Standard	4.10	706033-3X	706180X	706040X	706702X	907967-1	907967-2
610357-2	Standard	4.56	706033-4X	706182X	706041X	706702X	907967-1	907967-2
610357-3	Standard	4.88	706033-5X	706182X	706041X	706702X	907967-1	907967-2
610357-4	Standard	4.10	706033-3X	706180X	706040X	706702X	907967-1	907967-2
610357-5	Standard	3.54	706033-1X	706180X	706040X	706702X	907967-1	907967-2
610357-6	Standard	3.54	706033-1X	706180X	706040X	706702X	907967-1	907967-2
610357-7	Standard	4.56	706033-4X	706182X	706041X	706702X	907967-1	907967-2
1992 D-600 (Dead Front)								
610398-2	Standard	4.56	-	-	-	-	-	-
610398-4	Standard	4.10	-	-	-	-	-	-
610398-5	Standard	4.56	-	-	-	-	-	-
610398-6	Standard	3.54	-	-	-	-	-	-
610398-7	Standard	4.56	-	-	-	-	-	-

(7) See Ring Gear & Pinion Kits in XGI Catalog for ratio & tooth combinations.

(8) See Differential Case Assy Kits in XGI Catalog for spline data & ratios.

Dodge Model 60 /248 Front Axles Bill of Material Table

Axle			Axle Kits				Shaft & Joint Assy.	
Bill of Material	Diff. Type	Ratio	Ring Gear & Pinion Kit ⁽⁷⁾	Differential			Right Hand Shaft Assy.	Left Hand Shaft Assy.
				Case Assy. Kit ⁽⁸⁾	Case Kit	Inner Parts Kit		
1992-92 1/2 D-600 & D-700								
610430-1	Standard	4.56	706033-4X	706182X	706041X	706702X	907967-1	907967-2
610430-2	Standard	4.10	706033-3X	706180X	706040X	706702X	907967-1	907967-2
610430-3	Standard	3.54	706033-1X	706180X	706040X	706702X	907967-1	907967-2
610430-4	Standard	4.10	706033-3X	706180X	706040X	706702X	907967-1	907967-2
1993 D-600 & D-700								
610405-1	Standard	4.10	706033-3X	706180X	706040X	706702X	907967-1	907967-2
610405-2	Standard	4.56	706033-4X	706182X	706041X	706702X	907967-1	907967-2
610405-4	Standard	4.10	706033-3X	706180X	706040X	706702X	907967-1	907967-2
610405-5	Standard	3.54	706033-1X	706180X	706040X	706702X	907967-1	907967-2
610405-6	Standard	3.54	706033-1X	706180X	706040X	706702X	907967-1	907967-2
610405-7	Standard	4.56	706033-4X	706182X	706041X	706702X	907967-1	907967-2
610405-8	Standard	3.54	706033-1X	706180X	706040X	706702X	907967-1	907967-2
610405-9	Standard	4.10	706033-3X	706180X	706040X	706702X	907967-1	907967-2
610405-10	Standard	4.56	706033-4X	706182X	706041X	706702X	907967-1	907967-2
610405-11	Standard	3.54	706033-1X	706180X	706040X	706702X	907967-1	907967-2
610405-12	Standard	4.10	706033-3X	706180X	706040X	706702X	907967-1	907967-2
610405-13	Standard	4.56	706033-4X	706182X	706041X	706702X	907967-1	907967-2

(7) See Ring Gear & Pinion Kits in XGI Catalog for ratio & tooth combinations.

(8) See Differential Case Assy Kits in XGI Catalog for spline data & ratios.

Dodge Model 60 /248 Front Axles Variable Parts Listing

Kits & Parts - Use With All Applications							
Description & Item Number (Refer to "Exploded View" at the front of this section)			Bills of Material				
			603643	610135 610136	610332	610341 610357	610398
1	End Yoke Assembly (inc 10)	11	2-4-3801X	2-4-8391-1X	2-4-8391-1X	2-4-8391-1X	—
2	KIT – Carrier Cover	-	707182X	707182X	707229X	707229X	—
3	Carrier Cover	15	42799-2	42799-2	43600-1	43600-1	—
4	Spindle Nut	67	35270	35270	35270	621027	—
5	Spindle Nut or Nut/Pin Assembly	68	35270	35270	35270	660568	—
6	Wheel Bearing Lockwasher	69	35269	35269	35269	621028	—
7	Axle Drive Flange	70	37313	—	—	—	—
8	Hub Cap	71	32001	—	—	—	—
9	Screw or Screw/Lockwasher Assy	72	37734	37734	37734	45886	—
10	Snap Ring (large)	74	—	—	—	620097	—
			610405				
			610430				
1	End Yoke Assembly (inc 10)	11	2-4-8391-1X				
2	KIT – Carrier Cover	-	707229X				
3	Carrier Cover	15	43600-1				
4	Spindle Nut	67	621027				
5	Spindle Nut or Nut/Pin Assembly	68	660568				
6	Wheel Bearing Lockwasher	69	621028				
7	Axle Drive Flange	70	—				
8	Hub Cap	71	—				
9	Screw or Screw/Lockwasher Assy	72	45886				
10	Snap Ring (large)	74	620097				

Dodge / Chrysler 1994-1998 1/2

**Model 60 /248 Front
Disconnect Axles for**

**D3500, W2500, W3500
Air Force Tow Vehicle**

Dodge Model 60 /248 Disconnect Front Axles Exploded View

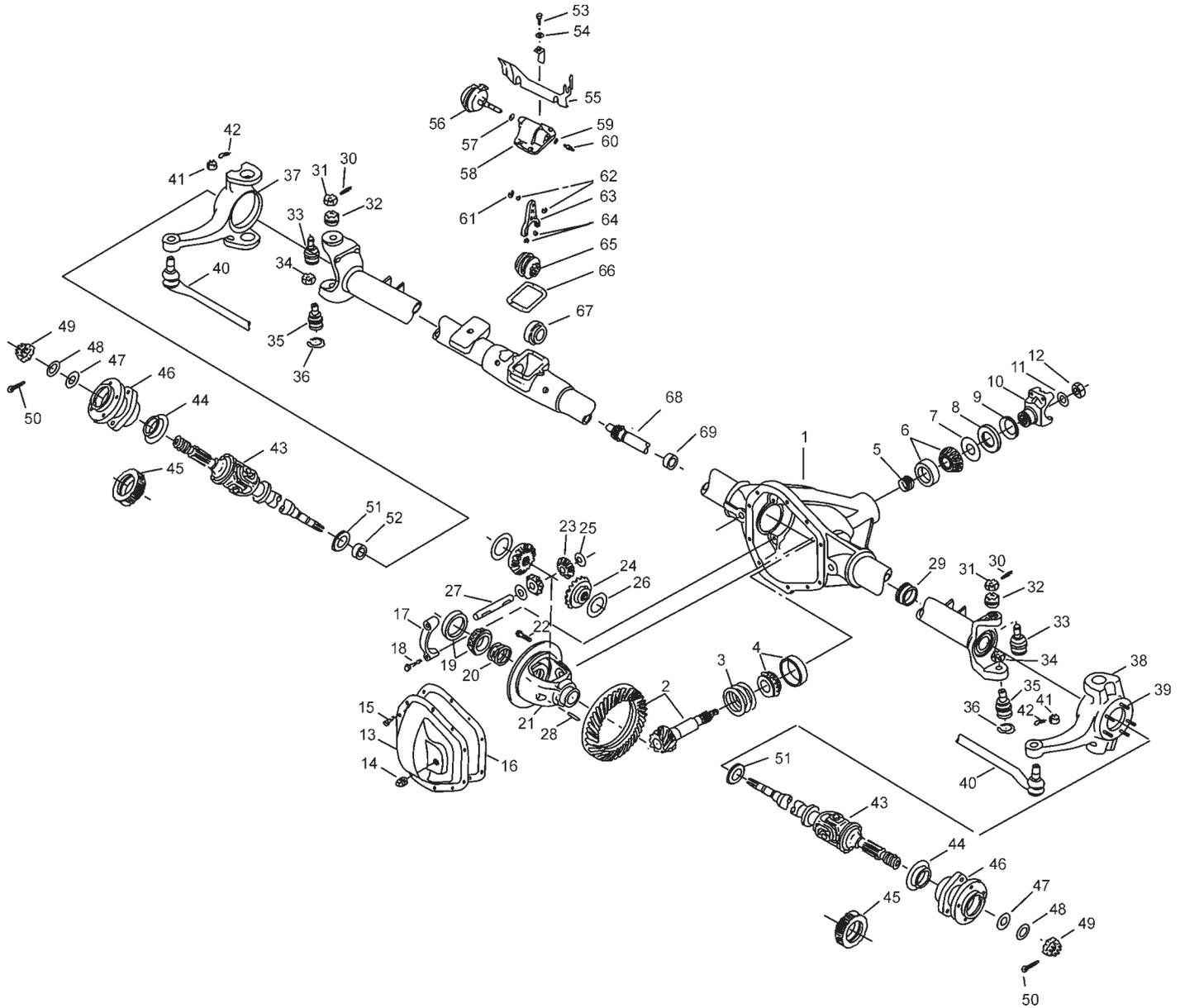

Dodge Model 60 /248 Disconnect Front Axles Parts Listing

ITEM NO.	PART NUMBER	DESCRIPTION	ITEM NO.	PART NUMBER	DESCRIPTION
1	— ⁽³⁾	Housing – Axle Service	36	620343	Snap Ring
2	— ⁽¹⁾	Drive Pinion & Gear Assembly	37	— ⁽³⁾	Knuckle (RH)
3	701126X	PKG – Inner Pinion Shim	38	— ⁽³⁾	Knuckle (LH)
4	706046X	KIT – Inner Pinion Bearing	39	45524	Bolt – Knuckle
5	45658	Collapsible Spacer	40	— ⁽⁵⁾	Tie Rod Assembly
6	706045X	KIT – Outer Pinion Bearing	41	— ⁽⁵⁾	Nut – Slotted
7	42737	Thrustwasher – Bearing	42	— ⁽⁵⁾	Cotter Pin
8	— ⁽²⁾	Seal – Pinion Oil	43	— ⁽¹⁾	Shaft & Joint Assembly
9	— ⁽²⁾	Slinger – End Yoke	44	45520	Slinger
10	— ⁽²⁾	End Yoke Assembly (inc 9)		— ⁽²⁾	Shaft & Slinger Assembly
11	30275	Washer – Pinion Nut	45	— ⁽²⁾	Shaft/Slinger/Tone Ring Assy (ABS)
12	30271	Pinion Nut	46	— ⁽³⁾	Hub Assembly
	— ⁽²⁾	KIT – Carrier Cover	47	— ⁽²⁾	Spacer – Flat
13	— ⁽⁴⁾	Carrier Cover	48	45523	Washer – Flat
14	43180	Plug – Carrier Cover	49	46085	Slotted Nut
15	34822	Bolt – Carrier Cover (qty 10)	50	500025-10	Cotter Pin
16	38615	RTV Silicone Sealant	51	—	Oil Seal
17	— ⁽³⁾	Differential Bearing Cap	52	43337	Bushing
18	48632-1	Bolt – Differential Bearing Cap	53	500396-10	Bolt – Disconnect Assembly
19	706047X	KIT – Differential Bearing	54	500357-9	Lockwasher – Disconnect Assembly
20	708012	PKG – Differential Bearing Shims	55	43424	Protection Shield
21	— ⁽¹⁾	Case – Differential		— ⁽³⁾	Disconnect Cover & Motor Assembly
22	40638	Bolt – Drive Gear (qty 12)	56	— ⁽⁴⁾	Motor Assembly
23	— ⁽²⁾	Pinion – Differential	57	— ⁽⁴⁾	O-Ring
24	— ⁽²⁾	Gear – Differential	58	— ⁽⁴⁾	Cover – Housing
25	34730	Thrustwasher – Differential Pinion	59	— ⁽⁴⁾	O-Ring
26	— ⁽²⁾	Thrustwasher – Differential Gear	60	— ⁽⁴⁾	Switch Assembly
27	30263	Shaft – Differential	61	— ⁽⁴⁾	Snap Ring
28	44810	Lock – Differential Shaft	62	— ⁽⁴⁾	Snap Ring
29	— ⁽²⁾	Seal – Tube (left side)	63	— ⁽⁴⁾	Shift Fork
	707469X	KIT – Socket Assembly	64	— ⁽⁴⁾	Clip
30	— ⁽²⁾	Cotter Pin	65	— ⁽²⁾	Clutch Collar
31	44101	Nut – Hex Slotted	66	41494	Gasket
32	44507	Bushing – 0° Caster	67	— ⁽²⁾	Seal – Tube (right side)
33	40126	Upper Socket	68	— ⁽²⁾	Output Shaft
34	44133	Lock Nut	69	— ⁽²⁾	Bushing / Bearing
35	44627	Lower Socket			

(1) See "Bill of Material Table" on next page

(2) See "Variable Parts Table" within this section

(3) Contact Vehicle Manufacturer

(4) Not Sold Separately

(5) See Spicer Chassis Catalog for part number and additional steering parts

Dodge Model 60 /248 Disconnect Front Axles

Bill of Material Table

Axle			Axle Kits				Shaft & Joint Assy.	
Bill of Material	Diff. Type	Ratio	Ring Gear & Pinion Kit ⁽⁷⁾	Differential			Right Hand Shaft Assy.	Left Hand Shaft Assy.
				Case Assy. Kit ⁽⁸⁾	Case Kit	Inner Parts Kit		
1994 D3500 (Dead Front)								
610427	-	-	-	-	-	-	-	-
1994-94 1/2 W2500 HD								
610426-1	Standard	3.54	708009-1	707339X	706040X	707340X	76627X	76628X
610426-2	Standard	4.10	708009-2	707339X	706040X	707340X	76627X	76628X
610440-1	Standard	3.54	708009-1	707339X	706040X	707340X	76471X	76472X
610440-2	Standard	4.10	708009-2	707339X	706040X	707340X	76471X	76472X
1994-94 1/2 W3500								
610428-4	Standard	3.54	708009-1	707339X	706040X	707340X	76471X	76472X
610428-5	Standard	4.10	708009-2	707339X	706040X	707340X	76471X	76472X
1995 D3500 (Dead Front) ABS								
610541	-	-	-	-	-	-	-	-
1995-95 1/2 W2500 HD								
610539-1	Standard	3.54	708009-1	707339-1X	706040X	707340-1X	76627X	76628X
610539-2	Standard	4.10	708009-2	707339-1X	706040X	707340-1X	76627X	76628X
1995-95 1/2 W3500								
610540-1	Standard	3.54	708009-1	707339X	706040X	707340X	76627X	76628X
610540-2	Standard	4.10	708009-2	707339X	706040X	707340X	76627X	76628X
1995-96 1/2 D3500 (Dead Front)								
610530	-	-	-	-	-	-	-	-
1995-96 Air Force Tow Vehicle Non-ABS								
610532-1	Standard	7.17	707345-3X	706037X	706041X	706043X	76471X	76472X
610532-2	Standard	7.17	707345-3X	707380X	706041X	707340-1X	76471X	76472X
1995-96 W2500 HD								
610518-1	Standard	3.54	708009-1	707339-1X	706040X	707340-1X	76471X	76472X
610518-2	Standard	4.10	708009-2	707339-1X	706040X	707340-1X	76471X	76472X
1995-96 W3500								
610517-1	Standard	3.54	708009-1	707339-1X	706040X	707340-1X	76471X	76472X
610517-2	Standard	4.10	708009-2	707339-1X	706040X	707340-1X	76471X	76472X
1996 D3500 (Dead Front) ABS								
610606	-	-	-	-	-	-	-	-
610621	-	-	-	-	-	-	-	-
1996 W2500 HD								
610604-1	Standard	3.54	708009-1	707339-1X	706040X	707340-1X	76627X	76628X
610604-2	Standard	4.10	708009-2	707339-1X	706040X	707340-1X	76627X	76628X
1996 W3500								
610605-1	Standard	3.54	708009-1	707339-1X	706040X	707340-1X	76627X	76628X
610605-2	Standard	4.10	708009-2	707339-1X	706040X	707340-1X	76627X	76628X
1996 1/2 Air Force Tow Vehicle Non-ABS								
610622-1	Standard	7.17	707345-3X	706037X	706041X	706043X	76471X	76472X
1996 1/2 W2500 HD								
610616-1	Standard	3.54	708009-1	707339-1X	706040X	707340-1X	76471X	76472X
610616-2	Standard	4.10	708009-2	707339-1X	706040X	707340-1X	76471X	76472X
610617-1	Standard	3.54	708009-1	707339-1X	706040X	707340-1X	76627X	76628X
610617-2	Standard	4.10	708009-2	707339-1X	706040X	707340-1X	76627X	76628X

(7) See Ring Gear & Pinion Kits in XGI Catalog for ratio & tooth combinations.

(8) See Differential Case Assy Kits in XGI Catalog for spline data & ratios.

Dodge Model 60 /248 Disconnect Front Axles

Bill of Material Table

Axle			Axle Kits				Shaft & Joint Assy.	
Bill of Material	Diff. Type	Ratio	Ring Gear & Pinion Kit ⁽⁷⁾	Differential			Right Hand Shaft Assy.	Left Hand Shaft Assy.
				Case Assy. Kit ⁽⁸⁾	Case Kit	Inner Parts Kit		
1996 1/2 W3500								
610618-1	Standard	3.54	708009-1	707339-1X	706040X	707340-1X	76471X	76472X
610618-2	Standard	4.10	708009-2	707339-1X	706040X	707340-1X	76471X	76472X
610619-1	Standard	3.54	708009-1	707339-1X	706040X	707340-1X	76627X	76628X
610619-2	Standard	4.10	708009-2	707339-1X	706040X	707340-1X	76627X	76628X
1997 D3500 (Dead Front)								
610639	-	-	-	-	-	-	-	-
610731	-	-	-	-	-	-	-	-
1997 D3500 (Dead Front) ABS								
610640	-	-	-	-	-	-	-	-
610732	-	-	-	-	-	-	-	-
1997 W2500 HD								
610635-1	Standard	3.54	708009-1	707339-1X	706040X	707340-1X	76471X	76472X
610635-2	Standard	4.10	708009-2	707339-1X	706040X	707340-1X	76471X	76472X
610636-1	Standard	3.54	708009-1	707339-1X	706040X	707340-1X	76627X	76628X
610636-2	Standard	4.10	708009-2	707339-1X	706040X	707340-1X	76627X	76628X
610708-1	Standard	3.54	708009-1	707339-1X	706040X	707340-1X	76471X	76472X
610708-2	Standard	4.10	708009-2	707339-1X	706040X	707340-1X	76471X	76472X
610727-1	Standard	3.54	708009-1	707339-1X	706040X	707340-1X	76471X	76472X
610727-2	Standard	4.10	708009-2	707339-1X	706040X	707340-1X	76471X	76472X
610728-1	Standard	3.54	708009-1	707339-1X	706040X	707340-1X	76627X	76628X
610728-2	Standard	4.10	708009-2	707339-1X	706040X	707340-1X	76627X	76628X
610745-1	Standard	3.54	708009-1	707339-1X	706040X	707340-1X	76471X	76472X
610745-2	Standard	4.10	708009-2	707339-1X	706040X	707340-1X	76471X	76472X
610746-1	Standard	3.54	708009-1	707339-1X	706040X	707340-1X	76627X	76628X
610746-2	Standard	4.10	708009-1	707339-1X	706040X	707340-1X	76627X	76628X
1997 W3500								
610637-1	Standard	3.54	708009-1	707339-1X	706040X	707340-1X	76471X	76472X
610637-2	Standard	4.10	708009-2	707339-1X	706040X	707340-1X	76471X	76472X
610638-1	Standard	3.54	708009-1	707339-1X	706040X	707340-1X	76627X	76628X
610638-2	Standard	4.10	708009-2	707339-1X	706040X	707340-1X	76627X	76628X
1997 1/2 Air Force Tow Vehicle Non-ABS								
610714-1	Standard	7.17	707345-3X	706037X	706041X	706043X	76471X	76472X
1997 1/2 W2500 HD								
610738-1	Standard	3.54	708009-1	707339-1X	706040X	707340-1X	76471X	76472X
610738-2	Standard	4.10	708009-2	707339-1X	706040X	707340-1X	76471X	76472X
610739-1	Standard	3.54	708009-1	707339-1X	706040X	707340-1X	76627X	76628X
610739-2	Standard	4.10	708009-2	707339-1X	706040X	707340-1X	76627X	76628X
1997 1/2 W3500								
610729-1	Standard	3.54	708009-1	707339-1X	706040X	707340-1X	76471X	76472X
610729-2	Standard	4.10	708009-2	707339-1X	706040X	707340-1X	76471X	76472X
610730-1	Standard	3.54	708009-1	707339-1X	706040X	707340-1X	76627X	76628X
610730-2	Standard	4.10	708009-2	707339-1X	706040X	707340-1X	76627X	76628X

(7) See Ring Gear & Pinion Kits in XGI Catalog for ratio & tooth combinations.

(8) See Differential Case Assy Kits in XGI Catalog for spline data & ratios.

Dodge Model 60 /248 Disconnect Front Axles

Bill of Material Table

Axle			Axle Kits				Shaft & Joint Assy.	
Bill of Material	Diff. Type	Ratio	Ring Gear & Pinion Kit ⁽⁷⁾	Differential			Right Hand Shaft Assy.	Left Hand Shaft Assy.
				Case Assy. Kit ⁽⁸⁾	Case Kit	Inner Parts Kit		
1998 D3500 (Dead Front)								
610724	-	-	-	-	-	-	-	-
610812	-	-	-	-	-	-	-	-
1998 D3500 (Dead Front) ABS								
610725	-	-	-	-	-	-	-	-
610813	-	-	-	-	-	-	-	-
1998 W2500 HD								
610808-1	Standard	3.54	708009-1	707339-1X	706040X	707340-1X	76471X	76472X
610808-2	Standard	4.10	708009-2	707339-1X	706040X	707340-1X	76471X	76472X
610810-1	Standard	3.54	708009-1	707339-1X	706040X	707340-1X	76471X	76472X
610810-2	Standard	4.10	708009-2	707339-1X	706040X	707340-1X	76471X	76472X
1998-98 1/2 W2500 HD								
610719-1	Standard	3.54	708009-1	707339-1X	706040X	707340-1X	76471X	76472X
610719-2	Standard	4.10	708009-2	707339-1X	706040X	707340-1X	76471X	76472X
1998-98 1/2 W3500								
610720-1	Standard	3.54	708009-1	707339-1X	706040X	707340-1X	76471X	76472X
610720-2	Standard	4.10	708009-2	707339-1X	706040X	707340-1X	76471X	76472X
610722-1	Standard	3.54	708009-1	707339-1X	706040X	707340-1X	76471X	76472X
610722-2	Standard	4.10	708009-2	707339-1X	706040X	707340-1X	76471X	76472X
610723-1	Standard	3.54	708009-1	707339X	706040X	707340X	76471X	76472X
610723-2	Standard	4.10	708009-2	707339X	706040X	707340X	76471X	76472X
1998 1/2 W3500								
610809-1	Standard	3.54	708009-1	707339-1X	706040X	707340-1X	76471X	76472X
610809-2	Standard	4.10	708009-2	707339-1X	706040X	707340-1X	76471X	76472X
610811-1	Standard	3.54	708009-1	707339-1X	706040X	707340-1X	76471X	76472X
610811-2	Standard	4.10	708009-2	707339-1X	706040X	707340-1X	76471X	76472X

(7) See Ring Gear & Pinion Kits in XGI Catalog for ratio & tooth combinations.

(8) See Differential Case Assy Kits in XGI Catalog for spline data & ratios.

Dodge Model 60 /248 Disconnect Front Axles

Variable Parts Listing

Kits & Parts - Use With All Applications							
Description & Item Number (Refer to "Exploded View" at the front of this section)			Bills of Material				
			610426	610427	610428 610440	610517 610518	610530
1	Seal - Pinion Oil	8	42449	—	42449	42449	—
2	Slinger – End Yoke	9	34592	—	34592	34592	—
3	End Yoke Assembly (inc 9)	10	2-4-7681-1X	—	2-4-7681-1X	2-4-7681-1X	—
4	KIT - Carrier Cover	-	707335X	—	707335X	707335X	—
5	Pinion - Differential	23	34367	—	34367	46354	—
6	Gear - Differential	24	34394	—	34394	46355	—
7	Thrustwasher - Differential Gear	26	46146	—	46146	46146	—
8	Seal - Tube (left side)	29	620216	—	620216	620216	—
9	Cotter Pin	30	500024-6	500024-9	500024-6	500024-6	500024-9
10	Shaft & Slinger Assembly	-	—	74777X	75689X	75689X	74777X
11	Shaft/Slinger/Tone Ring Assy (ABS)	45	75690X	—	—	—	—
12	Spacer - Flat	47	45935	45935	45935	45935	45935
13	Clutch Collar	65	46401	—	46401	46401	—
14	Seal - Tube (right side)	67	43154	—	43154	43154	—
15	Output Shaft	68	45531	—	45531	45531	—
16	Bushing / Bearing	69	566008	—	566008	566008	—
			610532	610539	610540	610541	610604 610505
1	Seal - Pinion Oil	8	42449	42449	42449	—	42449
2	Slinger – End Yoke	9	34592	34592	34592	—	34592
3	End Yoke Assembly (inc 9)	10	2-4-7681-1X	2-4-7681-1X	2-4-7681-1X	—	2-4-7681-1X
4	KIT - Carrier Cover	-	707335X	707335X	707335X	—	707335X
5	Pinion - Differential	23	34367	46354	34367	—	46354
6	Gear - Differential	24	34394	46355	34394	—	46355
7	Thrustwasher - Differential Gear	26	34729	46146	46146	—	46146
8	Seal - Tube (left side)	29	620216	620216	620216	—	620216
9	Cotter Pin	30	500024-6	500024-6	500024-6	500024-9	500024-6
10	Shaft & Slinger Assembly	-	75689X	—	—	—	—
11	Shaft/Slinger/Tone Ring Assy (ABS)	45	—	75690X	75690X	75356X	75690X
12	Spacer - Flat	47	45935	45935	45935	45935	45935
13	Clutch Collar	65	46401	46401	46401	—	46401
14	Seal - Tube (right side)	67	43154	43154	43154	—	43154
15	Output Shaft	68	45531	45531	45531	—	45531
16	Bushing / Bearing	69	566008	566008	566008	—	566008
			610606	610616	610617	610618	610619
1	Seal - Pinion Oil	8	—	42449	42449	42449	42449
2	Slinger – End Yoke	9	—	34592	34592	34592	34592
3	End Yoke Assembly (inc 9)	10	—	2-4-7681-1X	2-4-7681-1X	2-4-7681-1X	2-4-7681-1X
4	KIT - Carrier Cover	-	—	707335X	707335X	707335X	707335X
5	Pinion - Differential	23	—	46354	46354	46354	46354
6	Gear - Differential	24	—	46355	46355	46355	46355
7	Thrustwasher - Differential Gear	26	—	46146	46146	46146	46146
8	Seal - Tube (left side)	29	—	620216	620216	620216	620216
9	Cotter Pin	30	500024-9	500024-6	500024-6	500024-6	500024-6
10	Shaft & Slinger Assembly	-	—	75689X	—	75689X	—
11	Shaft/Slinger/Tone Ring Assy (ABS)	45	75356X	—	75690X	—	75690X
12	Spacer - Flat	47	45935	45935	45935	45935	45935
13	Clutch Collar	65	—	46401	46401	46401	46401
14	Seal - Tube (right side)	67	—	43154	43154	43154	43154
15	Output Shaft	68	—	45531	45531	45531	45531
16	Bushing / Bearing	69	—	566008	566008	566008	566008

(See next page for additional bills of material)

Dodge Model 60 /248 Disconnect Front Axles

Variable Parts Listing

Kits & Parts - Use With All Applications							
Description & Item Number (Refer to "Exploded View" at the front of this section)			Bills of Material				
			610621	610622	610635	610636	610637
1	Seal - Pinion Oil	8	—	42449	42449	42449	42449
2	Slinger – End Yoke	9	—	34592	34592	34592	34592
3	End Yoke Assembly (inc 9)	10	—	2-4-7681-1X	2-4-7681-1X	2-4-7681-1X	2-4-7681-1X
4	KIT - Carrier Cover	-	—	707335X	707335X	707335X	707335X
5	Pinion - Differential	23	—	34367	46354	46354	46354
6	Gear - Differential	24	—	34394	46355	46355	46355
7	Thrustwasher - Differential Gear	26	—	34729	46146	46146	46146
8	Seal - Tube (left side)	29	—	620216	620216	620216	620216
9	Cotter Pin	30	500024-9	500024-6	500024-6	500024-6	500024-9
10	Shaft & Slinger Assembly	-	—	75689X	75689X	—	75689X
11	Shaft/Slinger/Tone Ring Assy (ABS)	45	75356X	—	—	75690X	—
12	Spacer - Flat	47	45935	45935	45935	45935	45935
13	Clutch Collar	65	—	46401	46401	46401	46401
14	Seal - Tube (right side)	67	—	43154	43154	43154	43154
15	Output Shaft	68	—	45531	45531	45531	45531
16	Bushing / Bearing	69	—	566008	566008	566008	566008
			610638	610639	610640	610708	610714
1	Seal - Pinion Oil	8	42449	—	—	42449	42449
2	Slinger – End Yoke	9	34592	—	—	34592	34592
3	End Yoke Assembly (inc 9)	10	2-4-7681-1X	—	—	2-4-7681-1X	2-4-7681-1X
4	KIT - Carrier Cover	-	707335X	—	—	707335X	707335X
5	Pinion - Differential	23	46354	—	—	46354	34367
6	Gear - Differential	24	46355	—	—	46355	34394
7	Thrustwasher - Differential Gear	26	46146	—	—	46146	34729
8	Seal - Tube (left side)	29	620216	—	—	620216	620216
9	Cotter Pin	30	500024-9	500024-9	500024-9	500024-9	500024-9
10	Shaft & Slinger Assembly	-	—	74777X	—	75689X	75689X
11	Shaft/Slinger/Tone Ring Assy (ABS)	45	75690X	—	75356X	—	—
12	Spacer - Flat	47	45935	45935	45935	45935	45935
13	Clutch Collar	65	46401	—	—	46401	46401
14	Seal - Tube (right side)	67	43154	—	—	43154	43154
15	Output Shaft	68	45531	—	—	45531	45531
16	Bushing / Bearing	69	566008	—	—	566008	566008
			610719 610720 610722	610723	610724 610725	610727	610728
1	Seal - Pinion Oil	8	42449	42449	—	42449	42449
2	Slinger – End Yoke	9	34592	34592	—	34592	34592
3	End Yoke Assembly (inc 9)	10	2-4-7681-1X	2-4-7681-1X	—	2-4-7681-1X	2-4-7681-1X
4	KIT - Carrier Cover	-	707335X	707335X	—	707335X	707335X
5	Pinion - Differential	23	46354	46354	—	46354	46354
6	Gear - Differential	24	46355	46355	—	46355	46355
7	Thrustwasher - Differential Gear	26	46146	46146	—	46146	46146
8	Seal - Tube (left side)	29	620216	620216	—	620216	620216
9	Cotter Pin	30	500024-9	500024-9	500024-9	500024-9	500024-9
10	Shaft & Slinger Assembly	-	75689X	—	74777X	75689X	—
11	Shaft/Slinger/Tone Ring Assy (ABS)	45	—	75690X	—	—	75690X
12	Spacer - Flat	47	45935	48355	45935	45935	45935
13	Clutch Collar	65	46401	46401	—	46401	46401
14	Seal - Tube (right side)	67	43154	43154	—	43154	43154
15	Output Shaft	68	45531	45531	—	45531	45531
16	Bushing / Bearing	69	566008	566008	—	566008	566008

Dodge Model 60 /248 Disconnect Front Axles

Variable Parts Listing

Kits & Parts - Use With All Applications							
Description & Item Number (Refer to "Exploded View" at the front of this section)			Bills of Material				
			610729	610730	610731	610732	610738
1	Seal - Pinion Oil	8	42449	42449	—	—	42449
2	Slinger – End Yoke	9	34592	34592	—	—	34592
3	End Yoke Assembly (inc 9)	10	2-4-7681-1X	2-4-7681-1X	—	—	2-4-7681-1X
4	KIT - Carrier Cover	-	707335X	707335X	—	—	707335X
5	Pinion - Differential	23	46354	46354	—	—	46354
6	Gear - Differential	24	46355	46355	—	—	46355
7	Thrustwasher - Differential Gear	26	46146	46146	—	—	46146
8	Seal - Tube (left side)	29	620216	620216	—	—	620216
9	Cotter Pin	30	500024-9	500024-9	500024-9	500024-9	500024-9
10	Shaft & Slinger Assembly	-	75689X	—	74777X	—	75689X
11	Shaft/Slinger/Tone Ring Assy (ABS)	45	—	75690X	—	75356X	—
12	Spacer - Flat	47	45935	45935	45935	45935	45935
13	Clutch Collar	65	46401	46401	—	—	46401
14	Seal - Tube (right side)	67	43154	43154	—	—	43154
15	Output Shaft	68	45531	45531	—	—	45531
16	Bushing / Bearing	69	566008	566008	—	—	566008
			610739	610745	610746	610808 610809	610810
1	Seal - Pinion Oil	8	42449	42449	42449	42449	42449
2	Slinger – End Yoke	9	34592	34592	34592	34592	34592
3	End Yoke Assembly (inc 9)	10	2-4-7681-1X	2-4-7681-1X	2-4-7681-1X	2-4-7681-1X	2-4-7681-1X
4	KIT - Carrier Cover	-	707335X	707335X	707335X	707335X	707335X
5	Pinion - Differential	23	46354	46354	46354	46354	46354
6	Gear - Differential	24	46355	46355	46355	46355	46355
7	Thrustwasher - Differential Gear	26	46146	46146	46146	46146	46146
8	Seal - Tube (left side)	29	620216	620216	620216	620216	620216
9	Cotter Pin	30	500024-9	500024-9	500024-9	500024-9	500024-9
10	Shaft & Slinger Assembly	-	—	75689X	—	75689X	75689X
11	Shaft/Slinger/Tone Ring Assy (ABS)	45	75690X	—	75690X	—	— ⁽⁹⁾
12	Spacer - Flat	47	45935	45935	45935	45935	45935
13	Clutch Collar	65	46401	46401	46401	46401	46401
14	Seal - Tube (right side)	67	43154	43154	43154	43154	43154
15	Output Shaft	68	45531	45531	45531	45531	45531
16	Bushing / Bearing	69	566008	566008	566008	566008	566008
			610811	610812	610813		
1	Seal - Pinion Oil	8	42449	—	—		
2	Slinger – End Yoke	9	34592	—	—		
3	End Yoke Assembly (inc 9)	10	2-4-7681-1X	—	—		
4	KIT - Carrier Cover	-	707335X	—	—		
5	Pinion - Differential	23	46354	—	—		
6	Gear - Differential	24	46355	—	—		
7	Thrustwasher - Differential Gear	26	46146	—	—		
8	Seal - Tube (left side)	29	620216	—	—		
9	Cotter Pin	30	500024-9	500024-9	500024-9		
10	Shaft & Slinger Assembly	-	—	74777X	74777X		
11	Shaft/Slinger/Tone Ring Assy (ABS)	45	75690X	—	— ⁽⁹⁾		
12	Spacer - Flat	47	45935	48355	48355		
13	Clutch Collar	65	46401	—	—		
14	Seal - Tube (right side)	67	43154	—	—		
15	Output Shaft	68	45531	—	—		
16	Bushing / Bearing	69	566008	—	—		

(9) Contact vehicle manufacturer - Tone ring is provided with the hub, rotor and bearing assembly.

Dodge / Chrysler 1987-1993 1/2

Model 61 Front Axles for

D-600, D-700

Dodge Model 61 Front Axles Exploded View

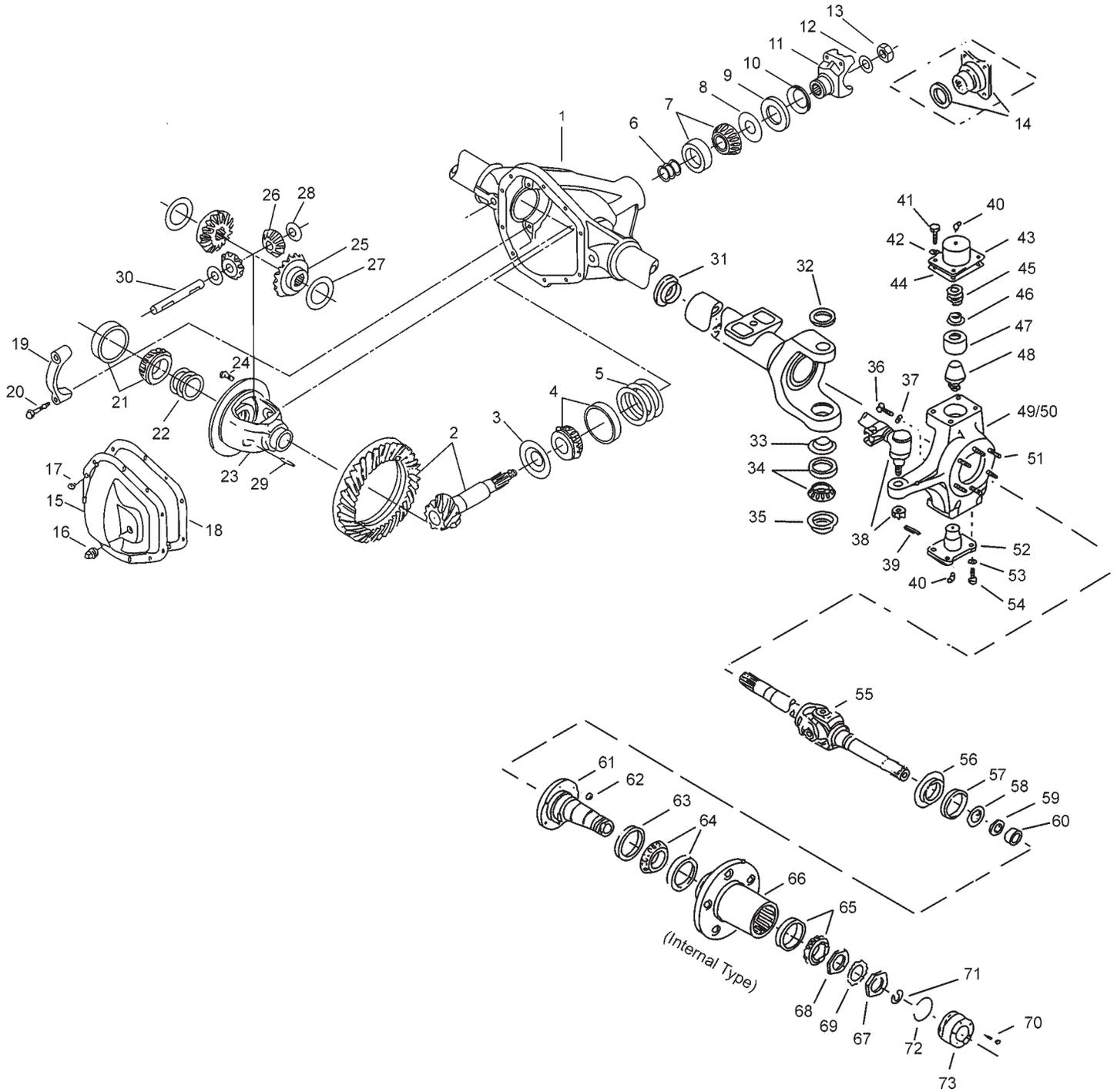

Dodge Model 61 Front Axles Parts Listing

ITEM NO.	PART NUMBER	DESCRIPTION	ITEM NO.	PART NUMBER	DESCRIPTION
1	— ⁽³⁾	Housing – Axle Service	36	620143-3	Stop Screw
2	— ⁽¹⁾	Drive Pinion & Gear Assembly	37	500381-5	Jam Nut
3	34643	Slinger – Inner Pinion Bearing	38	— ⁽⁵⁾	Tie Rod Assembly
4	706046X	KIT – Inner Pinion Bearing	39	— ⁽⁵⁾	Cotter Pin
5	— ⁽⁴⁾	Inner Pinion Bearing Shims (see shim packages)	40	500175-4	Lube Fitting
			41	30875	Nut – Hex Tapered
6	— ⁽⁴⁾	Outer Pinion Bearing Shims (see shim packages)	42	—	Lockwasher – King Pin Cap (upper)
	708020	PKG – Diff & Pinion Bearing Shim (inc items 5, 6, 13, 16, 22)	43	38520	Arm – Steering (LH only)
	706359X	PKG – Pinion Bearing Shim (inc items 5, 7, 12, 13, 16)	44	37307	Gasket – King Pin Cap
				620132	King Pin Cap (upper – RH only)
7	706045X	KIT – Outer Pinion Bearing	45	37300	Spring – Pressure
8	42737	Thrustwasher – Bearing	46	620180	Spring Retainer
9	42449	Seal – Pinion Oil	47	41886	King Pin Bushing
10	232752	Slinger – End Yoke	48	37302	King Pin
11	2-4-8391-1X	End Yoke Assembly (inc 10)	49	— ⁽³⁾	Right Knuckle
12	30275	Washer – Pinion Nut	50	— ⁽³⁾	Left Knuckle
13	30271	Pinion Nut	51	37879	Bolt – Hex
14	—	Companion Flange Assembly	52	37299	King Pin Bearing Cap – Lower
	707229X	KIT – Carrier Cover (inc items 15, 16, 17)	53	500357-13	Lockwasher – King Pin Cap (lower)
15	43600-1	Carrier Cover	54	500412-13	Bolt – Hex (King Pin Cap – lower)
16	43180	Plug – Carrier Cover	55	907967-1	Shaft & Joint Assembly – RH
17	34822	Bolt – Carrier Cover (qty 10)		907967-2	Shaft & Joint Assembly – LH
18	34687	Gasket – Carrier Cover	56	37308	Slinger – Spindle Yoke
19	— ⁽³⁾	Differential Bearing Cap		700014	KIT – Spindle Seal & Bearing (inc items 57, 58, 59, 60)
20	48632-1	Bolt – Differential Bearing Cap		700013	KIT – Spindle (inc items 57, 58, 59, 60, 61)
21	706047X	KIT – Differential Bearing	57	620062	Oil Seal
22	708012	PKG – Diff Bearing Shim (inc 18)	58	37312	Spacer – Wheel Bearing Spindle
23	— ⁽¹⁾	Case – Differential	59	37311	Oil Seal (block-vee)
24	40638	Bolt – Drive Gear (qty 12)	60	620063	Needle Bearing Assembly
25	35625	Gear – Differential	61	620061	Spindle – Wheel Bearing
26	34367	Pinion – Differential	62	36880	Nut – Brake Mounting
27	34729	Thrustwasher – Differential Gear	63	48816	Oil Seal
28	34730	Thrustwasher – Differential Pinion	64	706411X	KIT – Inner Wheel Bearing
29	44810	Lock – Differential Shaft	65	706074X	KIT – Outer Wheel Bearing
30	30263	Shaft – Differential	66	— ⁽³⁾	Wheel Hub
31	36487	Seal & Guide Tube	67	— ⁽²⁾	Spindle Nut
	706395X	KIT – King Pin Parts (inc items 32, 33, 34, 35)	68	— ⁽²⁾	Spindle Nut or Nut/Pin Assembly
			69	— ⁽²⁾	Wheel Bearing Lockwasher
32	620058	King Pin Seal (upper)	70	— ⁽²⁾	Screw or Screw / Lockwasher Assy
33	37305	Grease Retainer	71	37730	Snap Ring (small)
34	41777	Oil Seal	72	— ⁽²⁾	Snap Ring (large)
			73	— ⁽³⁾	Hub Lock Assembly

(1) See "Bill of Material Table" on next page

(2) See "Variable Parts Table" within this section

(3) Contact Vehicle Manufacturer

(4) Not Sold Separately

(5) See Spicer Chassis Catalog for part number and additional steering parts

Dodge Model 61 Front Axles Bill of Material Table

Axle			Axle Kits				Shaft & Joint Assy.	
Bill of Material	Diff. Type	Ratio	Ring Gear & Pinion Kit ⁽⁷⁾	Differential			Right Hand Shaft Assy.	Left Hand Shaft Assy.
				Case Assy. Kit ⁽⁸⁾	Case Kit	Inner Parts Kit		
1987-88 D-600 & D-700								
610265-1	Standard	3.07	706661-11X	706180X	706040X	706702X	907967-1	907967-2
610265-2	Standard	3.54	706033-1X	707072X	706400X	706702X	907967-1	907967-2
610265-3	Standard	3.07	706661-11X	706180X	706040X	706702X	907967-1	907967-2
610265-4	Standard	3.54	706033-1X	706180X	706400X	706702X	907967-1	907967-2
1989 D-600 & D-700								
610333-1	Standard	3.07	706661-11X	706180X	706040X	706702X	907967-1	907967-2
610333-2	Standard	3.54	706033-1X	707072X	706400X	706702X	907967-1	907967-2
610333-3	Standard	3.07	706661-11X	706180X	706040X	706702X	907967-1	907967-2
610342-1	Standard	3.07	706661-11X	706180X	706040X	706702X	907967-1	907967-2
610342-2	Standard	3.54	706033-1X	707072X	706400X	706702X	907967-1	907967-2
610342-3	Standard	3.07	706661-11X	706180X	706040X	706702X	907967-1	907967-2
610342-4	Standard	3.54	706033-1X	707072X	706400X	706702X	907967-1	907967-2
1991-92 D-600 & D-700								
610358-1	Standard	3.07	706661-11X	706180X	706040X	706702X	907967-1	907967-2
610358-2	Standard	3.54	706033-1X	707072X	706400X	706702X	907967-1	907967-2
610358-3	Standard	3.07	706661-11X	706180X	706040X	706702X	907967-1	907967-2
610358-4	Standard	3.54	706033-1X	707072X	706400X	706702X	907967-1	907967-2
1992-92 1/2 D-600 & D-700								
610431-1	Standard	3.07	706661-11X	706180X	706040X	706702X	907967-1	907967-2
1993-93 1/2 D-600 & D-700								
610406-1	Standard	3.07	706661-11X	706180X	706040X	706702X	907967-1	907967-2
610406-2	Standard	3.07	706661-11X	706180X	706040X	706702X	907967-1	907967-2
610406-3	Standard	3.07	706661-11X	706180X	706040X	706702X	907967-1	907967-2
610406-4	Standard	3.07	706661-11X	706180X	706040X	706702X	907967-1	907967-2

(7) See Ring Gear & Pinion Kits in XGI Catalog for ratio & tooth combinations.

(8) See Differential Case Assy Kits in XGI Catalog for spline data & ratios.

Variable Parts Listing

Kits & Parts - Use With All Applications						
Description & Item Number (Refer to "Exploded View" at the front of this section)			Bills of Material			
			610265	610333	610342 610358 610406 610431	
1	Spindle Nut	67	35270	35270	621027	
2	Spindle Nut or Nut/Pin Assembly	68	35270	—	660568	
3	Wheel Bearing Lockwasher	69	35269	35269	621028	
4	Screw or Screw/Lockwasher Assy	70	37734	37734	45886	
5	Snap Ring (large)	72	—	—	620097	

Dodge / Chrysler 1993 1/2-1998

Model 44 /216 ICA Rear Axles for

Viper

Dodge Model 44 /216 ICA Rear Axles Exploded View

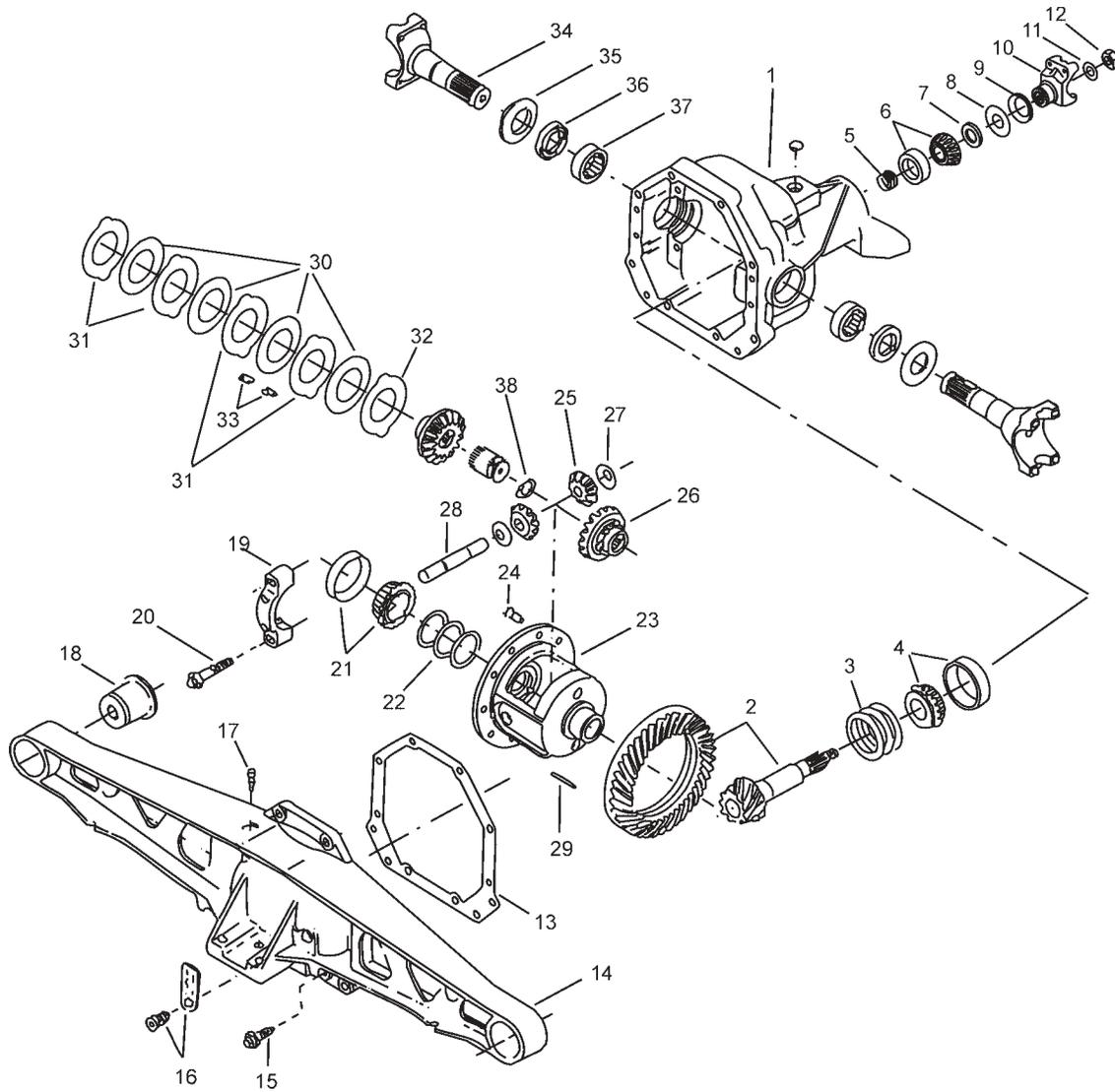

Dodge Model 44 /216 ICA Rear Axles Parts Listing

ITEM NO.	PART NUMBER	DESCRIPTION	ITEM NO.	PART NUMBER	DESCRIPTION
1	— ⁽³⁾	Housing – Axle Service	18	44467-2	Bushing – Carrier Cover
2	— ⁽¹⁾	Drive Pinion & Gear Assembly	19	— ⁽³⁾	Differential Bearing Cap
3	— ⁽⁴⁾	PKG – Inner Pinion Shim (select pkg. based on thickness req)	20	41212	Bolt – Differential Bearing Cap
	72922-1X	Inner Pinion Shim (.030 to .034)	21	706988X	KIT – Differential Bearing
	72922-2X	Inner Pinion Shim (.035 to .039)	22	701005X	PKG – Differential Bearing Shim
	72922-3X	Inner Pinion Shim (.040 to .044)	23	— ⁽¹⁾	Case – Differential
	72922-4X	Inner Pinion Shim (.045 to .049)	24	41221	Bolt – Drive Gear (qty 10)
	72922-5X	Inner Pinion Shim (.050 to .054)	25	— ⁽²⁾	Pinion – Differential
4	707064X	KIT – Inner Pinion Bearing	26	— ⁽²⁾	Gear – Differential
5	43916	Collapsible Spacer	27	13338-3	Thrustwasher – Differential Pinion
6	706123X	KIT – Outer Pinion Bearing	28	41219	Shaft – Differential
7	42737	Thrustwasher – Bearing	29	13449	Lock – Differential Shaft
8	42449	Seal – Pinion Oil		707018X	KIT – Differential Plate & Disc (inc items 30, 31, 32, 33)
9	42501	Seal – End Yoke	30	— ⁽⁴⁾	Disc – Differential
10	3-4-12211-1	End Yoke Assembly	31	— ⁽⁴⁾	Plate – Differential Pressure
11	30275	Washer – Pinion Nut	32	— ⁽⁴⁾	Plate – Differential Dished
12	30271	Pinion Nut	33	40835	Clip – Differential Clutch Retainer
13	38615	RTV Silicone Sealant	34	— ⁽¹⁾	Shaft – Inner Yoke (inc item 35)
14	— ⁽³⁾	Arm – Carrier Cover Support	35	41218	Seal – Inner Yoke Shaft
15	44300	Screw – Carrier Cover	36	45670	Oil Seal
16	39527	Fill Plug	37	566002	Bearing – Yoke Shaft
17	— ⁽²⁾	Breather Vent	38	41323-8	Snap Ring

(1) See "Bill of Material Table" on next page

(2) See "Variable Parts Table" within this section

(3) Contact Vehicle Manufacturer

(4) Not Sold Separately

(5) See Spicer Chassis Catalog for part number and additional steering parts

Dodge Model 44 /216 ICA Rear Axles

Bill of Material Table

Axle			Axle Kits				Shaft & Joint Assy.	
Bill of Material	Diff. Type	Ratio	Ring Gear & Pinion Kit ⁽⁷⁾	Differential			Right Hand Shaft Assy.	Left Hand Shaft Assy.
				Case Assy. Kit ⁽⁸⁾	Case Kit	Inner Parts Kit		
1993 1/2 Viper								
605529-1	Trac Lok	3.07	74436-5X	74705X	-	-	74788-1X	74788-2X
1994-95 1/2 Viper								
605648-1	Trac Lok	3.07	74436-5X	74705X	-	-	74788-1X	74788-2X
1996-97 Viper								
605752-1	Trac Lok	3.07	75402-5X	75499X	-	-	74788-1X	74788-2X
1998-2000 Viper								
606014-1	Trac Lok	3.07	75402-5X	75499X	-	-	74788-1X	74788-2X

(7) See Ring Gear & Pinion Kits in XGI Catalog for ratio & tooth combinations.

(8) See Differential Case Assy Kits in XGI Catalog for spline data & ratios.

Variable Parts Listing

Kits & Parts - Use With All Applications						
	Description & Item Number (Refer to "Exploded View" at the front of this section)		Bills of Material			
			605529 605648	605752 606014		
1	Breather Vent	17	40750	44780		
2	Pinion – Differential (t/l)	25	44010	41193		
3	Gear – Differential (t/l)	26	44008	46618		

Dodge / Chrysler 1979-1998 1/2

Model 60 /248 Rear Axles for

B-300 Maxivan HD

B-600

C-300

D-200, D-300, D-600

D-700, D-800

MB-300 Dual Wheel HD

W-200 HD

Rail Maintenance

High Performance Racing

Dodge Model 60 /248 Rear Axles Exploded View

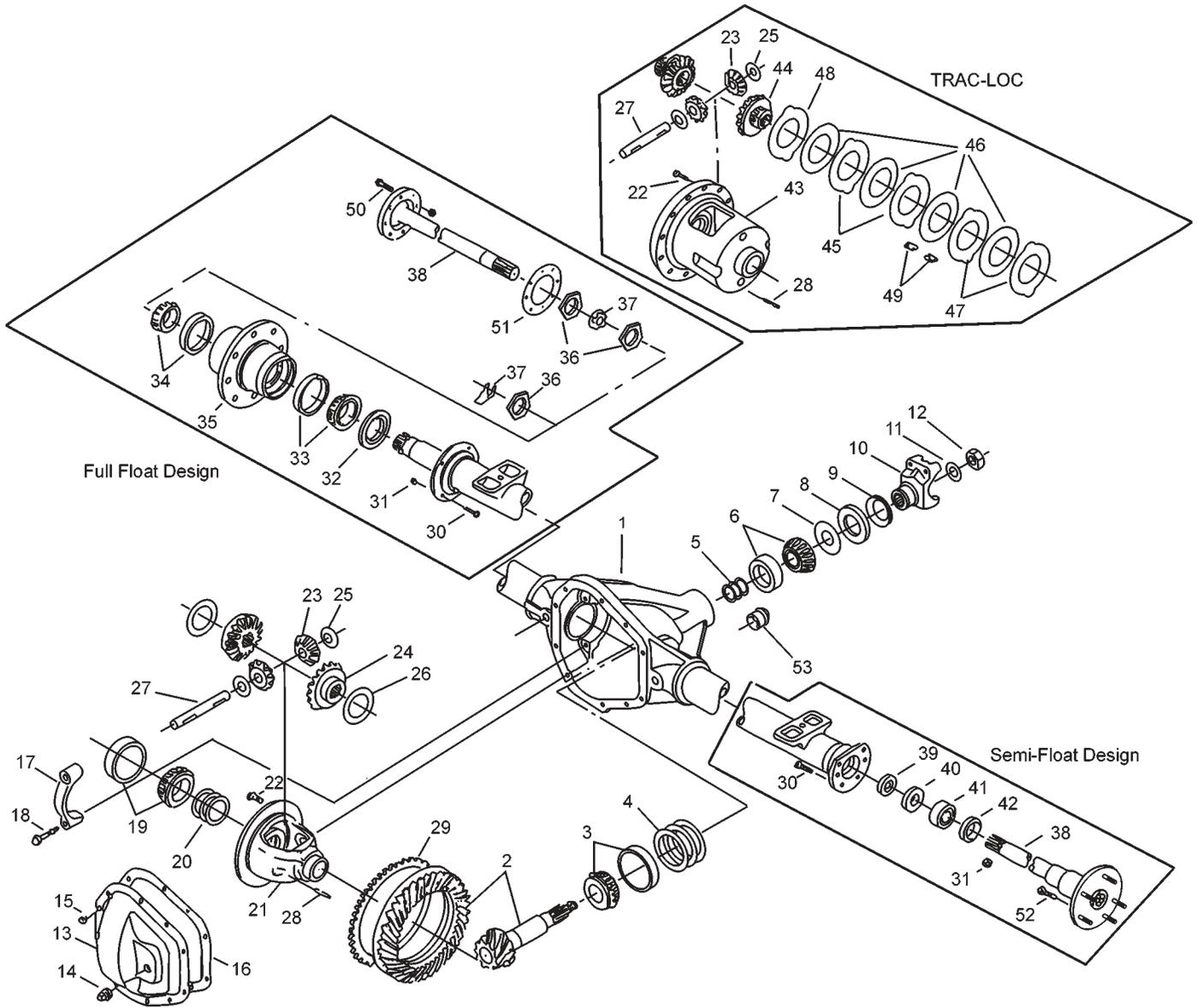

Dodge Model 60 /248 Rear Axles Parts Listing

ITEM NO.	PART NUMBER	DESCRIPTION	ITEM NO.	PART NUMBER	DESCRIPTION
1	— ⁽³⁾	Housing – Axle Service	25	34730	Thrustwasher – Differential Pinion
2	— ⁽¹⁾	Drive Pinion & Gear Assembly	26	34729	Thrustwasher – Differential Gear (std)
3	706046X	KIT – Inner Pinion Bearing	27	30263	Shaft – Differential
	708020	PKG – Diff & Pinion Bearing Shim (inc items 4, 5, 12, 16, 20)	28	44810	Lock – Differential Shaft
	706359X	PKG – Pinion Bearing Shim (inc items 4, 5, 11, 12, 16)	29	42928	Tone Ring (ABS)
4	— ⁽⁴⁾	Inner Pinion Shims (see shim packages)	30	— ⁽³⁾	Bolt – Brake Mounting
5	— ⁽⁴⁾	Outer Pinion Shims (see shim packages)	31	— ⁽³⁾	Nut – Brake Mounting
6	706045X	KIT – Outer Pinion Bearing	32	— ⁽²⁾	Seal – Hub
7	42737	Thrustwasher	33	— ⁽³⁾	KIT – Inner Wheel Bearing
8	42449	Seal – Pinion Oil	34	— ⁽³⁾	KIT – Outer Wheel Bearing
9	34592	Slinger – End Yoke	35	— ⁽³⁾	Wheel Hub
10	— ⁽²⁾	End Yoke Assembly (inc 9)	36	— ⁽²⁾	Spindle Nut
11	30275	Washer – Pinion Nut	37	— ⁽²⁾	Lockwasher / Locking Wedge
12	30271	Pinion Nut	38	— ⁽¹⁾	Shaft – Axle Flanged Drive
	— ⁽²⁾	KIT – Carrier Cover (inc items 13, 14, 15)		706767X	KIT – Unit Brg & Seal (semi-float) (inc items 39, 40, 41, 42)
13	— ⁽²⁾	Carrier Cover	39	35239	Oil Seal
14	43180	Plug – Carrier Cover	40	39378	Oil Seal Retainer
15	34822	Bolt – Carrier Cover (qty 10)	41	565903	Bearing Assembly
16	34687	Gasket – Carrier Cover	42	36797	Bearing Retainer
	38615	RTV Silicone Sealant	43	— ⁽¹⁾	Case – Differential (t/l)
17	— ⁽³⁾	Differential Bearing Cap	44	35803	Gear – Differential (t/l)
18	48632-1	Bolt – Differential Bearing Cap	45	707083X	KIT – Disc & Plate (t/l)
19	706047X	KIT – Differential Bearing	46	— ⁽⁴⁾	Plate – Differential Pressure
20	708012	KIT – Differential Bearing Shim (inc 16)	47	— ⁽⁴⁾	Disc – Differential
21	— ⁽¹⁾	Case – Differential (std)	48	— ⁽⁴⁾	Plate – Diff (selective thickness)
22	— ⁽²⁾	Bolt – Drive Gear (qty 12)	49	40835	Plate – Preload Spacer
23	34367	Pinion – Differential	50	— ⁽³⁾	Clip – Differential Clutch Retainer
24	34394	Gear – Differential (std)	51	39697	Cap Screw
			52	38116	Gasket
			53	—	Bolt – Axle Shaft (semi-float)
					Collapsible Spacer

- (1) See "Bill of Material Table" on next page
(2) See "Variable Parts Table" within this section
(3) Contact Vehicle Manufacturer
(4) Not Sold Separately

Dodge Model 60 /248 Rear Axles

Bill of Material Table

Axle			Axle Kits				Shaft & Joint Assy.	
Bill of Material	Diff. Type	Ratio	Ring Gear & Pinion Kit ⁽⁷⁾	Differential			Right Hand Shaft Assy.	Left Hand Shaft Assy.
				Case Assy. Kit ⁽⁸⁾	Case Kit	Inner Parts Kit		
1979 B-300 Maxivan HD								
603920-1	Standard	4.10	706033-3X	706036X	706040X	706043X	35953-5	35953-6
603920-2	Standard	3.73	706033-2X	706036X	706040X	706043X	35953-5	35953-6
603920-3	Trac Lok	3.73	706033-2X	708013	708014	707084X	35953-5	35953-6
603920-4	Trac Lok	4.10	706033-3X	708013	708014	707084X	35953-5	35953-6
1979 D-200 & BD-600								
603917-1	Standard	3.54	706033-1X	706036X	706040X	706043X	43965-2	43965-3
603917-2	Standard	4.10	706033-3X	706036X	706040X	706043X	43965-2	43965-3
603917-3	Trac Lok	4.10	706033-3X	708013	708014	707084X	43965-2	43965-3
603917-4	Standard	4.10	706033-3X	706036X	706040X	706043X	43965-2	43965-3
1979 D-200 & W-200 HD								
603647-2	Standard	4.10	706033-3X	706036X	706040X	706043X	35953	35953
603647-3	Trac Lok	4.10	706033-3X	708013	708014	707084X	35953	35953
603647-6	Trac Lok	4.10	706033-3X	708013	708014	707084X	35953	35953
603647-7	Standard	4.10	706033-3X	706036X	706040X	706043X	35953	35953
1979 MD-300 Dual Wheel HD								
603919-1	Standard	4.10	706033-3X	706036X	706040X	706043X	35953-3	35953-4
603919-2	Standard	4.10	706033-3X	706036X	706040X	706043X	35953-3	35953-4
1979 Rail Maintenance								
603831-1	Trac Lok	4.10	706033-3X	708013	708014	707084X	38378-5	38378-5
1979-84 High Performance Racing Axle (semi-float)								
603971-1	Standard	5.13	706033-9X	706182X	706041X	706702X	71017-1X	71017-2X
603971-2	Powr Lok	5.13	706033-9X	706323X	706175X	706324X	71017-1X	71017-2X
603972-1	Standard	5.38	706033-10X	706182X	706041X	706702X	71017-3X	71017-4X
603972-2	Powr Lok	5.38	706033-10X	706323X	706175X	706324X	71017-3X	71017-4X
1980-82 D-200 & W-200 HD								
603992-1	Trac Lok	4.10	706033-3X	708013	708014	707084X	35953	35953
603992-2	Standard	4.10	706033-3X	706036X	706040X	706043X	35953	35953
603992-3	Standard	4.10	706033-3X	706036X	706040X	706043X	35953	35953
603992-4	Standard	4.10	706033-3X	706036X	706040X	706043X	35953	35953
603992-5	Standard	4.10	706033-3X	708013	708014	707084X	35953	35953
603992-6	Standard	4.56	706033-4X	706037X	706041X	706043X	35953	35953
1980-84 C-300 & B-300 MB-300 HD								
603990-1	Standard	3.54	706033-1X	706036X	706040X	706043X	43965-2	43965-3
603990-2	Standard	4.10	706033-3X	706036X	706040X	706043X	43965-2	43965-3
603990-3	Trac Lok	3.54	706033-1X	708013	708014	707084X	43965-2	43965-3
603990-4	Trac Lok	4.10	706033-3X	708013	708014	707084X	43965-2	43965-3
1980-84 MB-300 Dual Wheel HD								
603993-1	Standard	4.10	706033-3X	706036X	706040X	706043X	35953-3	35953-4
603993-2	Standard	4.56	706033-4X	706037X	706041X	706043X	35953-3	35953-4
1980-88 1/2 D-200 W-200 & D-600								
603989-1	Standard	4.10	706033-3X	706036X	706040X	706043X	43965-1	43965-1
603989-2	Standard	3.54	706033-1X	706036X	706040X	706043X	43965-1	43965-1
603989-3	Trac Lok	3.54	706033-1X	708013	708014	707084X	43965-1	43965-1
603989-4	Trac Lok	4.10	706033-3X	708013	708014	707084X	43965-1	43965-1
603989-5	Standard	4.56	706033-4X	706037X	706041X	706043X	43965-1	43965-1
603989-6	Standard	3.54	706033-1X	706036X	706040X	706043X	43965-1	43965-1
603989-7	Standard	3.54	706033-1X	706037X	706041X	706043X	43965-1	43965-1

(7) See Ring Gear & Pinion Kits in XGI Catalog for ratio & tooth combinations.

(8) See Differential Case Assy Kits in XGI Catalog for spline data & ratios.

Dodge Model 60 /248 Rear Axles

Bill of Material Table

Axle			Axle Kits				Shaft & Joint Assy.	
Bill of Material	Diff. Type	Ratio	Ring Gear & Pinion Kit ⁽⁷⁾	Differential			Right Hand Shaft Assy.	Left Hand Shaft Assy.
				Case Assy. Kit ⁽⁸⁾	Case Kit	Inner Parts Kit		
1980-88 1/2 B-300 Maxivan HD								
603994-1	Standard	3.73	706033-2X	706036X	706040X	706043X	35953-5	35953-6
603994-2	Trac Lok	3.73	706033-2X	708013	708014	707084X	35953-5	35953-6
603994-3	Standard	4.10	706033-3X	706036X	706040X	706043X	35953-5	35953-6
603994-4	Trac Lok	4.10	706033-3X	708013	708014	707084X	35953-5	35953-6
603994-5	Trac Lok	4.10	706033-3X	708013	708014	707084X	35953-5	35953-6
1983-84 D-300 HD								
605082-1	Standard	4.10	706033-3X	706036X	706040X	706043X	43965-1	43965-1
605082-2	Trac Lok	4.10	706033-3X	708013	708014	707084X	43965-1	43965-1
605082-3	Standard	3.54	706033-1X	706036X	706040X	706043X	43965-1	43965-1
1985-85 1/2 D-200 & BD-600								
605224-1	Standard	4.10	706033-3X	706036X	706040X	706043X	43965-1	43965-1
605224-2	Trac Lok	4.10	706033-3X	708013	708053	707084X	43965-1	43965-1
605224-3	Standard	4.10	706033-3X	706036X	706040X	706043X	43965-1	43965-1
1985-88 1/2 B-300 (Van)								
605222-1	Standard	3.54	706033-1X	706036X	706040X	706043X	43965-1	43965-1
605222-2	Trac Lok	3.54	706033-1X	708013	708014	707084X	43965-1	43965-1
605222-3	Standard	4.10	706033-3X	706036X	706040X	706043X	43965-1	43965-1
605222-4	Trac Lok	4.10	706033-3X	708013	708014	707084X	43965-1	43965-1
1985-88 1/2 D-200 HD & D-300 HD								
605225-1	Standard	4.10	706033-3X	706036X	706040X	706043X	43965-1	43965-1
605225-2	Trac Lok	4.10	706033-3X	708013	708014	707084X	43965-1	43965-1
605225-3	Standard	4.10	706033-3X	706036X	706040X	706043X	43965-1	43965-1
605225-4	Trac Lok	4.10	706033-3X	708013	708014	707084X	43965-1	43965-1
1989 B-300 Maxivan HD								
605441-1	Standard	4.09	706033-13X	708010	708011	706043X	35953-5	35953-6
605441-2	Trac Lok	4.09	706033-13X	708013	708014	707084X	35953-5	35953-6
1989-90 1/2 D-300 & D-700 HD - w/ABS								
605368-1	Standard	4.10	706033-3X	708010	708011	706043X	35953	35953
605368-2	Trac Lok	4.10	706033-3X	708013	708014	707084X	35953	35953
605368-3	Standard	4.56	706033-4X	707174X	707175X	706043X	35953	35953
1989-93 1/2 D-200 HD & D-600 H.D - w/ABS								
605370-1	Standard	4.09	706033-13X	708010	708011	706043X	43965-1	43965-1
605370-2	Trac Lok	4.09	706033-13X	708013	708014	707084X	43965-1	43965-1
605370-3	Standard	4.09	706033-13X	708010	708011	706043X	43965-1	43965-1
605370-4	Trac Lok	4.09	706033-13X	708013	708014	707084X	43965-1	43965-1
605370-5	Standard	4.09	706033-13X	708010	708011	706043X	43965-1	43965-1
605370-6	Trac Lok	4.09	706033-13X	708013	708014	707084X	43965-1	43965-1
605370-7	Standard	4.09	706033-13X	708010	708011	706043X	43965-1	43965-1
605370-8	Trac Lok	4.09	706033-13X	708013	708014	707084X	43965-1	43965-1
605371-1	Standard	3.54	706033-1X	708010	708011	706043X	43965-1	43965-1
605371-2	Trac Lok	3.54	706033-1X	708013	708014	707084X	43965-1	43965-1
1989-94 1/2 B-300 HD - w/ABS								
605440-1	Standard	4.09	706033-13X	708010	708011	706043X	43965-2	43965-3
605440-2	Trac Lok	4.09	706033-13X	708013	708014	707084X	43965-2	43965-3
605440-3	Standard	4.09	706033-13X	708010	708011	706043X	43965-2	43965-3
605440-4	Trac Lok	4.09	706033-13X	708013	708014	707084X	43965-2	43965-3

(7) See Ring Gear & Pinion Kits in XGI Catalog for ratio & tooth combinations.

(8) See Differential Case Assy Kits in XGI Catalog for spline data & ratios.

Dodge Model 60 /248 Rear Axles

Bill of Material Table

Axle			Axle Kits				Shaft & Joint Assy.	
Bill of Material	Diff. Type	Ratio	Ring Gear & Pinion Kit ⁽⁷⁾	Differential			Right Hand Shaft Assy.	Left Hand Shaft Assy.
				Case Assy. Kit ⁽⁸⁾	Case Kit	Inner Parts Kit		
1991-94 B-300 Maxivan - w/ABS								
605516-1	Standard	4.09	706033-13X	708010	708011	706043X	43965-2	43965-3
605516-2	Trac Lok	4.09	706033-13X	708013	708014	707084X	43965-2	43965-3
605516-3	Standard	4.09	706033-13X	708010	708011	706043X	43965-2	43965-3
1991-95 1/2 D-300 & D-700 HD - w/ABS								
605517-1	Standard	4.09	706033-13X	708010	708011	706043X	43965-1	43965-1
605517-2	Trac Lok	4.09	706033-13X	708013	708014	707084X	43965-1	43965-1
605517-3	Standard	4.56	706033-4X	707174X	707175X	706043X	43965-1	43965-1
605517-4	Standard	4.09	706033-13X	708010	708011	706043X	43965-1	43965-1
605517-5	Trac Lok	4.09	706033-13X	708013	708014	707084X	43965-1	43965-1
605517-6	Standard	4.56	706033-4X	707174X	707175X	706043X	43965-1	43965-1
1994 1/2-97 1/2 B-300 Van - w/ABS								
605710-1	Standard	4.09	706033-13X	708010	708011	706043X	43965-2	43965-3
605710-2	Trac Lok	4.09	706033-13X	708013	708014	707084X	43965-2	43965-3
605711-1	Standard	4.09	706033-13X	708010	708011	706043X	43965-2	43965-3
605711-2	Trac Lok	4.09	706033-13X	708013	708014	707084X	43965-2	43965-3
1998 B-300 Van - w/ABS								
605871-1	Standard	4.09	708021-1	708010	708011	706043X	43965-2	43965-3
605965-1	Standard	4.09	708021-1	708010	708011	706043X	43965-2	43965-3
605965-2	Trac Lok	4.09	708021-1	708013	708014	707084X	43965-2	43965-3
606108-1	Standard	4.09	708021-1	707120X	707121X	706043X	43965-2	43965-3
606108-2	Trac Lok	4.09	708021-1	707090X	707123X	707084X	43965-2	43965-3
1998-98 1/2 B-300 Van - w/ABS								
606058-1	Standard	4.09	706033-13X	708010	708011	706043X	43965-2	43965-3
606058-2	Trac Lok	4.09	706033-13X	708013	708014	707084X	43965-2	43965-3
606059-1	Standard	4.09	706033-13X	708010	708011	706043X	43965-2	43965-3

(7) See Ring Gear & Pinion Kits in XGI Catalog for ratio & tooth combinations.

(8) See Differential Case Assy Kits in XGI Catalog for spline data & ratios.

Dodge Model 60 /248 Rear Axles Variable Parts Listing

Kits & Parts - Use With All Applications							
Description & Item Number (Refer to "Exploded View" at the front of this section)			Bills of Material				
			603647	603831 ⁽¹⁰⁾	603917	603919	603920
1	End Yoke Assembly (inc 9)	10	— ⁽⁹⁾	— ⁽⁹⁾	— ⁽⁹⁾	— ⁽⁹⁾	— ⁽¹¹⁾
2	KIT – Carrier Cover	-	707183X	707183X	707183X	707183X	707183X
3	Carrier Cover	13	43788	43788	43788	43788	43788
4	Bolt – Drive Gear (qty 12)	22	30266	30266	30266	30266	30266
5	Seal – Hub	32	43146	—	40709	—	43146
6	Spindle Nut	36	35270	—	35270	35270	35270
7	Lockwasher / Locking Wedge	37	35269	—	35269	35269	35269
			603971 603972	603989 ⁽¹⁰⁾	603990	603992 ⁽¹⁰⁾	603993
1	End Yoke Assembly (inc 9)	10	—	— ⁽⁹⁾	— ⁽⁹⁾	— ⁽⁹⁾	— ⁽¹¹⁾
2	KIT – Carrier Cover	-	707183X	707183X	707183X	707183X	707183X
3	Carrier Cover	13	43788	43788	43788	43788	43788
4	Bolt – Drive Gear (qty 12)	22	30266	30266	30266	30266	30266
5	Seal – Hub	32	—	—	40709	—	—
6	Spindle Nut	36	—	—	39695	—	39695
7	Lockwasher / Locking Wedge	37	—	—	41373	—	41373
			603994 ⁽¹⁰⁾	605082	605222 ⁽¹⁰⁾	605224 ⁽¹⁰⁾ 605225 ⁽¹⁰⁾	605368
1	End Yoke Assembly (inc 9)	10	— ⁽⁹⁾	— ⁽¹¹⁾	— ⁽¹¹⁾	— ⁽⁹⁾	— ⁽¹¹⁾
2	KIT – Carrier Cover	-	707183X	707183X	707183X	707183X	707182X
3	Carrier Cover	13	43788	43788	43788	43788	43787
4	Bolt – Drive Gear (qty 12)	22	30266	30266	30266	30266	40638
5	Seal – Hub	32	—	40709	—	—	43146
6	Nut – Spindle	36	—	39695	—	—	39695
7	Lockwasher / Locking Wedge	37	—	41373	—	—	41373
			605370 605371	605440	605441	605516	605517
1	End Yoke Assembly (inc 9)	10	— ⁽⁹⁾	— ⁽¹¹⁾	— ⁽⁹⁾	— ⁽⁹⁾	— ⁽⁹⁾
2	KIT – Carrier Cover	-	707182X	707183X	707183X	707183X	707182X
3	Cover – Carrier	13	43787	43788	43788	43788	43788
4	Bolt – Drive Gear (qty 12)	22	43146	40638	40638	40638	40638
5	Seal – Hub	32	40709	40709	43146	43146	43146
6	Spindle Nut	36	39695	39695	39695	39695	39695
7	Lockwasher / Locking Wedge	37	41373	41373	41373	41373	41373
			605710	605711 605871	605965	606058	606059 606108
1	End Yoke Assembly (inc 9)	10	— ⁽⁹⁾	3-4-11891-1X	— ⁽⁹⁾	2-4-7681-1X	3-4-11891-1X
2	KIT – Carrier Cover	-	707183X	707183X	707183X	707183X	707183X
3	Carrier Cover	13	43787	43788	43788	43788	43788
4	Bolt – Drive Gear (qty 12)	22	40638	40638	40638	40638	40638
5	Seal – Hub	32	40709	47507	35313	40709	47507
6	Spindle Nut	36	47163	47163	47163	47163	47163
7	Lockwasher / Locking Wedge	37	46545	46545	46545	46545	46545

(9) Must identify yoke series used in vehicle; Service 7260 Series with 1310 Series using 2-4-8391-1X, 5-353X and 2-70-18X. Service 7290 Series with 2-4-7681-1X. Service 1410 Series with 3-4-11891-1X.

(10) Contact vehicle manufacturer for all wheel end components

(11) 7260 Series yoke used in vehicle. Service 1310 Series using 2-4-8391-1X, 5-353X and 2-70-18X.

Dodge / Chrysler 1994-1998 1/2

**Model 60 /248 Rear
Axles for**

D2500, W2500 Ram

Dodge Model 60 /248 Rear Axles - Ram Exploded View

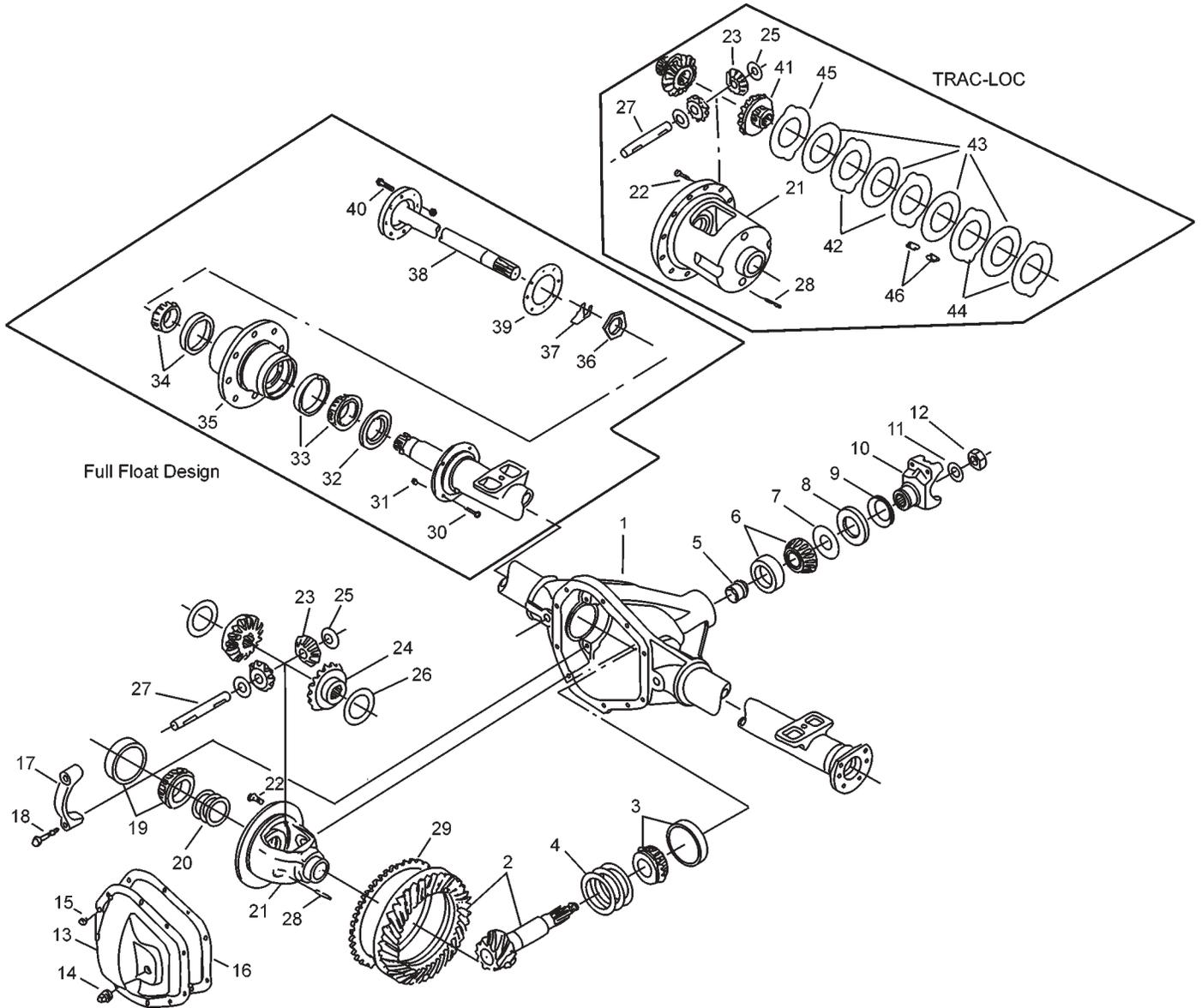

Dodge Model 60 /248 Rear Axles - Ram

Parts Listing



ITEM NO.	PART NUMBER	DESCRIPTION	ITEM NO.	PART NUMBER	DESCRIPTION
1	— ⁽³⁾	Housing – Axle Service	23	34367	Pinion – Differential
2	— ⁽¹⁾	Drive Pinion & Gear Assembly	24	34394	Gear – Differential (std)
3	706046X	KIT – Inner Pinion Bearing	25	34730	Thrustwasher – Differential Pinion
4	701126X	PKG – Inner Pinion Shim	26	34729	Thrustwasher – Differential Gear (std)
5	45658	Collapsible Spacer	27	30263	Shaft – Differential
6	706045X	KIT – Outer Pinion Bearing	28	44810	Lock – Differential Shaft
7	42737	Thrustwasher	29	42928	Tone Ring (ABS)
8	42449	Seal – Pinion Oil	30	— ⁽³⁾	Bolt – Brake Mounting
9	34592	Slinger – End Yoke	31	— ⁽³⁾	Nut – Brake Mounting
10	3-4-11891-1X	End Yoke Assembly (inc 9)	32	47507	Seal – Hub
11	44167	Washer – Pinion Nut	33	— ⁽³⁾	KIT – Inner Wheel Bearing
12	30271	Pinion Nut	34	— ⁽³⁾	KIT – Outer Wheel Bearing
	— ⁽²⁾	KIT – Carrier Cover	35	— ⁽³⁾	Wheel Hub
		(inc items 13, 14, 15)	36	— ⁽²⁾	Spindle Nut
13	— ⁽⁴⁾	Carrier Cover	37	46545	Locking Wedge
14	43180	Plug – Carrier Cover	38	— ⁽¹⁾	Shaft – Axle Flanged Drive
15	34822	Bolt – Carrier Cover (qty 10)	39	39697	Gasket
16	34687	Gasket – Carrier Cover	40	— ⁽³⁾	Cap Screw
	38615	RTV Silicone Sealant	41	35803	Gear – Differential (t/l)
17	— ⁽³⁾	Differential Bearing Cap		707083X	KIT – Disc & Plate (t/l)
18	48632-1	Bolt – Differential Bearing Cap	42	— ⁽⁴⁾	Plate – Differential Pressure
19	706047X	KIT – Differential Bearing	43	— ⁽⁴⁾	Disc – Differential
20	708012	PKG – Differential Brg Shim (inc 16)	44	— ⁽⁴⁾	Plate – Diff (selective thickness)
21	— ⁽¹⁾	Case – Differential	45	— ⁽⁴⁾	Plate – Preload Spacer
22	40638	Bolt – Drive Gear (qty 12)	46	40835	Clip – Differential Clutch Retainer

- (1) See "Bill of Material Table" on next page
- (2) See "Variable Parts Table" below
- (3) Contact Vehicle Manufacturer
- (4) Not Sold Separately

Variable Parts Listing

Kits & Parts - Use With All Applications							
Description & Item Number (Refer to "Exploded View" on previous page)			Bills of Material				
			605585	605586 605633	605634	605784 605793	605794
1	KIT – Carrier Cover	-	707354X	707353X	707354X	707353X	707354X
2	Spindle Nut	36	39695	39695	39695	47163	47163
			605898	605899	605907	605908	605978
1	KIT – Carrier Cover	-	707353X	707354X	707353X	707354X	707353X
2	Spindle Nut	36	47163	47163	47163	47163	47163
			605979	605987	605988 606054 606062		
1	KIT – Carrier Cover	-	707354X	707353X	707354X		
2	Nut – Spindle	36	47163	47163	47163		

Dodge Model 60 /248 Rear Axles - Ram

Bill of Material Table

Axle			Axle Kits				Shaft & Joint Assy.	
Bill of Material	Diff. Type	Ratio	Ring Gear & Pinion Kit ⁽⁷⁾	Differential			Right Hand Shaft Assy.	Left Hand Shaft Assy.
				Case Assy. Kit ⁽⁸⁾	Case Kit	Inner Parts Kit		
1994-95 1/2 D2500								
605585-1	Standard	4.10	708009-2	708010	708011	706043X	43965-4	43965-4
605585-2	Trac Lok	4.10	708009-2	708013	708014	707084X	43965-4	43965-4
605585-5	Standard	3.55	708009-1	708010	708011	706043X	43965-4	43965-4
605585-6	Trac Lok	3.55	708009-1	708013	708014	707084X	43965-4	43965-4
605585-7	Standard	3.55	708009-1	708010	708011	706043X	43965-4	43965-4
605585-8	Trac Lok	4.10	708009-2	708013	708014	707084X	43965-4	43965-4
605633-1	Standard	3.55	708009-1	708010	708011	706043X	43965-4	43965-4
605633-2	Trac Lok	3.55	708009-1	708013	708014	707084X	43965-4	43965-4
605633-3	Standard	4.10	708009-2	708010	708011	706043X	43965-4	43965-4
605633-4	Trac Lok	4.10	708009-2	708013	708014	707084X	43965-4	43965-4
605633-5	Standard	3.55	708009-1	708010	708011	706043X	43965-4	43965-4
605633-6	Trac Lok	4.10	708009-2	708013	708014	707084X	43965-4	43965-4
1994-95 1/2 W2500								
605586-1	Standard	3.55	708009-1	708010	708011	706043X	43965-4	43965-4
605586-2	Trac Lok	3.55	708009-1	708013	708014	707084X	43965-4	43965-4
605586-3	Standard	4.10	708009-2	708010	708011	706043X	43965-4	43965-4
605586-4	Trac Lok	4.10	708009-2	708013	708014	707084X	43965-4	43965-4
605586-7	Standard	3.55	708009-1	708010	708011	706043X	43965-4	43965-4
605586-8	Trac Lok	4.10	708009-2	708013	708014	707084X	43965-4	43965-4
605634-1	Standard	3.55	708009-1	708010	708011	706043X	43965-4	43965-4
605634-2	Trac Lok	3.55	708009-1	708013	708014	707084X	43965-4	43965-4
605634-3	Standard	4.10	708009-2	708010	708011	706043X	43965-4	43965-4
605634-4	Trac Lok	4.10	708009-2	708013	708014	707084X	43965-4	43965-4
605634-5	Standard	3.55	708009-1	708010	708011	706043X	43965-4	43965-4
605634-6	Trac Lok	4.10	708009-2	708013	708014	707084X	43965-4	43965-4
1996 W2500								
605899-1	Standard	3.55	708009-1	707120X	707121X	706043X	43965-4	43965-4
605899-2	Trac Lok	4.10	708009-2	707090X	707123X	707084X	43965-4	43965-4
1996-96 1/2 D2500								
605784-1	Standard	3.55	708009-1	708010	708011	706043X	43965-4	43965-4
605784-2	Trac Lok	4.10	708009-2	708013	708014	707084X	43965-4	43965-4
605793-1	Standard	3.55	708009-1	708010	708011	706043X	43965-4	43965-4
605793-2	Trac Lok	4.10	708009-2	708013	708014	707084X	43965-4	43965-4
1996 1/2 W2500								
605794-1	Standard	3.55	708009-1	708010	708011	706043X	43965-4	43965-4
605794-2	Trac Lok	4.10	708009-2	708013	708014	707084X	43965-4	43965-4
1997-97 1/2 D2500								
605898-1	Standard	3.55	708009-1	708010	708011	706043X	43965-4	43965-4
605898-2	Trac Lok	4.10	708009-2	708013	708014	707084X	43965-4	43965-4
605907-1	Standard	3.55	708009-1	708010	708011	706043X	43965-4	43965-4
605907-2	Trac Lok	4.10	708009-2	708013	708014	707084X	43965-4	43965-4
1997-97 1/2 W2500								
605908-1	Standard	3.55	708009-1	708010	708011	706043X	43965-4	43965-4
605908-2	Trac Lok	4.10	708009-2	708013	708014	707084X	43965-4	43965-4

(7) See Ring Gear & Pinion Kits in XGI Catalog for ratio & tooth combinations.

(8) See Differential Case Assy Kits in XGI Catalog for spline data & ratios.

Dodge Model 60 /248 Rear Axles - Ram

Bill of Material Table

Axle			Axle Kits				Shaft & Joint Assy.	
Bill of Material	Diff. Type	Ratio	Ring Gear & Pinion Kit ⁽⁷⁾	Differential			Right Hand Shaft Assy.	Left Hand Shaft Assy.
				Case Assy. Kit ⁽⁸⁾	Case Kit	Inner Parts Kit		
1997 1/2 W2500								
606054-1	Standard	3.55	708009-1	708010	708011	706043X	43965-4	43965-4
606054-2	Trac Lok	4.10	708009-2	708013	708014	707084X	43965-4	43965-4
1998 W2500								
605979-1	Standard	3.55	708009-1	707120X	707121X	706043X	43965-4	43965-4
605979-2	Trac Lok	4.10	708009-2	707090X	707123X	707084X	43965-4	43965-4
1998-98 1/2 D2500								
605978-1	Standard	3.55	708009-1	708010	708011	706043X	43965-4	43965-4
605978-2	Trac Lok	4.10	708009-2	708013	708014	707084X	43965-4	43965-4
605987-1	Standard	3.55	708009-1	708010	708011	706043X	43965-4	43965-4
605987-2	Trac Lok	4.10	708009-2	708013	708014	707084X	43965-4	43965-4
1998-98 1/2 W2500								
605988-1	Standard	3.55	708009-1	708010	708011	706043X	43965-4	43965-4
605988-2	Trac Lok	4.10	708009-2	708013	708014	707084X	43965-4	43965-4
606062-1	Standard	3.55	708009-1	708010	708011	706043X	43965-4	43965-4
606062-2	Trac Lok	4.10	708009-2	708013	708014	707084X	43965-4	43965-4

(7) See Ring Gear & Pinion Kits in XGI Catalog for ratio & tooth combinations.

(8) See Differential Case Assy Kits in XGI Catalog for spline data & ratios.

Dodge / Chrysler 1979-1993 1/2

Model 70 /267 Rear Axles for

CB-300 HD, CB-400

D-300, D-400, D-500,

D-600, D-700

M-300, M-400

M-500

MB-400

W-350

WM-300

Front Section Motor Home

Israel Aircraft

Dodge Model 70 /267 Rear Axles Exploded View

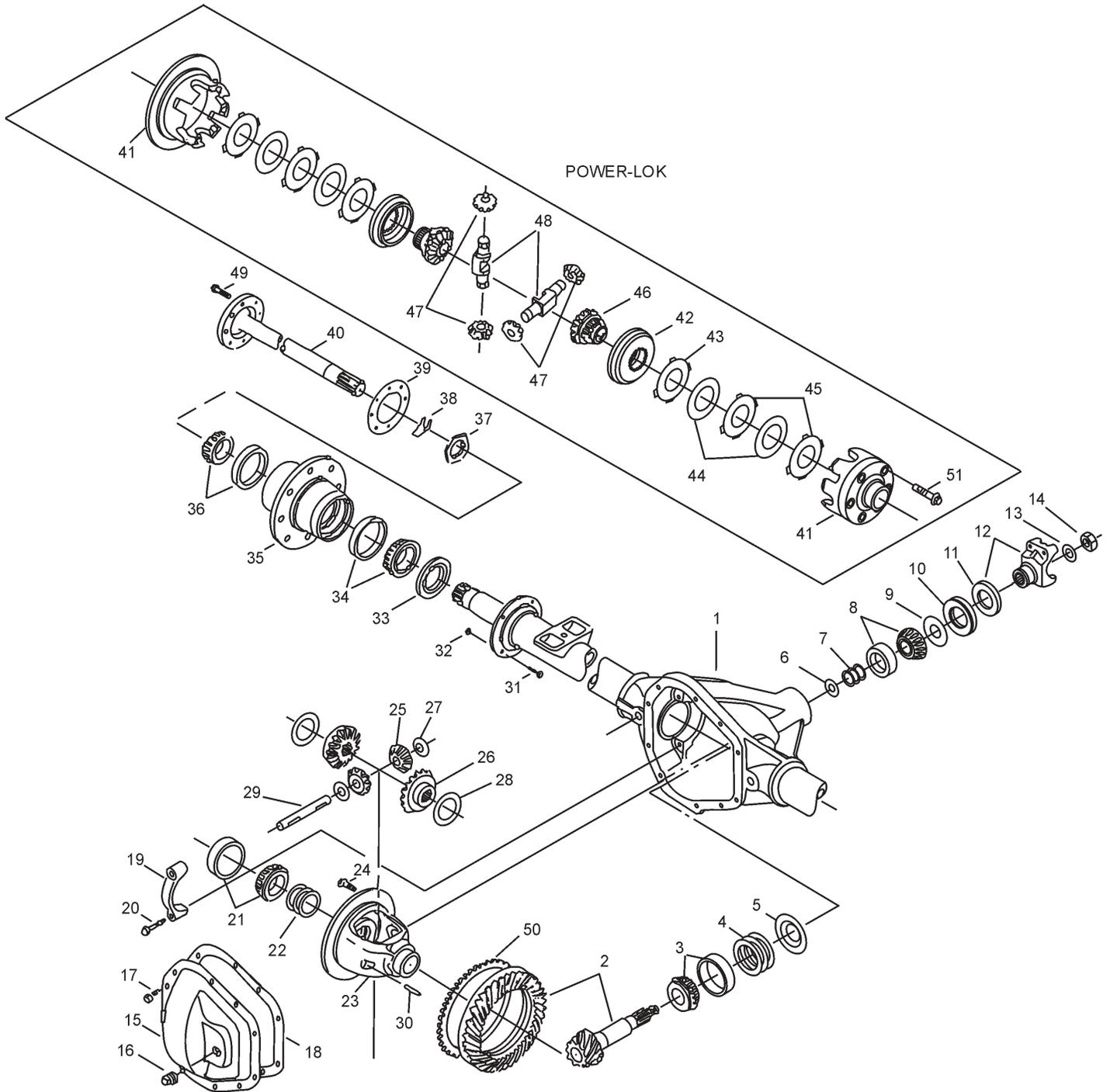

Shown: One Piece Case - Standard

Dodge Model 70 /267 Rear Axles

Parts Listing

ITEM NO.	PART NUMBER	DESCRIPTION	ITEM NO.	PART NUMBER	DESCRIPTION
1	— ⁽³⁾	Housing – Axle Service	24	— ⁽²⁾	Bolt – Drive Gear (qty 12)
2	— ⁽¹⁾	Drive Pinion & Gear Assembly	25	35080	Pinion – Differential (std)
3	— ⁽²⁾	KIT – Inner Pinion Bearing	26	— ⁽²⁾	Gear – Differential (std)
	— ⁽²⁾	PKG – Diff & Pinion Bearing Shim (inc items 4, 7, 13, 14, 22)	27	35082	Thrustwasher – Diff Pinion (std)
	— ⁽²⁾	PKG – Pinion Bearing Shim (inc items 4, 7, 13, 14, 18)	28	34729	Thrustwasher – Diff Gear (std)
4	— ⁽⁴⁾	Inner Pinion Shims (see shim packages)	29	46640	Shaft – Differential (std)
5	— ⁽²⁾	Baffle – Pinion Bearing	30	47024	Lock – Differential Shaft
6	— ⁽²⁾	Flat Spacer – Outer Pinion	31	— ⁽³⁾	Bolt – Brake Mounting
7	— ⁽⁴⁾	Outer Pinion Shims (see shim packages)	32	— ⁽³⁾	Nut – Brake Mounting
8	706045X	KIT – Outer Pinion Bearing	33	39693	Seal – Hub
9	42737	Thrustwasher – Bearing	34	— ⁽³⁾	KIT – Inner Wheel Bearing
10	42449	Seal – Pinion Oil	35	— ⁽³⁾	Wheel Hub
11	34592	Slinger – End Yoke	36	— ⁽³⁾	KIT – Outer Wheel Bearing
12	— ⁽²⁾	End Yoke Assembly (inc 11)	37	39695	Spindle Nut
13	— ⁽²⁾	Washer – Pinion Nut	38	41373	Locking Wedge
14	30271	Pinion Nut	39	39697	Gasket – Axle Shaft
	— ⁽²⁾	KIT – Carrier Cover	40	— ⁽¹⁾	Shaft – Axle Flange Drive
15	— ⁽²⁾	Carrier Cover	41	— ⁽¹⁾	Case – Differential (p/l)
16	36472	Plug – Carrier Cover	42	42522	Ring – Differential Gear
17	34822	Bolt – Carrier Cover (qty 10)	43	707075X	KIT – Disc & Plate (p/l)
18	34687	Gasket – Carrier Cover	44	— ⁽⁴⁾	Plate – Differential
19	— ⁽³⁾	Differential Bearing Cap	45	— ⁽⁴⁾	Disc – Differential Dished
20	48632-1	Bolt – Differential Bearing Cap	46	— ⁽²⁾	Plate – Differential
21	— ⁽²⁾	KIT – Differential Bearing	47	31040	Gear – Differential (p/l)
22	— ⁽²⁾	PKG – Diff Bearing Shim (inc 18)	48	31041	Pinion – Differential (p/l)
23	— ⁽¹⁾	Case – Differential (std)	49	43124	Shaft – Differential (p/l)
			50	42929	Screw – Self Locking
			51	41610-1	Tone Ring (ABS)
					Flange Head Screw

- (1) See "Bill of Material Table" on next page
(2) See "Variable Parts Table" within this section
(3) Contact Vehicle Manufacturer
(4) Not Sold Separately

Dodge Model 70 /267 Rear Axles

Bill of Material Table

Axle			Axle Kits				Shaft & Joint Assy.	
Bill of Material	Diff. Type	Ratio	Ring Gear & Pinion Kit ⁽⁷⁾	Differential			Right Hand Shaft Assy.	Left Hand Shaft Assy.
				Case Assy. Kit ⁽⁸⁾	Case Kit	Inner Parts Kit		
1979 D-300/400 & W-300/400								
603695-1	Standard	4.56	706999-6X	706052X	706056X	706058X	35091-4	35091-4
603695-2	Standard	4.88	706999-8X	706052X	706056X	706058X	35091-4	35091-4
603695-3	Powr Lok	4.56	706999-6X	706050X	706054X	706057X	35091-4	35091-4
603695-4	Powr Lok	4.88	706999-8X	706050X	706054X	706057X	35091-4	35091-4
603695-5	Standard	4.10	706999-4X	706051X	706055X	706058X	35091-4	35091-4
603695-6	Powr Lok	4.10	706999-4X	706049X	706053X	706057X	35091-4	35091-4
603695-7	Standard	7.17	706999-14X	706052X	706056X	706058X	35091-4	35091-4
603695-8	Standard	5.86	706999-10X	706052X	706056X	706058X	35091-4	35091-4
603695-9	Standard	4.10	706999-4X	706051X	706055X	706058X	35091-4	35091-4
603695-10	Standard	4.88	706999-8X	706052X	706056X	706058X	35091-4	35091-4
603695-11	Powr Lok	4.88	706999-8X	706050X	706054X	706057X	35091-4	35091-4
603695-12	Standard	4.56	706999-6X	706052X	706056X	706058X	35091-4	35091-4
603695-13	Standard	4.88	706999-8X	706052X	706056X	706058X	35091-4	35091-4
603695-14	Powr Lok	4.56	706999-6X	706050X	706054X	706057X	35091-4	35091-4
603695-15	Powr Lok	4.88	706999-8X	706050X	706054X	706057X	35091-4	35091-4
603695-16	Standard	4.10	706999-4X	706051X	706055X	706058X	35091-4	35091-4
603695-17	Powr Lok	4.10	706999-4X	706049X	706053X	706057X	35091-4	35091-4
603695-18	Standard	7.17	706999-14X	706052X	706056X	706058X	35091-4	35091-4
603695-19	Standard	5.86	706999-10X	706052X	706056X	706058X	35091-4	35091-4
603695-22	Powr Lok	4.88	706999-8X	706050X	706054X	706057X	35091-4	35091-4
1979 D-300 Sweptline								
603696-1	Standard	4.10	706999-4X	706051X	706056X	706058X	35091-10	35091-10
603696-2	Powr Lok	4.10	706999-4X	706049X	706053X	706057X	35091-10	35091-10
603696-3	Standard	4.10	706999-4X	706051X	706055X	706058X	35091-10	35091-10
603696-4	Standard	4.10	706999-4X	706051X	706055X	706058X	35091-10	35091-10
603696-5	Powr Lok	4.10	706999-4X	706049X	706053X	706057X	35091-10	35091-10
603696-6	Standard	4.10	706999-4X	706051X	706055X	706058X	35091-10	35091-10
1979 M-300 & M-400 Motor Home (2 pc. std. case)								
603651-1	Standard	4.88	706999-8X	706082X	706084X	706058X	35091-1	35091-1
603651-2	Standard	4.56	706999-6X	706082X	706084X	706058X	35091-1	35091-1
603651-3	Standard	4.88	706999-8X	706082X	706084X	706058X	35091-1	35091-1
603651-4	Standard	4.56	706999-6X	706082X	706084X	706058X	35091-1	35091-1
1979 M-500 Motor Home								
603652-6	Standard	4.56	706999-6X	706065X	706069X	706058X	35103-1	35103-1
603652-8	Standard	4.56	706999-6X	706065X	706069X	706058X	35103-1	35103-1
603652-9	Powr Lok	5.86	706999-10X	706063X	706067X	706057X	35103-1	35103-1
603652-15	Standard	4.56	706999-6X	706065X	706069X	706058X	35103-1	35103-1
603652-17	Powr Lok	5.86	706999-10X	706063X	706067X	706057X	35103-1	35103-1
1979 WM 300								
603841-1	Standard	4.88	706999-8X	706052X	706056X	706058X	35091-19	35091-20

(7) See Ring Gear & Pinion Kits in XGI Catalog for ratio & tooth combinations.

(8) See Differential Case Assy Kits in XGI Catalog for spline data & ratios.

Dodge Model 70 /267 Rear Axles

Bill of Material Table

Axle			Axle Kits				Shaft & Joint Assy.	
Bill of Material	Diff. Type	Ratio	Ring Gear & Pinion Kit ⁽⁷⁾	Differential			Right Hand Shaft Assy.	Left Hand Shaft Assy.
				Case Assy. Kit ⁽⁸⁾	Case Kit	Inner Parts Kit		
1979-83 P-300								
603653-1	Standard	4.10	706999-4X	706051X	706055X	706058X	35091-1	35091-1
603653-2	Standard	4.56	706999-6X	706052X	706056X	706058X	35091-1	35091-1
603653-3	Standard	4.88	706999-8X	706052X	706056X	706058X	35091-1	35091-1
603653-4	Standard	5.86	706999-10X	706052X	706056X	706058X	35091-1	35091-1
603653-5	Standard	4.10	706999-4X	706051X	706055X	706058X	35091-1	35091-1
603653-6	Standard	4.56	706999-6X	706052X	706056X	706058X	35091-1	35091-1
603653-7	Standard	4.88	706999-8X	706052X	706056X	706058X	35091-1	35091-1
603653-8	Standard	5.86	706999-10X	706052X	706056X	706058X	35091-1	35091-1
1979-83 WM-300								
603955-1	Standard	4.88	706999-8X	706052X	706056X	706058X	35091-19	35091-20
603955-2	Standard	4.88	706999-8X	706052X	706056X	706058X	35091-19	35091-20
1979-84 CB-300 HD & MB-400 HD								
603918-1	Standard	4.10	706999-4X	706051X	706055X	706058X	35091-11	35091-12
603918-3	Standard	4.10	706999-4X	706051X	706055X	706058X	35091-11	35091-12
1979-84 CB-400 & MB-400								
603916-1	Standard	4.10	706999-4X	706064X	706068X	706058X	35091-17	35091-18
603916-2	Standard	4.56	706999-6X	706065X	706069X	706058X	35091-17	35091-18
603916-3	Standard	4.10	706999-4X	706064X	706068X	706058X	35091-17	35091-18
1980-83 M-300 & M-400 Motor Home (2 pc. std. case)								
603997-1	Standard	4.88	706999-8X	706052X	706056X	706058X	35091-1	35091-1
603997-2	Standard	4.56	706999-6X	706052X	706056X	706058X	35091-1	35091-1
603997-3	Standard	4.88	706999-8X	706052X	706056X	706058X	35091-1	35091-1
1980-83 M-500 Motor Home								
603998-1	Standard	4.88	706999-8X	706065X	706069X	706058X	35103-1	35103-1
603998-2	Standard	4.88	706999-8X	706065X	706069X	706058X	35103-1	35103-1
1980-84 D-300/400 & W-300/400								
603995-1	Standard	4.56	706999-6X	706052X	706056X	706058X	35091-4	35091-4
603995-2	Powr Lok	4.56	706999-6X	706050X	706054X	706057X	35091-4	35091-4
603995-3	Standard	4.56	706999-6X	706052X	706056X	706058X	35091-4	35091-4
603995-4	Standard	4.88	706999-8X	706052X	706056X	706058X	35091-4	35091-4
603995-5	Powr Lok	4.56	706999-6X	706050X	706054X	706057X	35091-4	35091-4
603995-6	No Spin	4.88	706999-8X	28284X	706084X	35683	35091-4	35091-4
603995-7	Standard	4.10	706999-4X	706051X	706055X	706058X	35091-4	35091-4
603995-8	Powr Lok	4.88	706999-8X	706050X	706054X	706057X	35091-4	35091-4
603995-9	Standard	4.56	706999-6X	706052X	706056X	706058X	35091-4	35091-4
603995-10	Powr Lok	4.56	706999-6X	706050X	706054X	706057X	35091-4	35091-4
603995-11	Standard	4.56	706999-6X	706052X	706056X	706058X	35091-4	35091-4
603995-12	Standard	4.88	706999-8X	706052X	706056X	706058X	35091-4	35091-4
603995-13	Powr Lok	4.56	706999-6X	706050X	706054X	706057X	35091-4	35091-4
603995-14	No Spin	4.88	706999-8X	28284X	706084X	35683	35091-4	35091-4
603995-15	Standard	4.10	706999-4X	706051X	706055X	706058X	35091-4	35091-4
603995-16	Powr Lok	4.88	706999-8X	706050X	706054X	706057X	35091-4	35091-4
1984-85 D-300/D-450 Sweptline & D-350 & W-350								
605192-1	Standard	4.10	706998-3X	706051X	706055X	706058X	35091-10	35091-10
605192-2	Standard	4.56	706998-4X	706052X	706056X	706058X	35091-10	35091-10
605192-3	Powr Lok	4.10	706998-3X	706049X	706053X	706057X	35091-10	35091-10

(7) See Ring Gear & Pinion Kits in XGI Catalog for ratio & tooth combinations.

(8) See Differential Case Assy Kits in XGI Catalog for spline data & ratios.

Dodge Model 70 /267 Rear Axles

Bill of Material Table

Axle			Axle Kits				Shaft & Joint Assy.	
Bill of Material	Diff. Type	Ratio	Ring Gear & Pinion Kit ⁽⁷⁾	Differential			Right Hand Shaft Assy.	Left Hand Shaft Assy.
				Case Assy. Kit ⁽⁸⁾	Case Kit	Inner Parts Kit		
1985 D-300								
605215-1	Standard	4.10	706998-3X	706051X	706055X	706058X	35091-10	35091-10
1985 D-300 & D-400 & D-700								
605214-1	Standard	4.56	706998-4X	706052X	706056X	706058X	35091-4	35091-4
605214-2	Powr Lok	4.56	706998-4X	706050X	706054X	706057X	35091-4	35091-4
605214-3	Standard	4.56	706998-4X	706052X	706056X	706058X	35091-4	35091-4
1985-88 1/2 Front Section Motor Home								
605235-1	Standard	4.10	706998-3X	706051X	706055X	706058X	35091-11	35091-12
1985-90 1/2 Israel Aircraft								
605158-1	Standard	4.88	706998-5X	706052X	706056X	706058X	35091-28	35091-28
605158-2	Powr Lok	4.88	706998-5X	706050X	706054X	706057X	35091-28	35091-28
1985 1/2 D-300 & D-400 & D-500 & D-600								
605269-1	Standard	4.56	706998-4X	706052X	706056X	706058X	35091-4	35091-4
605269-2	Powr Lok	4.56	706998-4X	706050X	706054X	706057X	35091-4	35091-4
605269-3	Standard	4.56	706998-4X	706052X	706056X	706058X	35091-4	35091-4
605270-1	Standard	4.10	706998-3X	706051X	706055X	706058X	35091-10	35091-10
605270-2	Standard	4.56	706998-4X	706052X	706056X	706058X	35091-10	35091-10
605270-3	Standard	4.56	706998-4X	706052X	706056X	706058X	35091-10	35091-10
605270-4	Powr Lok	4.10	706998-3X	706049X	706053X	706057X	35091-10	35091-10
605270-5	Powr Lok	4.56	706998-4X	706050X	706054X	706057X	35091-10	35091-10
1987-90 D-300 & D-700 - ABS								
605313-1	Standard	3.07	706998-13X	707128X	708017	706058X	35091-4	35091-4
605313-2	Powr Lok	3.07	706998-13X	707130X	708019	707074X	35091-4	35091-4
1987-90 1/2 D-200 & D-300 & D-600 & D-700 - ABS								
605311-1	Standard	3.07	706998-13X	707128X	708017	706058X	35091-29	35091-29
605311-2	Powr Lok	3.07	706998-13X	707130X	708019	707074X	35091-29	35091-29
1987-93 D-300 Wide Track - ABS								
605513-1	Standard	3.07	707250-1X	708016	708017	707252X	43811-6	43811-6
605513-2	Powr Lok	3.07	707250-1X	708018	708019	707254X	43811-6	43811-6
1988-90 1/2 Front Section Motor Home								
605386-1	Standard	4.10	706998-3X	706051X	706055X	706058X	35091-11	35091-12
1989 D-300 Wide Track - ABS								
605408-1	Standard	3.07	706998-13X	707128X	708017	706058X	35091-10	35091-10
605408-2	Powr Lok	3.07	706998-13X	707130X	708019	707074X	35091-10	35091-10
1989-90 D-300 & D-700 - ABS								
605373-1	Standard	4.56	706998-4X	707124X	708023	706058X	35091-4	35091-4
605373-2	Powr Lok	4.56	706998-4X	707126X	708025	707074X	35091-4	35091-4
605373-3	Standard	4.56	706998-4X	707124X	708023	706058X	35091-4	35091-4
605373-4	Standard	3.54	706998-1X	707128X	708017	706058X	35091-4	35091-4
605373-5	Standard	4.10	706998-3X	707128X	708017	706058X	35091-4	35091-4
605373-6	Powr Lok	4.56	706998-4X	707126X	708025	707074X	35091-4	35091-4
605373-7	Standard	4.10	706998-3X	707128X	708017	706058X	35091-4	35091-4
605373-8	Powr Lok	4.10	706998-3X	707130X	708019	707074X	35091-4	35091-4
605373-9	Standard	4.10	706998-3X	707128X	708017	706058X	35091-4	35091-4
605373-10	Powr Lok	4.10	706998-3X	707130X	708019	707074X	35091-4	35091-4
605373-11	Powr Lok	3.54	706998-1X	707130X	708019	707074X	35091-4	35091-4

(7) See Ring Gear & Pinion Kits in XGI Catalog for ratio & tooth combinations.

(8) See Differential Case Assy Kits in XGI Catalog for spline data & ratios.

Dodge Model 70 /267 Rear Axles

Bill of Material Table

Axle			Axle Kits				Shaft & Joint Assy.	
Bill of Material	Diff. Type	Ratio	Ring Gear & Pinion Kit ⁽⁷⁾	Differential			Right Hand Shaft Assy.	Left Hand Shaft Assy.
				Case Assy. Kit ⁽⁸⁾	Case Kit	Inner Parts Kit		
1989-90 D-300								
605407-1	Standard	3.54	706998-1X	707128X	708017	706058X	35091-10	35091-10
605407-2	Standard	4.10	706998-3X	707128X	708017	706058X	35091-10	35091-10
605407-3	Standard	4.56	706998-4X	707124X	708023	706058X	35091-10	35091-10
605407-4	Standard	4.56	706998-4X	707124X	708023	706058X	35091-10	35091-10
605407-5	Powr Lok	4.56	706998-4X	707126X	708025	707074X	35091-10	35091-10
605407-6	Powr Lok	4.56	706998-4X	707126X	708025	707074X	35091-10	35091-10
605407-7	Standard	4.10	706998-3X	707128X	708017	706058X	35091-10	35091-10
605407-8	Powr Lok	4.10	706998-3X	707130X	708019	707074X	35091-10	35091-10
605407-9	Standard	4.10	706998-3X	707128X	708017	706058X	35091-10	35091-10
605407-10	Powr Lok	4.10	706998-3X	707130X	708019	707074X	35091-10	35091-10
605407-11	Standard	4.56	706998-4X	707124X	708023	706058X	35091-10	35091-10
605407-12	Powr Lok	7.17	706998-9X	707126X	708025	707074X	35091-10	35091-10
605407-13	Standard	7.17	706998-9X	707124X	708023	706058X	35091-10	35091-10
605407-14	No Spin	7.17	706998-9X	43911	-	-	35091-10	35091-10
1989-90 1/2 D-200 & D-300 & D-600 & D-700 - ABS								
605312-1	Standard	3.54	706998-1X	707128X	708017	706058X	35091-29	35091-29
605312-2	Powr Lok	3.54	706998-1X	707130X	708019	707074X	35091-29	35091-29
605312-3	Standard	4.10	706998-3X	707128X	708017	706058X	35091-29	35091-29
605312-4	Powr Lok	4.10	706998-3X	707130X	708019	707074X	35091-29	35091-29
605312-5	Standard	7.17	706998-14X	707124X	708023	706058X	35091-29	35091-29
1990 1/2 Air Force Tow Vehicle - ABS								
605489-1	Powr Lok	7.17	706998-14X	707126X	708025	707074X	35091-10	35091-10
605489-2	Standard	7.17	706998-14X	707124X	708023	706058X	35091-10	35091-10
605489-3	No Spin	7.17	706998-14X	43911	-	-	35091-10	35091-10
1991-93 1/2 Air Force Tow Vehicle - ABS								
605514-1	Powr Lok	7.17	708015-3	708024	708025	707254X	43811-6	43811-6
605514-2	Standard	7.17	708015-3	708022	708023	707252X	43811-6	43811-6
605514-3	No Spin	7.17	708015-3	44200	-	-	43811-6	43811-6
1991-93 1/2 D-200 & D-300 & D-600 & D-700 - ABS								
605508-1	Standard	3.07	707250-1X	708016	708017	707252X	43811-1	43811-1
605508-2	Powr Lok	3.07	707250-1X	708018	708019	707254X	43811-1	43811-1
605509-1	Standard	3.54	708015-1	708016	708017	707252X	43811-1	43811-1
605509-2	Standard	4.10	708015-2	708016	708017	707252X	43811-1	43811-1
605509-3	Powr Lok	4.10	708015-2	708018	708019	707254X	43811-1	43811-1
605509-4	Powr Lok	3.54	708015-1	708018	708019	707254X	43811-1	43811-1
605509-5	Standard	7.17	708015-3	708022	708023	707252X	43811-1	43811-1
605509-6	Powr Lok	3.54	708015-1	708018	708019	707254X	43811-1	43811-1
605509-7	Standard	3.54	708015-1	708016	708017	707252X	43811-1	43811-1
605509-8	Powr Lok	3.54	708015-1	708018	708019	707254X	43811-1	43811-1
605509-9	Standard	4.10	708015-2	708016	708017	707252X	43811-1	43811-1
605509-10	Powr Lok	4.10	708015-2	708018	708019	707253X	43811-1	43811-1
605509-11	Standard	4.56	707250-4X	708022	708023	707252X	43811-1	43811-1

(7) See Ring Gear & Pinion Kits in XGI Catalog for ratio & tooth combinations.

(8) See Differential Case Assy Kits in XGI Catalog for spline data & ratios.

Dodge Model 70 /267 Rear Axles

Bill of Material Table

Axle			Axle Kits				Shaft & Joint Assy.	
Bill of Material	Diff. Type	Ratio	Ring Gear & Pinion Kit ⁽⁷⁾	Differential			Right Hand Shaft Assy.	Left Hand Shaft Assy.
				Case Assy. Kit ⁽⁸⁾	Case Kit	Inner Parts Kit		
1991-93 1/2 D-300 Wide Track - ABS								
605512-1	Standard	3.54	708015-1	708016	708017	707252X	43811-6	43811-6
605512-2	Standard	4.10	708015-2	708016	708017	707252X	43811-6	43811-6
605512-3	Powr Lok	4.10	708015-2	708018	708019	707254X	43811-6	43811-6
605512-4	Standard	4.56	707250-4X	708022	708023	707252X	43811-6	43811-6
605512-5	Powr Lok	4.56	707250-4X	708024	708025	707254X	43811-6	43811-6
605512-6	Powr Lok	3.54	708015-1	708018	708019	707254X	43811-6	43811-6
605512-7	Powr Lok	4.56	707250-4X	708024	708025	707254X	43811-6	43811-6
605512-8	Powr Lok	3.54	708015-1	708018	708019	707254X	43811-6	43811-6
1991-93 1/2 D-300 & D-700 - ABS								
605510-1	Standard	3.07	707250-1X	708016	708017	707252X	43811-3	43811-3
605510-2	Powr Lok	3.07	707250-1X	708018	708019	707254X	43811-3	43811-3
605511-1	Standard	4.56	707250-4X	708022	708023	707252X	43811-3	43811-3
605511-2	Standard	3.54	708015-1	708016	708017	707252X	43811-3	43811-3
605511-3	Standard	4.10	708015-2	708016	708017	707252X	43811-3	43811-3
605511-4	Powr Lok	4.10	708015-2	708018	708019	707254X	43811-3	43811-3
605511-5	Powr Lok	4.56	707250-4X	708024	708025	707254X	43811-3	43811-3
605511-6	Powr Lok	3.54	708015-1	708018	708019	707254X	43811-3	43811-3
605511-7	Powr Lok	3.54	708015-1	708018	708019	707254X	43811-3	43811-3
1991-93 1/2 D-300 & D-400 & D-500 & D-600 & D-700 - ABS								
605522-1	Standard	3.54	708015-1	708016	708017	707252X	43811-1	43811-1
605522-2	Standard	4.10	708015-2	708016	708017	707252X	43811-1	43811-1
605522-3	Standard	4.56	707250-4X	708022	708023	707252X	43811-1	43811-1
605547-1	Standard	3.07	707250-1X	708016	708017	707252X	43811-1	43811-1

(7) See Ring Gear & Pinion Kits in XGI Catalog for ratio & tooth combinations.

(8) See Differential Case Assy Kits in XGI Catalog for spline data & ratios.

Dodge Model 70 /267 Rear Axles

Variable Parts Listing

Kits & Parts - Use With All Applications							
Description & Item Number (Refer to "Exploded View" at the front of this section)			Bills of Material				
			603651	603652	603653 603695 603696 603841	603916	603918
1	KIT – Inner Pinion Bearing	3	706060X	706060X	706060X	706060X	706060X
2	PKG – Diff & Pinion Bearing Shim	-	706213X	706077X	706213X	706213X	706213X
3	PKG – Pinion Bearing Shim	-	706357X	706357X	706357X	706357X	706357X
4	Baffle – Pinion Bearing	5	34849	34849	34849	34849	34849
5	Flat Spacer – Outer Pinion Bearing	6	—	46176	—	—	—
6	End Yoke Assembly (inc 11)	12	— ⁽⁹⁾	— ⁽⁹⁾	— ⁽⁹⁾	— ⁽⁹⁾	— ⁽⁹⁾
7	Washer – Pinion Nut	13	30275	30275	30275	30275	30275
8	KIT – Carrier Cover	-	706689X	706689X	706689X	706689X	706689X
9	Carrier Cover	15	33865	33865	33865	33865	33865
10	KIT – Differential Bearing	21	706047X	706070X	706047X	706070X	706047X
11	PKG – Diff Bearing Shim (inc 18)	22	708012	708012	708012	708012	708012
12	Bolt – Drive Gear (qty 12)	24	30266	30266	30266	30266	30266
13	Gear – Differential (std)	26	35079	35079	35079	35079	35079
14	Gear – Differential (p/l)	46	35294	35294	35294	35294	35294
			603955	603995 603997	603998	605158	605192
1	KIT – Inner Pinion Bearing	3	706060X	706060X	706060X	706861X	706861X
2	PKG – Diff & Pinion Bearing Shim	-	706213X	706213X	706077X	706863X	706863X
3	PKG – Pinion Bearing Shim	-	706357X	706357X	706357X	706862X	706862X
4	Baffle – Pinion Bearing Bearing	5	34849	34849	34849	—	—
5	Flat Spacer – Outer Pinion	6	—	—	—	46176	46176
6	End Yoke Assembly (inc 11)	12	— ⁽⁹⁾	— ⁽⁹⁾	— ⁽⁹⁾	— ⁽⁹⁾	2-4-8391-1X
7	Washer – Pinion Nut	13	30275	30275	30275	30275	30275
8	KIT – Carrier Cover	-	706689X	706689X	706689X	707181X	706980X
9	Carrier Cover	15	33865	33865	33865	42815-2	38454
10	KIT – Differential Bearing	21	706047X	706047X	706070X	706047X	706047X
11	PKG – Diff Bearing Shim (inc 18)	22	708012	708012	706373X	708012	708012
12	Bolt – Drive Gear (qty 12)	24	40638	30266	30266	40638	30266
13	Gear – Differential (std)	26	35079	35079	35079	35079	35079
14	Gear – Differential (p/l)	46	35294	35294	35294	35294	35294
			605214 605215	605235	605269 605270	605311 605312 605313	605373
1	KIT – Inner Pinion Bearing	3	706861X	706861X	706861X	706861X	706861X
2	PKG – Diff & Pinion Bearing Shim	-	706863X	706863X	706863X	706863X	706863X
3	PKG – Pinion Bearing Shim	-	706862X	706862X	706862X	706862X	706862X
4	Baffle – Pinion Bearing	5	—	—	—	—	—
5	Flat Spacer – Outer Pinion Bearing	6	46176	46176	46176	46176	46176
6	End Yoke Assembly (inc 11)	12	— ⁽⁹⁾	3-4-5711-1X	— ⁽⁹⁾	3-4-5711-1X	— ⁽⁹⁾
7	Washer – Pinion Nut	13	30275	30275	30275	30275	30275
8	KIT – Carrier Cover	-	706689X	707181X	706689X	707181X	707181X
9	Carrier Cover	15	33865	42815-2	33865	42815-2	42815-2
10	KIT – Differential Bearing	21	706047X	706047X	706047X	706047X	706047X
11	PKG – Diff Bearing Shim (inc 18)	22	708012	708012	708012	708012	708012
12	Bolt – Drive Gear (qty 12)	24	30266	40638	30266	40638	40638
13	Gear – Differential (std)	26	35079	35079	35079	35079	35079
14	Gear – Differential (p/l)	46	35294	35294	35294	35294	35294

(See next page for additional bills of material)

(9) Must identify yoke series used in vehicle; Service 7260 Series with 1310 Series using 2-4-8391X, 5-353X and 2-70-18X. Service 7290 Series with 2-4-7681-1X. Service 1410 Series with 3-4-5711-1X. Contact vehicle manufacturer for 5380 Series.

Dodge Model 70 /267 Rear Axles Variable Parts Listing

Kits & Parts - Use With All Applications							
Description & Item Number (Refer to "Exploded View" at the front of this section)			Bills of Material				
			605386	605407	605408	605489	605508 605509 605510 605511 605512
1	KIT – Inner Pinion Bearing	3	706861X	706861X	706861X	706861X	706861X
2	PKG – Diff & Pinion Bearing Shim	-	706863X	706863X	706863X	706863X	707258X
3	PKG – Pinion Bearing Shim	-	706862X	706862X	706862X	706862X	707257X
4	Baffle – Pinion Bearing	5	—	—	—	—	—
5	Flat Spacer – Outer Pinion Bearing	6	46176	46176	46176	46176	46176
6	End Yoke Assembly (inc 11)	12	3-4-5711-1X	— ⁽⁹⁾	3-4-5711-1X	3-4-5711-1X	3-4-11891-1X
7	Washer – Pinion Nut	13	30275	30275	30275	30275	44167
8	KIT – Carrier Cover	-	707181X	707181X	707181X	707181X	707181X
9	Carrier Cover	15	42815-2	42815-2	42815-2	42815-2	42815-2
10	KIT – Differential Bearing	21	706047X	706047X	706047X	706047X	706047X
11	PKG – Diff Bearing Shim (inc 18)	22	708012	708012	708012	708012	708012
12	Bolt – Drive Gear (qty 12)	24	40638	40638	40638	40638	40638
13	Gear – Differential (std)	26	35079	35079	35079	35079	43913
14	Gear – Differential (p/l)	46	35294	35294	35294	35294	43914
			605513	605514	605522 605547		
1	KIT – Inner Pinion Bearing	3	706861X	706861X	706861X		
2	PKG – Diff & Pinion Bearing Shim	-	707258X	707258X	707258X		
3	PKG – Pinion Bearing Shim	-	707257X	707257X	707257X		
4	Baffle – Pinion Bearing	5	—	—	—		
5	Flat Spacer – Outer Pinion Bearing	6	46176	46176	46176		
6	End Yoke Assembly (inc 11)	12	3-4-11891-1X	3-4-11891-1X	3-4-11891-1X		
7	Washer – Pinion Nut	13	44167	44167	44167		
8	KIT – Carrier Cover	-	707181X	707181X	707181X		
9	Carrier Cover	15	42815-2	42815-2	42815-2		
10	KIT – Differential Bearing	21	706047X	706047X	706047X		
11	PKG – Diff Bearing Shim (inc 18)	22	708012	708012	708012		
12	Bolt – Drive Gear (qty 12)	24	40638	40638	40638		
13	Gear – Differential (std)	26	35079	43913	43913		
14	Gear – Differential (p/l)	46	35294	43914	—		

(9) Must identify yoke series used in vehicle; Service 7260 Series with 1310 Series using 2-4-8391X, 5-353X and 2-70-18X. Service 7290 Series with 2-4-7681-1X. Service 1410 Series with 3-4-5711-1X. Contact vehicle manufacturer for 5380 Series.

Dodge / Chrysler 1994-1998

Model 70 /267 Rear Axles for

**D2500 & W3500 Ram
Air Force Tow Vehicle**

Dodge Model 70 /267 Rear Axles-Ram Exploded View

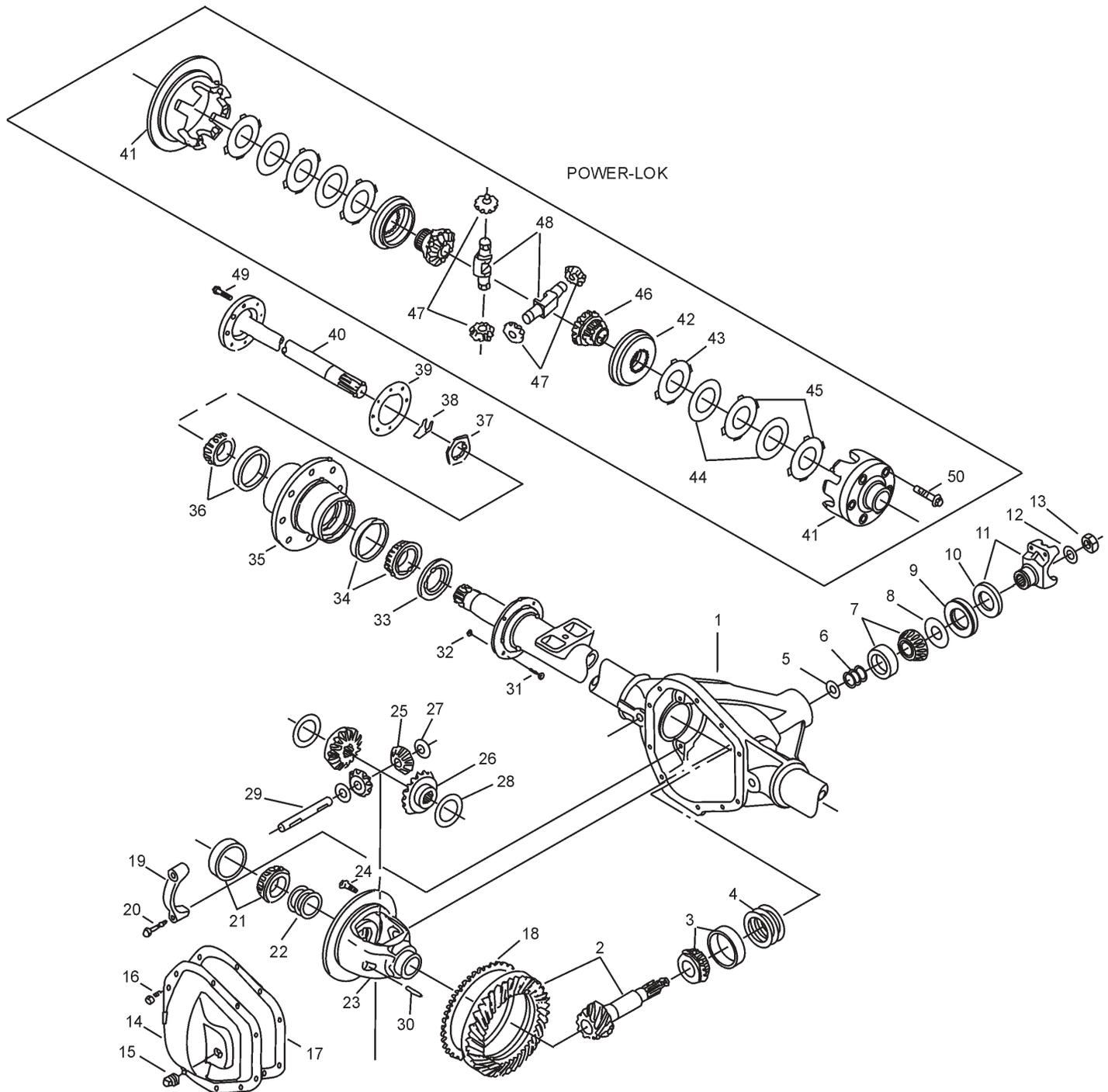

Dodge Model 70 /267 Rear Axles-Ram

Parts Listing

ITEM NO.	PART NUMBER	DESCRIPTION	ITEM NO.	PART NUMBER	DESCRIPTION
1	— ⁽³⁾	Housing – Axle Service	23	— ⁽¹⁾	Case – Differential (std)
2	— ⁽¹⁾	Drive Pinion & Gear Assembly	24	40638	Bolt – Drive Gear (qty 12)
3	706861X	KIT – Inner Pinion Bearing	25	35080	Pinion – Differential (std)
	708020	PKG – Diff & Pinion Bearing Shim (Inc items 4,6,13,17,22)	26	43913	Gear – Differential (std)
	707257X	PKG – Pinion Bearing Shim (inc items 4,6,13)	27	35082	Thrustwasher – Diff Pinion (std)
			28	34729	Thrustwasher – Diff Gear (std)
4	— ⁽⁴⁾	Inner Pinion Shims (see shim packages)	29	46640	Shaft – Differential (std)
5	46176	Flat Spacer – Outer Pinion	30	47024	Lock – Differential Shaft
6	— ⁽⁴⁾	Outer Pinion Shims (see shim packages)	31	— ⁽³⁾	Bolt – Brake Mounting
7	706045X	KIT – Outer Pinion Bearing	32	— ⁽³⁾	Nut – Brake Mounting
8	42737	Thrustwasher – Bearing	33	— ⁽²⁾	Seal – Hub
9	42449	Seal – Pinion Oil	34	— ⁽³⁾	KIT – Inner Wheel Bearing
10	34592	Slinger – End Yoke	35	— ⁽³⁾	Wheel Hub
11	3-4-11891-1X	End Yoke Assembly (inc 10)	36	— ⁽³⁾	KIT – Outer Wheel Bearing
12	44167	Washer – Pinion Nut	37	— ⁽²⁾	Spindle Nut
13	30271	Pinion Nut	38	46545	Locking Wedge
	— ⁽²⁾	KIT – Carrier Cover	39	39697	Gasket – Axle Shaft
14	— ⁽²⁾	Carrier Cover	40	43811-12	Shaft – Axle Flange Drive
15	43180	Plug – Carrier Cover	41	— ⁽¹⁾	Case – Differential (p/l)
16	34822	Bolt – Carrier Cover (qty 10)	42	42522	Ring – Differential Gear
17	34687	Gasket – Carrier Cover	43	707075X	KIT – Disc & Plate (p/l)
18	42929	Tone Ring (ABS)	44	— ⁽⁴⁾	Plate – Differential
19	— ⁽³⁾	Differential Bearing Cap	45	— ⁽⁴⁾	Disc – Differential Dished
20	48632-1	Bolt – Differential Bearing Cap	46	43914	Plate – Differential
21	706047X	KIT – Differential Bearing	47	31040	Gear – Differential (p/l)
22	708012	PKG – Diff Bearing Shim (inc 17)	48	31041	Pinion – Differential (p/l)
			49	— ⁽²⁾	Shaft – Differential (p/l)
			50	41610-1	Screw – Self Locking
					Flange Head Screw

- (1) See "Bill of Material Table" on next page
(2) See "Variable Parts Table" within this section
(3) Contact Vehicle Manufacturer
(4) Not Sold Separately

Dodge Model 70 /267 Rear Axles-Ram

Bill of Material Table

Axle			Axle Kits				Shaft & Joint Assy.	
Bill of Material	Diff. Type	Ratio	Ring Gear & Pinion Kit ⁽⁷⁾	Differential			Right Hand Shaft Assy.	Left Hand Shaft Assy.
				Case Assy. Kit ⁽⁸⁾	Case Kit	Inner Parts Kit		
1994-95 1/2 D2500								
605590-1	Standard	3.54	708015-1	708016	708017	707252X	43811-12	43811-12
605590-2	Standard	4.10	708015-2	708016	708017	707252X	43811-12	43811-12
605590-3	Powr Lok	4.10	708015-2	708018	708019	707254X	43811-12	43811-12
605590-4	Powr Lok	3.54	708015-1	708018	708019	707254X	43811-12	43811-12
605590-5	Standard	4.56	707250-4X	708022	708023	707252X	43811-12	43811-12
605590-6	Powr Lok	4.56	707250-4X	708024	708025	707254X	43811-12	43811-12
605590-7	Standard	3.54	708015-1	708016	708017	707252X	43811-12	43811-12
605590-8	Powr Lok	3.54	708015-1	708018	708019	707254X	43811-12	43811-12
605590-9	Standard	4.10	708015-2	708016	708017	707252X	43811-12	43811-12
605590-10	Powr Lok	4.10	708015-2	708018	708019	707254X	43811-12	43811-12
1994-95 1/2 W2500								
605588-1	Standard	3.54	708015-1	708016	708017	707252X	43811-12	43811-12
605588-2	Standard	4.10	708015-2	708016	708017	707252X	43811-12	43811-12
605588-3	Powr Lok	4.10	708015-2	708018	708019	707254X	43811-12	43811-12
605588-4	Powr Lok	3.54	708015-1	708018	708019	707254X	43811-12	43811-12
605588-5	Standard	4.56	707250-4X	708022	708023	707252X	43811-12	43811-12
605588-6	Powr Lok	4.56	707250-4X	708024	708025	707254X	43811-12	43811-12
605588-7	Standard	3.54	708015-1	708016	708017	707252X	43811-12	43811-12
605588-8	Standard	4.10	708015-2	708016	708017	707252X	43811-12	43811-12
605588-9	Powr Lok	4.10	708015-2	708018	708019	707254X	43811-12	43811-12
605588-10	Powr Lok	3.54	708015-1	708018	708019	707254X	43811-12	43811-12
1995-95 1/2 Air Force Tow Vehicle - ABS								
605722-1	Standard	7.17	708015-3	708022	708023	707252X	43811-12	43811-12
605722-2	Powr Lok	7.17	708015-3	708024	708025	707254X	43811-12	43811-12
605723-1	Standard	7.17	708015-3	708022	708023	707252X	43811-12	43811-12
605723-2	Powr Lok	7.17	708015-3	708024	708025	707254X	43811-12	43811-12
1996 W2500								
605900-1	Standard	3.54	708015-1	708016	708017	707252X	43811-12	43811-12
605900-2	Powr Lok	3.54	708015-1	708018	708019	707254X	43811-12	43811-12
605900-3	Standard	4.10	708015-2	708016	708017	707252X	43811-12	43811-12
605900-4	Powr Lok	4.10	708015-2	708018	708019	707254X	43811-12	43811-12
1996 W2500 - ABS								
605786-1	Standard	3.54	708015-1	708016	708017	707252X	43811-12	43811-12
605786-2	Standard	4.10	708015-2	708016	708017	707252X	43811-12	43811-12
605786-3	Powr Lok	4.10	708015-2	708018	708019	707254X	43811-12	43811-12
605786-4	Powr Lok	3.54	708015-1	708018	708019	707254X	43811-12	43811-12
1996-96 1/2 D2500								
605787-1	Standard	3.54	708015-1	708016	708017	707252X	43811-12	43811-12
605787-2	Powr Lok	3.54	708015-1	708018	708019	707254X	43811-12	43811-12
605787-3	Standard	4.10	708015-2	708016	708017	707252X	43811-12	43811-12
605787-4	Powr Lok	4.10	708015-2	708018	708019	707254X	43811-12	43811-12
1996-97 D2500								
605901-1	Standard	3.54	708015-1	708016	708017	707252X	43811-12	43811-12
605901-2	Powr Lok	3.54	708015-1	708018	708019	707254X	43811-12	43811-12
605901-3	Standard	4.10	708015-2	708016	708017	707252X	43811-12	43811-12
605901-4	Powr Lok	4.10	708015-2	708018	708019	707254X	43811-12	43811-12

(7) See Ring Gear & Pinion Kits in XGI Catalog for ratio & tooth combinations.

(8) See Differential Case Assy Kits in XGI Catalog for spline data & ratios.

Dodge Model 70 /267 Rear Axles-Ram

Bill of Material Table

Axle			Axle Kits				Shaft & Joint Assy.	
Bill of Material	Diff. Type	Ratio	Ring Gear & Pinion Kit ⁽⁷⁾	Differential			Right Hand Shaft Assy.	Left Hand Shaft Assy.
				Case Assy. Kit ⁽⁸⁾	Case Kit	Inner Parts Kit		
1996-97 1/2 Air Force Tow Vehicle - ABS								
605879-1	Standard	7.17	708015-3	708022	708023	707252X	43811-12	43811-12
605879-2	Powr Lok	7.17	708015-3	708024	708025	707254X	43811-12	43811-12
605880-1	Standard	7.17	708015-3	708022	708023	707252X	43811-12	43811-12
605880-2	Powr Lok	7.17	708015-3	708024	708025	707254X	43811-12	43811-12
1997 W2500								
606055-1	Standard	3.54	708015-1	708016	708017	707252X	43811-12	43811-12
606055-2	Powr Lok	3.54	708015-1	708018	708019	707254X	43811-12	43811-12
606055-3	Standard	4.10	708015-2	708016	708017	707252X	43811-12	43811-12
606055-4	Powr Lok	4.10	708015-2	708018	708019	707254X	43811-12	43811-12
1997-98 Air Force Tow Vehicle - ABS								
606013-1	Standard	7.17	708015-3	708022	708023	707252X	43811-12	43811-12
606013-2	Powr Lok	7.17	708015-3	708024	708025	707254X	43811-12	43811-12
606012-1	Standard	7.17	708015-3	708022	708023	707252X	43811-12	43811-12
606012-2	Powr Lok	7.17	708015-3	708024	708025	707254X	43811-12	43811-12
1998 D2500								
605981-1	Standard	3.54	708015-1	708016	708017	707252X	43811-12	43811-12
605981-2	Powr Lok	3.54	708015-1	708018	708019	707254X	43811-12	43811-12
605981-3	Standard	4.10	708015-2	708016	708017	707252X	43811-12	43811-12
605981-4	Powr Lok	4.10	708015-2	708018	708019	707254X	43811-12	43811-12
606094-1	Standard	3.54	708015-1	708016	708017	707252X	43811-12	43811-12
606094-2	Powr Lok	3.54	708015-1	708018	708019	707254X	43811-12	43811-12
606094-3	Standard	4.10	708015-2	708016	708017	707252X	43811-12	43811-12
606094-4	Powr Lok	4.10	708015-2	708018	708019	707254X	43811-12	43811-12
1998 W2500								
605980-1	Standard	3.54	708015-1	708016	708017	707252X	43811-12	43811-12
605980-2	Powr Lok	3.54	708015-1	708018	708019	707254X	43811-12	43811-12
605980-3	Standard	4.10	708015-2	708016	708017	707252X	43811-12	43811-12
605980-4	Powr Lok	4.10	708015-2	708018	708019	707254X	43811-12	43811-12
606063-1	Standard	3.54	708015-1	708016	708017	707252X	43811-12	43811-12
606063-2	Powr Lok	3.54	708015-1	708018	708019	707254X	43811-12	43811-12
606063-3	Standard	4.10	708015-2	708016	708017	707252X	43811-12	43811-12
606063-4	Powr Lok	4.10	708015-2	708018	708019	707254X	43811-12	43811-12
606095-1	Standard	3.54	708015-1	708016	708017	707252X	43811-12	43811-12
606095-2	Powr Lok	3.54	708015-1	708018	708019	707254X	43811-12	43811-12
606095-3	Standard	4.10	708015-2	708016	708017	707252X	43811-12	43811-12
606095-4	Powr Lok	4.10	708015-2	708018	708019	707254X	43811-12	43811-12

(7) See Ring Gear & Pinion Kits in XGI Catalog for ratio & tooth combinations.

(8) See Differential Case Assy Kits in XGI Catalog for spline data & ratios.

Dodge Model 70 /267 Rear Axles-Ram

Variable Parts Listing

Kits & Parts - Use With All Applications							
Description & Item Number (Refer to "Exploded View" at the front of this section)			Bills of Material				
			605588	605590	605722	605723	605786
1	KIT – Carrier Cover	-	707351X	707352X	707351X	707352X	707351X
2	Carrier Cover	14	46293-2	46293-1	46293-2	46293-1	46293-2
3	Seal – Hub	33	43146	43146	43146	43146	43146
4	Spindle Nut	37	39695	39695	47163	47163	47163
5	Screw – Self Locking	49	43124	43124	43124	43124	43124
			605787	605879	605880	605900	605901
1	KIT – Carrier Cover	-	707352X	707351X	707352X	707351X	707352X
2	Carrier Cover	14	46293-1	46293-2	46293-1	46293-2	46293-1
3	Seal – Hub	33	43146	47507	47507	43146	47507
4	Spindle Nut	37	47163	47163	47163	47163	47163
5	Screw – Self Locking	49	43124	43124	43124	45720	45720
			605980	605981	606012	606013	606055
1	KIT – Carrier Cover	-	707351X	707352X	707351X	707352X	707351X
2	Carrier Cover	14	46293-2	46293-1	46293-2	46293-1	46293-2
3	Seal – Hub	33	43146	47507	47507	47507	47507
4	Spindle Nut	37	47163	47163	47163	47163	47163
5	Screw – Self Locking	49	43124	45720	45720	45720	45720
			606063	606094	606095		
1	KIT – Carrier Cover	-	707351X	707352X	707351X		
2	Carrier Cover	14	46293-2	46293-1	46293-2		
3	Seal – Hub	33	47507	47507	47507		
4	Spindle Nut	37	47163	47163	47163		
5	Screw – Self Locking	49	45720	45720	45720		

Dodge / Chrysler 1994-1998 1/2

Model 80 /286 Rear Axles for

D2500, D3500

W2500

Sweptline Vehicle

Dodge Model 80 /286 Rear Axles Exploded View

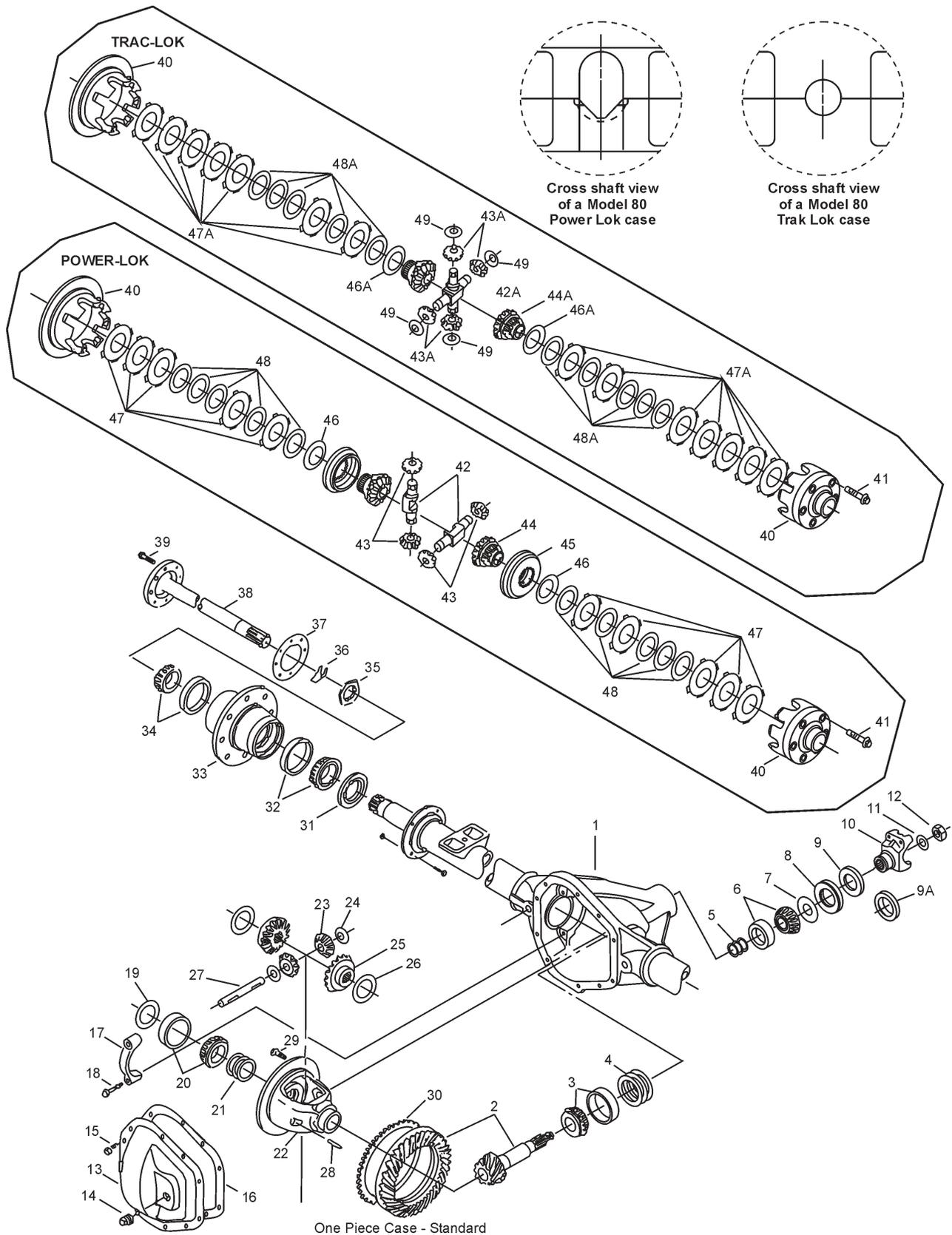

Dodge Model 80 /286 Rear Axles Parts Listing

ITEM NO.	PART NUMBER	DESCRIPTION	ITEM NO.	PART NUMBER	DESCRIPTION
1	— ⁽³⁾	Housing – Axle Service	26	34729	Thrustwasher – Differential Gear
2	— ⁽¹⁾	Drive Pinion & Gear Assembly	27	46640	Shaft – Differential
3	707065X	KIT – Inner Pinion Bearing	28	47024	Lock – Differential Shaft
	707066X	PKG – Pinion Bearing Shim (inc items 4, 5, 11, 12)	29	42433	Bolt – Drive Gear
	708036	PKG – Diff & Pinion Bearing Shim (inc items 4, 5, 11, 12, 21)	30	42414	Tone Ring (ABS)
4	— ⁽⁴⁾	Inner Pinion Shims (see shim packages)	31	— ⁽²⁾	Seal – Hub
5	— ⁽⁴⁾	Outer Pinion Shims (see shim packages)	32	— ⁽³⁾	KIT – Inner Wheel Bearing
6	707064X	KIT – Outer Pinion Bearing	33	— ⁽³⁾	Hub Assembly
7	42430	Thrustwasher – Bearing	34	— ⁽³⁾	KIT – Outer Wheel Bearing
8	— ⁽²⁾	Seal – Pinion Oil	35	— ⁽²⁾	Spindle Nut
9	231872	Seal – Deflector	36	46545	Locking Wedge
10	3-4-11081-1X	End Yoke Assembly (inc 9)	37	39697	Gasket
11	37104	Washer – Pinion Nut	38	— ⁽¹⁾	Shaft – Axle
12	37082	Pinion Nut	39	— ⁽²⁾	Flange Head Screw
	— ⁽²⁾	KIT – Carrier Cover (inc items 13, 14, 15)	40	— ⁽¹⁾	Case – Differential (p/l / t/l)
13	— ⁽²⁾	Carrier Cover	41	41610-1	Flange Head Screw
14	38637	Plug – Carrier Cover	42	070SS105	Shaft – Differential (p/l)
15	34822	Bolt – Carrier Cover	42A	47802	Shaft – Differential (t/l)
16	38615	RTV Silicone Sealant	43	31040	Pinion – Differential (p/l)
17	— ⁽³⁾	Differential Bearing Cap	43A	47798	Pinion – Differential (t/l)
18	48632-1	Bolt – Differential Bearing Cap	44	46394	Gear – Differential (p/l)
19	707069X	KIT – Outboard Bearing Spacer	44A	47796	Gear – Differential (t/l)
20	706070X	KIT – Differential Bearing	45	46395	Ring – Differential Gear (p/l)
21	708035	PKG – Differential Bearing Shim		701129X ⁽⁵⁾	KIT – Disc & Plate (p/l)
22	— ⁽¹⁾	Case – Differential (std)		702009 ⁽⁵⁾	KIT – Disc & Plate (t/l)
23	42413	Pinion – Differential (std)	46	— ⁽⁴⁾	Disc – Differential Dished (p/l)
24	35082	Thrustwasher – Differential Pinion	46A	— ⁽⁴⁾	Disc – Differential Dished (t/l)
25	42411	Gear – Differential (std)	47	— ⁽⁴⁾	Plate – Differential Pressure (p/l)
			47A	— ⁽⁴⁾	Plate – Differential Pressure (t/l)
			48	— ⁽⁴⁾	Disc – Differential Clutch (p/l)
			48A	— ⁽⁴⁾	Disc – Differential Clutch (t/l)
			49	—	Thrustwasher – Pinion Diff (t/l)

(1) See "Bill of Material Table" on next page

(2) See "Variable Parts Table" within this section

(3) Contact Vehicle Manufacturer

(4) Not Sold Separately

(5) Service Power Lok ratios 3.54 Case Assembly or Case Kit with 708054 Trak Lok
Service Power Lok ratios 4.10 Case Assembly or Case Kit with 708052 Trak Lok
The 708054 & 708052 Trak Lok uses 708051 Inner Parts Kit

Note: See cross shaft view illustration on previous page for the difference between a Power Lok and a Trak Lok case.

Dodge Model 80 /286 Rear Axles

Bill of Material Table

Axle			Axle Kits				Shaft & Joint Assy.	
Bill of Material	Diff. Type	Ratio	Ring Gear & Pinion Kit ⁽⁷⁾	Differential			Right Hand Shaft Assy.	Left Hand Shaft Assy.
				Case Assy. Kit ⁽⁸⁾	Case Kit	Inner Parts Kit		
1994-95 1/2 D2500 w/ABS								
605595-1	Standard	3.54	708026-1	708027	708028	707063X	45553-1	45553-1
605595-2	Powr Lok	3.54	708026-1	708029 ⁽⁹⁾	708030 ⁽⁹⁾	707358X ⁽⁹⁾	45553-1	45553-1
605595-3	Standard	4.10	708026-2	708031	708032	707063X	45553-1	45553-1
605595-6	Standard	3.54	708026-1	708027	708028	707063X	45553-1	45553-1
605595-8	Standard	4.10	708026-2	708031	708032	707063X	45553-1	45553-1
605595-10	Powr Lok	3.54	708026-1	708029 ⁽⁹⁾	708030 ⁽⁹⁾	707358X ⁽⁹⁾	45553-1	45553-1
605595-11	Powr Lok	4.10	708026-2	708033 ⁽⁹⁾	708034 ⁽⁹⁾	707358X ⁽⁹⁾	45553-1	45553-1
1994-95 1/2 D3500 w/ABS								
605593-1	Standard	3.54	708026-1	708027	708028	707063X	45553-2	45553-2
605593-2	Powr Lok	3.54	708026-1	708029 ⁽⁹⁾	708030 ⁽⁹⁾	707063X	45553-2	45553-2
605593-3	Standard	4.10	708026-2	708031	708032	707063X	45553-2	45553-2
605593-8	Standard	4.10	708026-2	708031	708032	707063X	45553-2	45553-2
605593-9	Standard	3.54	708026-1	708027	708028	707063X	45553-2	45553-2
605593-12	Standard	4.10	708026-2	708031	708032	707063X	45553-2	45553-2
605593-13	Powr Lok	3.54	708026-1	708029 ⁽⁹⁾	708030 ⁽⁹⁾	707358X ⁽⁹⁾	45553-2	45553-2
605593-14	Powr Lok	4.10	708026-2	708033 ⁽⁹⁾	708034 ⁽⁹⁾	707358X ⁽⁹⁾	45553-2	45553-2
1994-95 1/2 D3500 & W3500 w/ABS								
605594-1	Standard	3.54	708026-1	708027	708028	707063X	45553-3	45553-3
605594-2	Powr Lok	3.54	708026-1	708029 ⁽⁹⁾	708030 ⁽⁹⁾	707358X ⁽⁹⁾	45553-3	45553-3
605594-3	Standard	4.10	708026-2	708031	708032	707063X	45553-3	45553-3
605594-7	Standard	3.54	708026-1	708027	708028	707063X	45553-3	45553-3
605594-9	Standard	4.10	708026-2	708031	708032	707063X	45553-3	45553-3
605594-11	Powr Lok	3.54	708026-1	708029 ⁽⁹⁾	708030 ⁽⁹⁾	707358X ⁽⁹⁾	45553-3	45553-3
605594-12	Powr Lok	4.10	708026-2	708033 ⁽⁹⁾	708034 ⁽⁹⁾	707358X ⁽⁹⁾	45553-3	45553-3
1994-95 1/2 W2500 w/ABS								
605596-1	Standard	3.54	708026-1	708027	708028	707063X	45553-1	45553-1
605596-2	Powr Lok	3.54	708026-1	708029 ⁽⁹⁾	708030 ⁽⁹⁾	707358X ⁽⁹⁾	45553-1	45553-1
605596-3	Standard	4.10	708026-2	708031	708032	707063X	45553-1	45553-1
605596-6	Standard	3.54	708026-1	708027	708028	707063X	45553-1	45553-1
605596-8	Standard	4.10	708026-2	708031	708032	707063X	45553-1	45553-1
605596-10	Powr Lok	3.54	708026-1	708029 ⁽⁹⁾	708030 ⁽⁹⁾	707358X ⁽⁹⁾	45553-1	45553-1
605596-11	Powr Lok	4.10	708026-2	708033 ⁽⁹⁾	708034 ⁽⁹⁾	707358X ⁽⁹⁾	45553-1	45553-1
1994-95 1/2 W3500 w/ABS								
605592-1	Standard	3.54	708026-1	708027	708028	707063X	45553-2	45553-2
605592-2	Powr Lok	3.54	708026-1	708029 ⁽⁹⁾	708030 ⁽⁹⁾	707358X ⁽⁹⁾	45553-2	45553-2
605592-3	Standard	4.10	708026-2	708031	708032	707063X	45553-2	45553-2
605592-8	Standard	4.10	708026-2	708031	708032	707063X	45553-2	45553-2
605592-9	Standard	3.54	708026-1	708027	708028	707063X	45553-2	45553-2
605592-12	Standard	4.10	708026-2	708031	708032	707063X	45553-2	45553-2
605592-13	Powr Lok	3.54	708026-1	708029 ⁽⁹⁾	708030 ⁽⁹⁾	707358X ⁽⁹⁾	45553-2	45553-2
605592-14	Powr Lok	4.10	708026-2	708033 ⁽⁹⁾	708034 ⁽⁹⁾	707358X ⁽⁹⁾	45553-2	45553-2
1995-97 Sweptline Vehicle								
605718-1	Standard	3.54	708026-1	708027	708028	707063X	45553-2	45553-2
605718-2	Powr Lok	3.54	708026-1	708029 ⁽⁹⁾	708030 ⁽⁹⁾	707358X ⁽⁹⁾	45553-2	45553-2
605718-3	Standard	4.10	708026-2	708031	708032	707063X	45553-2	45553-2
605718-4	Powr Lok	4.10	708026-2	708033 ⁽⁹⁾	708034 ⁽⁹⁾	707358X ⁽⁹⁾	45553-2	45553-2

(7) See Ring Gear & Pinion Kits in XGI Catalog for ratio & tooth combinations.

(8) See Differential Case Assy Kits in XGI Catalog for spline data & ratios.

(9) Service Power Lok ratios 3.54 Case Assembly or Case Kit with 708054 Trak Lok.

Service Power Lok ratios 4.10 Case Assembly or Case Kit with 708052 Trak Lok.

The 708054 & 708052 Trak Lok uses 708051 Inner Parts Kit.

Note: See cross shaft view illustration on previous page for the difference between a Power Lok and a Trak Lok case.

Dodge Model 80 /286 Rear Axles

Bill of Material Table

Axle			Axle Kits				Shaft & Joint Assy.	
Bill of Material	Diff. Type	Ratio	Ring Gear & Pinion Kit ⁽⁷⁾	Differential			Right Hand Shaft Assy.	Left Hand Shaft Assy.
				Case Assy. Kit ⁽⁸⁾	Case Kit	Inner Parts Kit		
1996-96 1/2 D2500								
605791-1	Standard	3.54	708026-1	708027	708028	707063X	45553-1	45553-1
605791-2	Standard	4.10	708026-2	708031	708032	707063X	45553-1	45553-1
605791-3	Powr Lok	3.54	708026-1	708029 ⁽⁹⁾	708030 ⁽⁹⁾	707358X ⁽⁹⁾	45553-1	45553-1
605791-4	Powr Lok	4.10	708026-2	708033 ⁽⁹⁾	708034 ⁽⁹⁾	707358X ⁽⁹⁾	45553-1	45553-1
1996-96 1/2 D3500 w/ABS								
605789-1	Standard	3.54	708026-1	708027	708028	707063X	45553-2	45553-2
605789-2	Standard	4.10	708026-2	708031	708032	707063X	45553-2	45553-2
605789-3	Powr Lok	3.54	708026-1	708029 ⁽⁹⁾	708030 ⁽⁹⁾	707358X ⁽⁹⁾	45553-2	45553-2
605789-4	Powr Lok	4.10	708026-2	708033 ⁽⁹⁾	708034 ⁽⁹⁾	707358X ⁽⁹⁾	45553-2	45553-2
605789-5	Standard	3.54	708026-1	708027	708028	707063X	45553-2	45553-2
605789-6	Standard	4.10	708026-2	708031	708032	707063X	45553-2	45553-2
605789-7	Powr Lok	3.54	708026-1	708029 ⁽⁹⁾	708030 ⁽⁹⁾	707358X ⁽⁹⁾	45553-2	45553-2
605789-8	Powr Lok	4.10	708026-2	708033 ⁽⁹⁾	708034 ⁽⁹⁾	707358X ⁽⁹⁾	45553-2	45553-2
1996-96 1/2 D3500 & W3500 w/ABS								
605790-1	Standard	3.54	708026-1	708027	708028	707063X	45553-3	45553-3
605790-2	Standard	4.10	708026-2	708031	708032	707063X	45553-3	45553-3
605790-3	Powr Lok	3.54	708026-1	708029 ⁽⁹⁾	708030 ⁽⁹⁾	707358X ⁽⁹⁾	45553-3	45553-3
605790-4	Powr Lok	4.10	708026-2	708033 ⁽⁹⁾	708034 ⁽⁹⁾	707358X ⁽⁹⁾	45553-3	45553-3
605790-5	Standard	3.54	708026-1	708027	708028	707063X	45553-3	45553-3
605790-6	Standard	4.10	708026-2	708031	708032	707063X	45553-3	45553-3
605790-7	Powr Lok	3.54	708026-1	708029 ⁽⁹⁾	708030 ⁽⁹⁾	707358X ⁽⁹⁾	35553-3	35553-3
605790-8	Powr Lok	4.10	708026-2	708033 ⁽⁹⁾	708034 ⁽⁹⁾	707358X ⁽⁹⁾	45553-3	45553-3
1996-96 1/2 W3500								
605788-1	Standard	3.54	708026-1	708027	708028	707063X	45553-2	45553-2
605788-2	Standard	4.10	708026-2	708031	708032	707063X	45553-2	45553-2
605788-3	Powr Lok	3.54	708026-1	708029 ⁽⁹⁾	708030 ⁽⁹⁾	707358X ⁽⁹⁾	45553-2	45553-2
605788-4	Powr Lok	4.10	708026-2	708033 ⁽⁹⁾	708034 ⁽⁹⁾	707358X ⁽⁹⁾	45553-2	45553-2
605788-5	Standard	3.54	708026-1	708027	708028	707063X	45553-2	45553-2
605788-6	Standard	4.10	708026-2	708031	708032	707063X	45553-2	45553-2
605788-7	Powr Lok	3.54	708026-1	708029 ⁽⁹⁾	708030 ⁽⁹⁾	707358X ⁽⁹⁾	45553-2	45553-2
605788-8	Powr Lok	4.10	708026-2	708033 ⁽⁹⁾	708034 ⁽⁹⁾	707358X ⁽⁹⁾	45553-2	45553-2
1996 1/2 D2500								
605792-1	Standard	3.54	708026-1	708027	708028	707063X	45553-1	45553-1
605792-2	Standard	4.10	708026-2	708031	708032	707063X	45553-1	45553-1
605792-3	Powr Lok	3.54	708026-1	708029 ⁽⁹⁾	708030 ⁽⁹⁾	707358X ⁽⁹⁾	45553-1	45553-1
605792-4	Powr Lok	4.10	708026-2	708033 ⁽⁹⁾	708034 ⁽⁹⁾	707358X ⁽⁹⁾	45553-1	45553-1
1997 D2500								
605905-1	Standard	3.54	708026-1	708027	708028	707063X	45553-1	45553-1
605905-2	Powr Lok	3.54	708026-1	708029 ⁽⁹⁾	708030 ⁽⁹⁾	707358X ⁽⁹⁾	45553-1	45553-1
605905-3	Standard	4.10	708026-2	708031	708032	707063X	45553-1	45553-1
605905-4	Powr Lok	4.10	708026-2	708033 ⁽⁹⁾	708034 ⁽⁹⁾	707358X ⁽⁹⁾	45553-1	45553-1
1997 W2500								
605906-1	Standard	3.54	708026-1	708027	708028	707063X	45553-1	45553-1
605906-2	Powr Lok	3.54	708026-1	708029 ⁽⁹⁾	708030 ⁽⁹⁾	707358X ⁽⁹⁾	45553-1	45553-1
605906-3	Standard	4.10	708026-2	708031	708032	707063X	45553-1	45553-1
605906-4	Powr Lok	4.10	708026-2	708033 ⁽⁹⁾	708034 ⁽⁹⁾	707358X ⁽⁹⁾	45553-1	45553-1

(7) See Ring Gear & Pinion Kits in XGI Catalog for ratio & tooth combinations.

(8) See Differential Case Assy Kits in XGI Catalog for spline data & ratios.

(9) Service Power Lok ratios 3.54 Case Assembly or Case Kit with 708054 Trak Lok.

Service Power Lok ratios 4.10 Case Assembly or Case Kit with 708052 Trak Lok.

The 708054 & 708052 Trak Lok uses 708051 Inner Parts Kit.

Note: See cross shaft view illustration on previous page for the difference between a Power Lok and a Trak Lok case.

Dodge Model 80 /286 Rear Axles

Bill of Material Table

Axle			Axle Kits				Shaft & Joint Assy.	
Bill of Material	Diff. Type	Ratio	Ring Gear & Pinion Kit ⁽⁷⁾	Differential			Right Hand Shaft Assy.	Left Hand Shaft Assy.
				Case Assy. Kit ⁽⁸⁾	Case Kit	Inner Parts Kit		
1997 D3500 w/ABS								
605903-1	Standard	3.54	708026-1	708027	708028	707063X	45553-2	45553-2
605903-2	Powr Lok	3.54	708026-1	708029 ⁽⁹⁾	708030 ⁽⁹⁾	707358X ⁽⁹⁾	45553-2	45553-2
605903-3	Standard	4.10	708026-2	708031	708032	707063X	45553-2	45553-2
605903-4	Powr Lok	4.10	708026-2	708033 ⁽⁹⁾	708034 ⁽⁹⁾	707358X ⁽⁹⁾	45553-2	45553-2
1997 D3500 & W3500 w/ABS								
605904-1	Standard	3.54	708026-1	708027	708028	707063X	45553-3	45553-3
605904-2	Powr Lok	3.54	708026-1	708029 ⁽⁹⁾	708030 ⁽⁹⁾	707358X ⁽⁹⁾	45553-3	45553-3
605904-3	Standard	4.10	708026-2	708031	708032	707063X	45553-3	45553-3
605904-4	Powr Lok	4.10	708026-2	708033 ⁽⁹⁾	708034 ⁽⁹⁾	707358X ⁽⁹⁾	45553-3	45553-3
1997 W3500								
605902-1	Standard	3.54	708026-1	708027	708028	707063X	45553-2	45553-2
605902-2	Powr Lok	3.54	708026-1	708029 ⁽⁹⁾	708030 ⁽⁹⁾	707358X ⁽⁹⁾	45553-2	45553-2
605902-3	Standard	4.10	708026-2	708031	708032	707063X	45553-2	45553-2
605902-4	Powr Lok	4.10	708026-2	708033 ⁽⁹⁾	708034 ⁽⁹⁾	707358X ⁽⁹⁾	45553-2	45553-2
1997 1/2 D3500 w/ABS								
605976-1	Standard	3.54	708026-1	708027	708028	707063X	45553-2	45553-2
605976-2	Powr Lok	3.54	708026-1	708029 ⁽⁹⁾	708030 ⁽⁹⁾	707358X ⁽⁹⁾	45553-2	45553-2
605976-3	Standard	4.10	708026-2	708031	708032	707063X	45553-2	45553-2
605976-4	Powr Lok	4.10	708026-2	708033 ⁽⁹⁾	708034 ⁽⁹⁾	707358X ⁽⁹⁾	45553-2	45553-2
1997 1/2 D3500 & W3500 w/ABS								
605977-1	Standard	3.54	708026-1	708027	708028	707063X	45553-3	45553-3
605977-2	Powr Lok	3.54	708026-1	708029 ⁽⁹⁾	708030 ⁽⁹⁾	707358X ⁽⁹⁾	45553-3	45553-3
605977-3	Standard	4.10	708026-2	708031	708032	707063X	45553-3	45553-3
605977-4	Powr Lok	4.10	708026-2	708033 ⁽⁹⁾	708034 ⁽⁹⁾	707358X ⁽⁹⁾	45553-3	45553-3
1997 1/2 W2500								
606056-1	Standard	3.54	708026-1	708027	708028	707063X	45553-1	45553-1
606056-2	Powr Lok	3.54	708026-1	708029 ⁽⁹⁾	708030 ⁽⁹⁾	707358X ⁽⁹⁾	45553-1	45553-1
606056-3	Standard	4.10	708026-2	708031	708032	707063X	45553-1	45553-1
606056-4	Powr Lok	4.10	708026-2	708033 ⁽⁹⁾	708034 ⁽⁹⁾	707358X ⁽⁹⁾	45553-1	45553-1
1997 1/2 W3500								
605975-1	Standard	3.54	708026-1	708027	708028	707063X	45553-2	45553-2
605975-2	Powr Lok	3.54	708026-1	708029 ⁽⁹⁾	708030 ⁽⁹⁾	707358X ⁽⁹⁾	45553-2	45553-2
605975-3	Standard	4.10	708026-2	708031	708032	707063X	45553-2	45553-2
605975-4	Powr Lok	4.10	708026-2	708033 ⁽⁹⁾	708034 ⁽⁹⁾	707358X ⁽⁹⁾	45553-2	45553-2
1998-98 1/2 D2500								
605985-1	Standard	3.54	708026-1	708027	708028	707063X	45553-1	45553-1
605985-2	Powr Lok	3.54	708026-1	708029 ⁽⁹⁾	708030 ⁽⁹⁾	707358X ⁽⁹⁾	45553-1	45553-1
605985-3	Standard	4.10	708026-2	708031	708032	707063X	45553-1	45553-1
605985-4	Powr Lok	4.10	708026-2	708033 ⁽⁹⁾	708034 ⁽⁹⁾	707358X ⁽⁹⁾	45553-1	45553-1
1998-98 1/2 W2500								
606064-1	Standard	3.54	708026-1	708027	708028	707063X	45553-1	45553-1
606064-2	Powr Lok	3.54	708026-1	708029 ⁽⁹⁾	708030 ⁽⁹⁾	707358X ⁽⁹⁾	45553-1	45553-1
606064-3	Standard	4.10	708026-2	708031	708032	707063X	45553-1	45553-1
606064-4	Powr Lok	4.10	708026-2	708033 ⁽⁹⁾	708034 ⁽⁹⁾	707358X ⁽⁹⁾	45553-1	45553-1

(7) See Ring Gear & Pinion Kits in XGI Catalog for ratio & tooth combinations.

(8) See Differential Case Assy Kits in XGI Catalog for spline data & ratios.

(9) Service Power Lok ratios 3.54 Case Assembly or Case Kit with 708054 Trak Lok.

Service Power Lok ratios 4.10 Case Assembly or Case Kit with 708052 Trak Lok.

The 708054 & 708052 Trak Lok uses 708051 Inner Parts Kit.

Note: See cross shaft view illustration on previous page for the difference between a Power Lok and a Trak Lok case.

Dodge Model 80 /286 Rear Axles Bill of Material Table

Axle			Axle Kits				Shaft & Joint Assy.	
Bill of Material	Diff. Type	Ratio	Ring Gear & Pinion Kit ⁽⁷⁾	Differential			Right Hand Shaft Assy.	Left Hand Shaft Assy.
				Case Assy. Kit ⁽⁸⁾	Case Kit	Inner Parts Kit		
1998-98 1/2 D3500 w/ABS								
605983-1	Standard	3.54	708026-1	708027	708028	707063X	45553-2	45553-2
605983-2	Powr Lok	3.54	708026-1	708029 ⁽⁹⁾	708030 ⁽⁹⁾	707358X ⁽⁹⁾	45553-2	45553-2
605983-3	Standard	4.10	708026-2	708031	708032	707063X	45553-2	45553-2
605983-4	Powr Lok	4.10	708026-2	708033 ⁽⁹⁾	708034 ⁽⁹⁾	707358X ⁽⁹⁾	45553-2	45553-2
1998-98 1/2 D3500 & W3500 w/ABS								
605984-1	Standard	3.54	708026-1	708027	708028	707063X	45553-3	45553-3
605984-2	Powr Lok	3.54	708026-1	708029 ⁽⁹⁾	708030 ⁽⁹⁾	707358X ⁽⁹⁾	45553-3	45553-3
605984-3	Standard	4.10	708026-2	708031	708032	707063X	45553-3	45553-3
605984-4	Powr Lok	4.10	708026-2	708033 ⁽⁹⁾	708034 ⁽⁹⁾	707358X ⁽⁹⁾	45553-3	45553-3
1998-98 1/2 W3500								
605982-1	Standard	3.54	708026-1	708027	708028	707063X	45553-2	45553-2
605982-2	Powr Lok	3.54	708026-1	708029 ⁽⁹⁾	708030 ⁽⁹⁾	707358X ⁽⁹⁾	45553-2	45553-2
605982-3	Standard	4.10	708026-2	708031	708032	707063X	45553-2	45553-2
605982-4	Powr Lok	4.10	708026-2	708033 ⁽⁹⁾	708034 ⁽⁹⁾	707358X ⁽⁹⁾	45553-2	45553-2

(7) See Ring Gear & Pinion Kits in XGI Catalog for ratio & tooth combinations.

(8) See Differential Case Assy Kits in XGI Catalog for spline data & ratios.

(9) Service Power Lok ratios 3.54 Case Assembly or Case Kit with 708054 Trak Lok.

Service Power Lok ratios 4.10 Case Assembly or Case Kit with 708052 Trak Lok.

The 708054 & 708052 Trak Lok uses 708051 Inner Parts Kit.

Note: See cross shaft view illustration on previous page for the difference between a Power Lok and a Trak Lok case.

Dodge Model 80 /286 Rear Axles Variable Parts Listing

Kits & Parts - Use With All Applications							
Description & Item Number (Refer to "Exploded View" at the front of this section)			Bills of Material				
			605592	605593 605594	605595	605596	605718
1	Seal – Pinion Oil	8	43504	43504	43504	43504	43504
2	KIT – Carrier Cover	-	707231X	707329X	707329X	707231X	707329X
3	Carrier Cover	13	42434	45559	45559	42434	45559
4	Seal – Hub	31	35256	35256	43146	43146	35256
5	Spindle Nut	35	39695	39695	39695	39695	47163
6	Flange Head Screw	39	43124	43124	43124	43124	43124
			605788	605789 605790	605791	605792	605902
1	Seal – Pinion Oil	8	43504	43504	43504	43504	43504
2	KIT – Carrier Cover	-	707231X	707329X	707229X	707231X	707231X
3	Carrier Cover	13	42434	45559	45559	42434	42434
4	Seal – Hub	31	35256	35256	43146	43146	35256
5	Spindle Nut	35	47163	47163	47163	47163	47163
6	Flange Head Screw	39	43124	43124	43124	43124	43124
			605903 605904	605905	605906	605975	605976 605977
1	Seal – Pinion Oil	8	43504	43504	43504	43504	43504
2	KIT – Carrier Cover	-	707329X	707329X	707231X	707231X	707329X
3	Carrier Cover	13	45559	45559	42434	42434	45559
4	Seal – Hub	31	35256	47507	43146	35256	35256
5	Spindle Nut	35	47163	47163	47163	47163	47163
6	Flange Head Screw	39	43124	45720	45720	45720	45720
			605982	605983 605984	605985	606056	606064
1	Seal – Pinion Oil	8	46411	46411	46411	43504	46411
2	KIT – Carrier Cover	-	707231X	707329X	707329X	707231X	707231X
3	Carrier Cover	13	42434	45559	45559	42434	42434
4	Seal – Hub	31	35256	35256	47507	47507	47507
5	Spindle Nut	35	47163	47163	47163	47163	47163
6	Flange Head Screw	39	45720	45720	45720	45720	45720

Ford 1983-1997

Model 28 /174 IFS Front Axles for

**Bronco II
Ranger**

Ford Model 28 /174 IFS Front Axles Exploded View

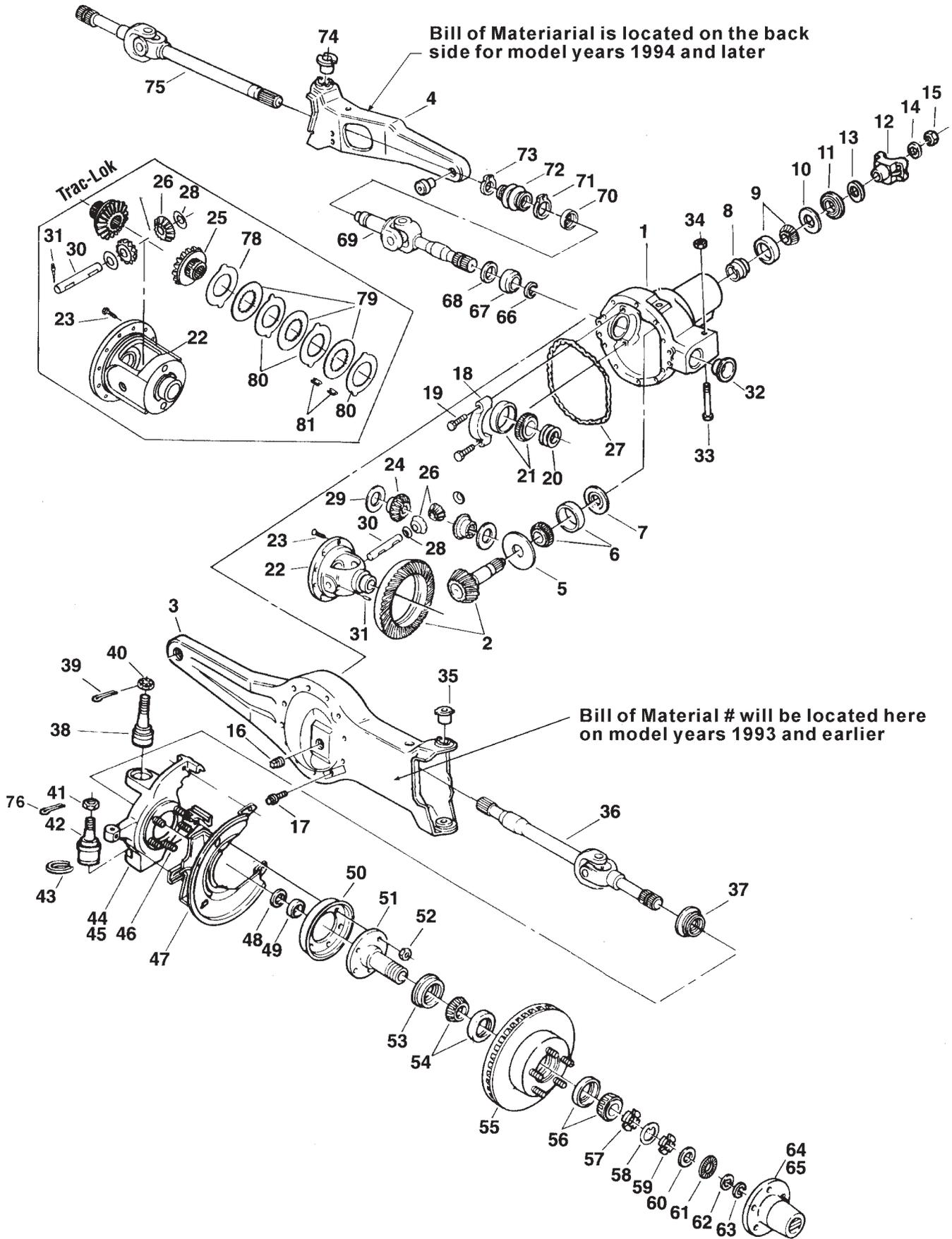

Ford Model 28 /174 IFS Front Axles

Parts Listing

ITEM NO.	PART NUMBER	DESCRIPTION	ITEM NO.	PART NUMBER	DESCRIPTION
1	— ⁽³⁾	Housing – Axle Service	38	— ⁽²⁾	Socket – Upper
2	— ⁽¹⁾	Drive Pinion & Gear Assembly	39	— ⁽²⁾	Cotter Pin (Upper Socket)
3	— ⁽³⁾	LH Support Arm Assembly		— ⁽²⁾	Snap Ring (Upper Socket)
4	— ⁽³⁾	RH Support Arm Assembly	40	— ⁽²⁾	Nut – Slotted Upper
5	— ⁽⁴⁾	Inner Pinion Shims	41	— ⁽²⁾	Lock Nut (Lower Socket)
		(see shim packages)	42	— ⁽²⁾	Socket – Lower
	707081X	KIT – Pinion Bearing Shim	43	40547	Snap Ring
		(inc items 5, 8, 14, 15, 27, 66)	44	— ⁽³⁾	Right Knuckle
	707082X	PKG – Diff & Pinion Bearing Shim	45	— ⁽³⁾	Left Knuckle
		(inc items 5, 8, 14, 15, 20, 27, 66)	46	— ⁽²⁾	Bolt – Hex
6	706123X	KIT – Inner Pinion Bearing	47	— ⁽³⁾	Splash Shield
7	620879	Baffle – Pinion Bearing	48	— ⁽²⁾	Oil Seal – Spindle
8	620878-1	Collapsible Spacer	49	— ⁽²⁾	Bearing Assembly – Spindle
9	706894X	KIT – Outer Pinion Bearing	50	— ⁽²⁾	Brake Dust Shield
10	36714	Slinger – Outer Pinion Bearing	51	— ⁽²⁾	Spindle
11	40554	Seal – Pinion Oil	52	40107	Lock Nut (qty 10)
12	2-4-6131-1X	End Yoke Assembly (inc 13)	53	— ⁽²⁾	Oil Seal
13	41498	Slinger – End Yoke	54	— ⁽²⁾	KIT – Inner Wheel Bearing
14	30186	Washer – Pinion Nut	55	— ⁽³⁾	Hub & Rotor
15	30185	Pinion Nut	56	— ⁽²⁾	KIT – Outer Wheel Bearing
16	— ⁽²⁾	Fill Plug	57	— ⁽²⁾	Nut & Pin Assy (manual hub lock)
17	40326-1	Bolt – Differential Carrier	58	— ⁽²⁾	Lock Nut (manual hub lock)
18	— ⁽⁴⁾	Differential Bearing Cap	59	— ⁽²⁾	Spindle Nut (manual hub lock)
19	620752	Bolt – Differential Bearing Cap	60	— ⁽²⁾	Thrustwasher - Bearing
20	706896X	PKG – Diff Bearing Shim (inc 27,66)	61	— ⁽²⁾	Bearing – Needle Thrust
21	706893X	KIT – Differential Bearing	62	— ⁽²⁾	Spacer – Axle Shaft
22	— ⁽⁴⁾	Case – Differential		— ⁽²⁾	PKG – Thrustwasher
23	41221	Bolt – Drive Gear (qty 10)	63	— ⁽²⁾	Snap Ring
24	40380	Gear – Differential (std)	64	— ⁽²⁾	Manual Hub Lock Assembly
25	40382	Gear – Differential (t/l)	65	— ⁽³⁾	Automatic Hub Lock Assembly
26	32926	Pinion – Differential	66	42570	Snap Ring
27	38615	RTV Silicone Sealant	67	565987	Bearing Assembly
28	34096	Thrustwasher – Differential Pinion	68	40108	Oil Seal
29	620875	Thrustwasher – Differential Gear (std)	69	— ⁽¹⁾	Shaft & Slip Yoke Assy (inc 70)
30	32915	Shaft – Differential	70	— ⁽²⁾	Oil Seal
31	13449	Lock – Differential Shaft	71	— ⁽²⁾	Clamp – Keystone
32	40403	Oil Seal	72	— ⁽²⁾	Rubber Boot
33	40817-1	Pinch Bolt	73	— ⁽²⁾	Clamp – Keystone
34	40818	Nut – Pinch Bolt	74	— ⁽⁵⁾	Camber Bushing (RH)
35	— ⁽⁵⁾	Camber Bushing (LH)	75	— ⁽¹⁾	Right Shaft & Joint Assembly
36	— ⁽¹⁾	Left Shaft & Joint Assembly	76	— ⁽²⁾	Cotter Pin (Lower Socket)
37	— ⁽²⁾	Oil Seal		706892X	KIT – Differential Plate & Disc (t/l)
	— ⁽²⁾	KIT – Spindle Assembly	78	— ⁽⁴⁾	Plate – Differential Pressure (t/l)
		(inc items 37, 48, 49, 51)	79	— ⁽⁴⁾	Disc – Differential (t/l)
	— ⁽²⁾	Spindle Assembly	80	— ⁽⁴⁾	Plate – Differential (t/l)
	— ⁽²⁾	KIT – Spindle Seal & Bearing			(selective thickness)
		(inc items 37, 48, 49)	81	35676	Differential Clutch Retainer (t/l)

(1) See "Bill of Material Table" on next page

(2) See "Variable Parts Table" within this section

(3) Contact Vehicle Manufacturer

(4) Not Sold Separately

(5) See Camber/Casting Bushing Table in the back of the Ford section of this catalog

Ford Model 28 /174 IFS Front Axles

Bill of Material Table

Axle			Axle Kits				Shaft & Joint Assy.		
Bill of Material	Diff. Type	Ratio	Ring Gear & Pinion Kit ⁽⁷⁾	Differential			Right Hand Shaft Assy.	Left Hand Shaft Assy.	Shaft & Slip Yoke Assy.
				Case Assy. Kit ⁽⁸⁾	Case Kit	Inner Parts Kit			
1983-84 Ranger									
610171-1	Standard	3.08	707080-1X	706972X	706973X	706890X	71702-1X	71703-1X	71691X
610171-3	Standard	3.45	707080-2X	706972X	706973X	706890X	71702-1X	71703-1X	71691X
610171-5	Standard	3.73	707080-3X	706974X	706975X	706890X	71702-1X	71703-1X	71691X
610171-6	Trac Lok	3.73	707080-3X	706885X	706889X	706891X	71702-1X	71703-1X	71691X
610171-8	Standard	3.45	707080-2X	706972X	706973X	706890X	71702-1X	71703-1X	71691X
610171-9	Standard	3.73	707080-3X	706974X	706975X	706890X	71702-1X	71703-1X	71691X
610171-10	Standard	4.10	707080-4X	706974X	706975X	706890X	71702-1X	71703-1X	71691X
610171-11	Standard	3.08	707080-1X	706972X	706973X	706890X	71702-1X	71703-1X	71691X
610171-12	Standard	3.45	707080-2X	706972X	706973X	706890X	71702-1X	71703-1X	71691X
610171-13	Standard	3.73	707080-3X	706974X	706975X	706890X	71702-1X	71703-1X	71691X
610171-14	Standard	3.45	707080-2X	706972X	706973X	706890X	71702-1X	71703-1X	71691X
610171-15	Standard	3.73	707080-3X	706974X	706975X	706890X	71702-1X	71703-1X	71691X
610171-16	Standard	4.10	707080-4X	706974X	706975X	706890X	71702-1X	71703-1X	71691X
610171-17	Trac Lok	4.10	707080-4X	706885X	706889X	706891X	71702-1X	71703-1X	71691X
1984 1/2-85 Ranger/Bronco II									
610223-1	Trac Lok	3.73	707080-3X	706885X	706889X	706891X	71702-1X	71703-1X	71691X
610223-2	Standard	3.08	707080-1X	706972X	706973X	706890X	71702-1X	71703-1X	71691X
610223-3	Standard	3.45	707080-2X	706972X	706973X	706890X	71702-1X	71703-1X	71691X
610223-4	Standard	3.73	707080-3X	706974X	706975X	706890X	71702-1X	71703-1X	71691X
610223-5	Standard	3.45	707080-2X	706972X	706973X	706890X	71702-1X	71703-1X	71691X
610223-6	Standard	3.73	707080-3X	706974X	706975X	706890X	71702-1X	71703-1X	71691X
610223-7	Standard	4.10	707080-4X	706974X	706975X	706890X	71702-1X	71703-1X	71691X
610223-8	Trac Lok	4.10	707080-4X	706885X	706889X	706891X	71702-1X	71703-1X	71691X
610223-9	Standard	3.45	707080-2X	706972X	706973X	706890X	71702-1X	71703-1X	71691X
610223-10	Standard	3.73	707080-3X	706974X	706975X	706890X	71702-1X	71703-1X	71691X
610223-11	Standard	4.10	707080-4X	706974X	706975X	706890X	71702-1X	71703-1X	71691X
1986-87 Ranger/Bronco II									
610249-1	Trac Lok	3.73	707080-3X	706885X	706889X	706891X	71702-1X	71703-1X	71691X
610249-2	Standard	3.08	707080-1X	706972X	706973X	706890X	71702-1X	71703-1X	71691X
610249-3	Standard	3.45	707080-2X	706972X	706973X	706890X	71702-1X	71703-1X	71691X
610249-4	Standard	3.73	707080-3X	706974X	706975X	706890X	71702-1X	71703-1X	71691X
610249-5	Standard	4.10	707080-4X	706974X	706975X	706890X	71702-1X	71703-1X	71691X
610249-6	Trac Lok	4.10	707080-4X	706885X	706889X	706891X	71702-1X	71703-1X	71691X
610249-7	Standard	3.45	707080-2X	706972X	706973X	706890X	71702-1X	71703-1X	71691X
610249-8	Standard	3.73	707080-3X	706974X	706975X	706890X	71702-1X	71703-1X	71691X
610249-9	Standard	4.10	707080-4X	706974X	706975X	706890X	71702-1X	71703-1X	71691X
1987 1/2 Ranger/Bronco II									
610298-3	Standard	3.45	707080-2X	706972X	706973X	706890X	71702-1X	71703-1X	71691X
610298-4	Standard	3.73	707080-3X	706974X	706975X	706890X	71702-1X	71703-1X	71691X
610298-5	Standard	4.10	707080-4X	706974X	706975X	706890X	71702-1X	71703-1X	71691X
610298-7	Standard	3.45	707080-2X	706972X	706973X	706890X	71702-1X	71703-1X	71691X
610298-8	Standard	3.73	707080-3X	706974X	706975X	706890X	71702-1X	71703-1X	71691X
610298-9	Standard	4.10	707080-4X	706974X	706975X	706890X	71702-1X	71703-1X	71691X

(7) See Ring Gear & Pinion Kits in XGI Catalog for ratio & tooth combinations.

(8) See Differential Case Assy Kits in XGI Catalog for spline data & ratios.

Ford Model 28 /174 IFS Front Axles Bill of Material Table

Axle			Axle Kits				Shaft & Joint Assy.		
Bill of Material	Diff. Type	Ratio	Ring Gear & Pinion Kit ⁽⁷⁾	Differential			Right Hand Shaft Assy.	Left Hand Shaft Assy.	Shaft & Slip Yoke Assy.
				Case Assy. Kit ⁽⁸⁾	Case Kit	Inner Parts Kit			
1988-89 Ranger/Bronco II									
610307-1	Standard	3.45	707080-2X	706972X	706973X	706890X	71702-1X	71703-1X	71691X
610307-2	Standard	3.73	707080-3X	706974X	706975X	706890X	71702-1X	71703-1X	71691X
610307-3	Standard	4.10	707080-4X	706974X	706975X	706890X	71702-1X	71703-1X	71691X
610307-4	Standard	3.45	707080-2X	706972X	706973X	706890X	71702-1X	71703-1X	71691X
610307-5	Standard	3.73	707080-3X	706974X	706975X	706890X	71702-1X	71703-1X	71691X
610307-6	Standard	4.10	707080-4X	706974X	706975X	706890X	71702-1X	71703-1X	71691X
1993-94 1/2 Ranger									
610418-1	Standard	3.73	707080-3X	707270X	707272X	706890X	74931-1X	74933-1X	74414-1X
610418-2	Standard	4.10	707080-4X	707270X	707272X	706890X	74931-1X	74933-1X	74414-1X
610418-3	Standard	3.73	707080-3X	707270X	707272X	706890X	74931-1X	74933-1X	74414-1X
610418-4	Standard	4.10	707080-4X	707270X	707272X	706890X	74931-1X	74933-1X	74414-1X
610418-5	Standard	3.45	707080-2X	707271X	707273X	706890X	74931-1X	74933-1X	74414-1X
610418-6	Standard	3.45	707080-2X	707271X	707273X	706890X	74931-1X	74933-1X	74414-1X
1995-97 1/2 Ranger - ABS									
610484-4	Standard	3.73	707080-3X	707270X	707272X	706890X	75240-1X	75242-1X	74414-1X
610484-6	Standard	4.10	707080-4X	707270X	707272X	706890X	75240-1X	75242-1X	74414-1X
610484-7	Standard	3.73	707080-3X	707270X	707272X	706890X	75240-1X	75242-1X	74414-1X
610484-8	Standard	4.10	707080-4X	707270X	707272X	706890X	75240-1X	75242-1X	74414-1X
1997 Ranger - non ABS									
610653-1	Standard	3.73	707080-3X	707270X	707272X	706890X	75240-1X	75242-1X	74414-1X
610653-2	Standard	3.73	707080-3X	707270X	707272X	706890X	75240-1X	75242-1X	74414-1X
610653-3	Standard	4.10	707080-4X	707270X	707272X	706890X	75240-1X	75242-1X	74414-1X
610653-4	Standard	4.10	707080-4X	707270X	707272X	706890X	75240-1X	75242-1X	74414-1X

(7) See Ring Gear & Pinion Kits in XGI Catalog for ratio & tooth combinations.

(8) See Differential Case Assy Kits in XGI Catalog for spline data & ratios.

Ford Model 28 /174 IFS Front Axles Variable Parts Listing

Kits & Parts - Use With All Applications							
Description & Item Number (Refer to "Exploded View" at the front of this section)			Bills of Material				
			610171	610223 610249 610298 610307	610418	610484	610653
1	Fill Plug	16	36472	36924-2	36472	36472	36472
2	Oil Seal	37	40684	40684	50492	50492	50492
3	KIT – Spindle Assembly	-	706901X	706901X	—	—	—
4	Spindle Assembly	-	71931X	71931X	74930X	75294X	74930X
5	KIT – Spindle Seal & Bearing	-	706902X	706902X	707316X	707355X	707355X
6	Socket – Upper	38	40379-1	40379-1	43200	43200	43200
7	Cotter Pin (Upper Socket)	39	500024-5	500024-5	—	—	—
8	Snap Ring (Upper Socket)	-	—	—	43671	43671	43671
9	Nut – Slotted Upper	40	40060	40060	—	—	—
10	Lock Nut (Lower Socket)	41	40061	40061	40060	40060	40060
11	Socket – Lower	42	40379-2	40379-2	43269	43269	43269
12	Bolt – Hex	46	40072-1	40072-1	42775	42775	42775
13	Oil Seal (Spindle)	48	40109	40109	45651	45651	45651
14	Bearing Assembly – Spindle	49	565984	565984	550579	550759	550759
15	Brake Dust Shield	50	42940	42940	—	46197	46197
16	Spindle	51	40404	40404	44824	44608	44824
17	Oil Seal	53	40400	40400	40709	76137X	76137X
18	KIT – Inner Wheel Bearing	54	706111X	706111X	706110X	706110X	706110X
19	KIT – Outer Wheel Bearing	56	706111X	706111X	706110X	706110X	706110X
20	Nut & Pin Assy (manual hub lock)	57	71526X	71526X	74078X	74078X	74078X
21	Lock Nut (manual hub lock)	58	40075	40075	36569	36569	36569
22	Spindle Nut (manual hub lock)	59	40080	40080	43749	43749	43749
23	Thrustwasher – Bearing	60	40724	40724	—	—	—
24	Bearing – Needle Thrust	61	565997	565997	—	—	—
25	Spacer – Axle Shaft	62	40067	40067	42773	—	—
26	PKG – Thrustwasher	-	—	—	—	701128X	701128X
27	Snap Ring	63	40079	40079	42768	42768	42768
28	Manual Hub Lock Assembly	64	40476	40476	42767	42767	42767
29	Oil Seal	70	40346	40346	40930	40930	40930
30	Clamp – Keystone	71	40540-1	40540-1	40540-4	40540-4	40540-4
31	Rubber Boot	72	40465	40465	40929	40929	40929
32	Clamp – Keystone	73	40540-2	40540-2	40540-3	40540-3	40540-3
33	Cotter Pin (Lower Socket)	76	—	—	44500	44500	44500

Ford 1990-1997 1/2

**Model 35 /194 IFS Front Axles
with Cardan Joints for**

**Bronco II
Explorer
Ranger**

Ford Model 35 /194 IFS Front Axles Exploded View

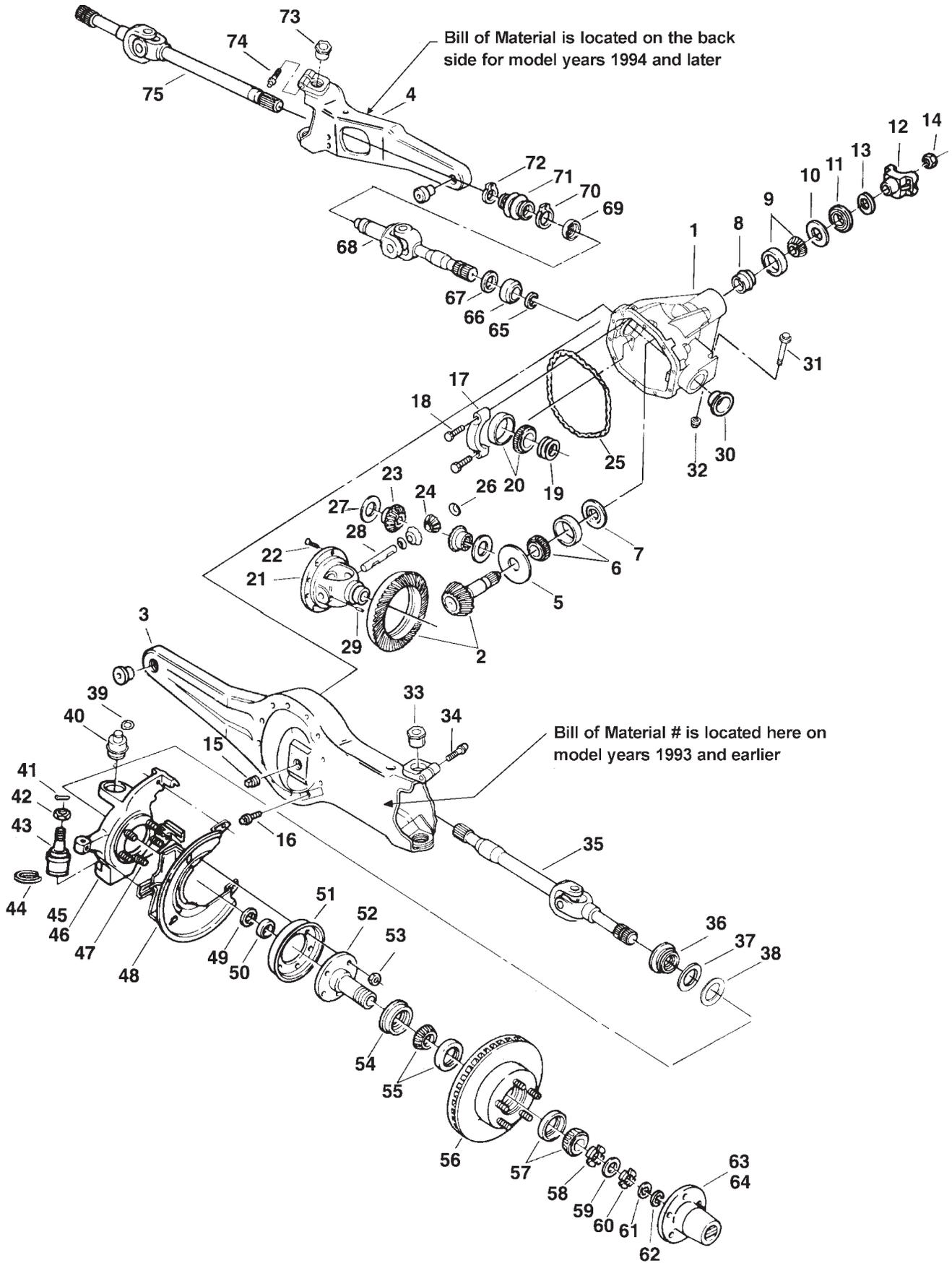

Ford Model 35 /194 IFS w/ Cardan Joints Front Axles

Parts Listing

ITEM NO.	PART NUMBER	DESCRIPTION	ITEM NO.	PART NUMBER	DESCRIPTION
1	— ⁽³⁾	Housing – Axle Service	41	— ⁽²⁾	Cotter Pin
2	— ⁽¹⁾	Drive Pinion & Gear Assembly	42	40060	Nut
3	— ⁽³⁾	LH Support Arm Assembly	43	43269	Socket – Lower
4	— ⁽³⁾	RH Support Arm Assembly	44	40547	Snap Ring
5	73952X	Slinger Shim – Inner Pinion Bearing	45	— ⁽³⁾	Right Knuckle
6	707162X	KIT – Inner Pinion Bearing	46	— ⁽³⁾	Left Knuckle
7	43599	Baffle – Pinion Bearing	47	42775	Bolt – Hex (qty 5)
8	42102	Collapsible Spacer	48	— ⁽³⁾	Splash Shield
9	706894X	KIT – Outer Pinion Bearing	49	— ⁽²⁾	Oil Seal – Spindle
10	42778	Slinger – Outer Pinion Bearing	50	550759	Bearing Assembly – Spindle
11	42103	Seal – Pinion Oil	51	— ⁽²⁾	Brake Dust Shield
12	2-4-6901-1X	End Yoke Assembly (inc 13)	52	— ⁽²⁾	Spindle
13	42779	Slinger – End Yoke	53	40107	Lock Nut (qty 10)
14	44189	Pinion Nut	54	— ⁽²⁾	Oil Seal
15	36472	Fill Plug	55	706110X	KIT – Inner Wheel Bearing
16	40326-1	Bolt – Differential Carrier	56	— ⁽³⁾	Hub & Rotor
17	— ⁽⁴⁾	Differential Bearing Cap	57	706110X	KIT – Outer Wheel Bearing
18	40284-1	Bolt – Differential Bearing Cap	58	74078X	Nut & Pin Assy (manual hub lock)
19	73139X	PKG – Differential Bearing Shim	59	36569	Lock Nut (manual hub lock)
20	706016X	KIT – Differential Bearing	60	43749	Spindle Nut (manual hub lock)
21	— ⁽⁴⁾	Case – Differential	61	— ⁽²⁾	Spacer – Axle Shaft
22	41221	Bolt – Drive Gear (qty 8)	— ⁽²⁾	— ⁽²⁾	PKG – Thrustwasher
23	— ⁽²⁾	Gear – Differential (std)	62	42768	Snap Ring
24	— ⁽²⁾	Pinion – Differential	63	42767	Manual Hub Lock Assembly
25	38615	RTV Silicone Sealant	64	— ⁽³⁾	Automatic Hub Lock Assembly
26	— ⁽²⁾	Thrustwasher – Differential Pinion	65	42570	Snap Ring
27	— ⁽²⁾	Thrustwasher – Differential Gear	66	565977	Bearing
28	— ⁽²⁾	Shaft – Differential	67	40773	Oil Seal
29	— ⁽²⁾	Roll Pin	68	— ⁽¹⁾	Shaft & Slip Yoke Assembly
30	40710	Oil Seal	69	40930	Oil Seal
31	40817-1	Pinch Bolt	70	40540-4	Clamp – Keystone
32	40818	Lock Nut	71	40929	Rubber Boot
33	— ⁽⁵⁾	Camber Bushing (LH)	72	40540-3	Clamp – Keystone
34	— ⁽²⁾	Pinch Bolt	73	— ⁽⁵⁾	Camber Bushing (RH)
35	— ⁽¹⁾	Left Shaft & Joint Assembly	74	— ⁽²⁾	Pinch Bolt
	— ⁽²⁾	KIT – Spindle Assembly	75	— ⁽¹⁾	Right Shaft & Joint Assembly
	— ⁽²⁾	KIT – Spindle Seal & Bearing	N.I.	— ⁽²⁾	Thrustwasher (automatic hub lock)
	— ⁽²⁾	Spindle Assembly	N.I.	— ⁽²⁾	Wheel Bearing Retainer (automatic hub lock)
36	— ⁽²⁾	Slinger			Bearing Adjusting Ring Lock (automatic hub lock)
37	— ⁽²⁾	Oil Seal	N.I.	— ⁽²⁾	Wheel Nut (automatic hub lock)
38	— ⁽²⁾	Spacer – Wheel Bearing Spindle			KIT – Sensor Housing (ABS)
39	43671	Snap Ring	N.I.	— ⁽²⁾	
40	43200	Socket – Upper		— ⁽³⁾	

N.I. = Not Illustrated

(1) See "Bill of Material Table" on next page

(2) See "Variable Parts Table" within this section

(3) Contact Vehicle Manufacturer

(4) Not Sold Separately

(5) See Camber/Casting Bushing Table in the back of the Ford section of this catalog

Ford Model 35 /194 IFS w/ Cardan Joints Front Axles X510-9

Bill of Material Table

Axle			Axle Kits				Shaft & Joint Assy.		
Bill of Material	Diff. Type	Ratio	Ring Gear & Pinion Kit ⁽⁷⁾	Differential			Right Hand Shaft Assy.	Left Hand Shaft Assy.	Shaft & Slip Yoke Assy.
				Case Assy. Kit ⁽⁸⁾	Case Kit	Inner Parts Kit			
1990 Ranger/Bronco II									
610300-1	Standard	3.73	707170-2X	707169X	707168X	707167X	73411-2X	73412-2X	73414-1X
610300-2	Standard	3.55	707170-1X	707169X	707168X	707167X	73411-2X	73412-2X	73414-1X
610300-3	Standard	3.73	707170-2X	707169X	707168X	707167X	73411-2X	73412-2X	73414-1X
610300-4	Standard	3.55	707170-1X	707169X	707168X	707167X	73411-2X	73412-2X	73414-1X
610300-5	Standard	4.10	707170-3X	707169X	707168X	707167X	73411-2X	73412-2X	73414-1X
610300-6	Standard	4.10	707170-3X	707169X	707168X	707167X	73411-2X	73412-2X	73414-1X
1990 1/2-92 1/2 Explorer									
610366-1	Standard	3.73	707170-2X	707169X	707168X	707167X	73411-2X	73412-2X	73414-1X
610366-2	Standard	3.55	707170-1X	707169X	707168X	707167X	73411-2X	73412-2X	73414-1X
610366-3	Standard	3.73	707170-2X	707169X	707168X	707167X	73411-2X	73412-2X	73414-1X
610366-4	Standard	3.55	707170-1X	707169X	707168X	707167X	73411-2X	73412-2X	73414-1X
610366-5	Standard	3.27	707170-4X	707169X	707168X	707167X	73411-2X	73412-2X	73414-1X
610366-6	Standard	3.27	707170-4X	707169X	707168X	707167X	73411-2X	73412-2X	73414-1X
610366-7	Standard	3.55	707170-1X	707169X	707168X	707167X	73411-2X	73412-2X	73414-1X
610366-8	Standard	3.73	707170-2X	707169X	707168X	707167X	73411-2X	73412-2X	73414-1X
1990 1/2-92 1/2 Ranger/Bronco II									
610365-1	Standard	3.73	707170-2X	707169X	707168X	707167X	73411-2X	73412-2X	73414-1X
610365-2	Standard	3.55	707170-1X	707169X	707168X	707167X	73411-2X	73412-2X	73414-1X
610365-3	Standard	3.73	707170-2X	707169X	707168X	707167X	73411-2X	73412-2X	73414-1X
610365-4	Standard	3.55	707170-1X	707169X	707168X	707167X	73411-2X	73412-2X	73414-1X
610365-5	Standard	4.10	707170-3X	707169X	707168X	707167X	73411-2X	73412-2X	73414-1X
610365-6	Standard	4.10	707170-3X	707169X	707168X	707167X	73411-2X	73412-2X	73414-1X
610365-7	Standard	3.27	707170-4X	707169X	707168X	707167X	73411-2X	73412-2X	73414-1X
610365-8	Standard	3.27	707170-4X	707169X	707168X	707167X	73411-2X	73412-2X	73414-1X
610365-9	Standard	3.55	707170-1X	707169X	707168X	707167X	73411-2X	73412-2X	73414-1X
610365-10	Standard	3.73	707170-2X	707169X	707168X	707167X	73411-2X	73412-2X	73414-1X
610365-11	Standard	4.10	707170-3X	707169X	707168X	707167X	73411-2X	73412-2X	73414-1X
1992 1/2 Explorer									
610437-1	Standard	3.27	707170-4X	707169X	707168X	707167X	73411-2X	73412-2X	73414-1X
610437-2	Standard	3.27	707170-4X	707169X	707168X	707167X	73411-2X	73412-2X	73414-1X
610437-3	Standard	3.55	707170-1X	707169X	707168X	707167X	73411-2X	73412-2X	73414-1X
610437-4	Standard	3.73	707170-2X	707169X	707168X	707167X	73411-2X	73412-2X	73414-1X
610437-5	Standard	3.73	707170-2X	707169X	707168X	707167X	73411-2X	73412-2X	73414-1X
1992 1/2 Ranger									
610436-1	Standard	3.27	707170-4X	707169X	707168X	707167X	73411-2X	73412-2X	73414-1X
610436-2	Standard	3.27	707170-4X	707169X	707168X	707167X	73411-2X	73412-2X	73414-1X
610436-3	Standard	3.55	707170-1X	707169X	707168X	707167X	73411-2X	73412-2X	73414-1X
610436-4	Standard	3.55	707170-1X	707169X	707168X	707167X	73411-2X	73412-2X	73414-1X
610436-5	Standard	3.73	707170-2X	707169X	707168X	707167X	73411-2X	73412-2X	73414-1X
610436-6	Standard	3.73	707170-2X	707169X	707168X	707167X	73411-2X	73412-2X	73414-1X
610436-7	Standard	4.10	707170-3X	707169X	707168X	707167X	73411-2X	73412-2X	73414-1X
610436-8	Standard	4.10	707170-3X	707169X	707168X	707167X	73411-2X	73412-2X	73414-1X

NOTE: All Ring & Pinion Kits with base number 707170 are reverse spiral bevel.

(7) See Ring Gear & Pinion Kits in XGI Catalog for ratio & tooth combinations.

(8) See Differential Case Assy Kits in XGI Catalog for spline data & ratios.

Ford Model 35 /194 IFS w/ Cardan Joints Front Axles

Bill of Material Table

Axle			Axle Kits				Shaft & Joint Assy.		
Bill of Material	Diff. Type	Ratio	Ring Gear & Pinion Kit ⁽⁷⁾	Differential			Right Hand Shaft Assy.	Left Hand Shaft Assy.	Shaft & Slip Yoke Assy.
				Case Assy. Kit ⁽⁸⁾	Case Kit	Inner Parts Kit			
1993-94 1/2 Explorer - ABS									
610410-1	Standard	3.73	707170-2X	707169X	707168X	707167X	74931-1X	74932-1X	73414-1X
610410-2	Standard	3.73	707170-2X	707169X	707168X	707167X	74931-1X	74932-1X	73414-1X
610410-3	Standard	3.27	707170-4X	707169X	707168X	707167X	74931-1X	74932-1X	73414-1X
610410-4	Standard	3.27	707170-4X	707169X	707168X	707167X	74931-1X	74932-1X	73414-1X
610410-5	Standard	3.55	707170-1X	707169X	707168X	707167X	74931-1X	74932-1X	73414-1X
1993-94 1/2 Ranger									
610419-1	Standard	3.73	707170-2X	707169X	707168X	707167X	74931-1X	74932-1X	73414-1X
610419-2	Standard	3.27	707170-4X	707169X	707168X	707167X	74931-1X	74932-1X	73414-1X
610419-3	Standard	3.27	707170-4X	707169X	707168X	707167X	74931-1X	74932-1X	73414-1X
610419-4	Standard	3.73	707170-2X	707169X	707168X	707167X	74931-1X	74932-1X	73414-1X
610419-5	Standard	3.45	73402-5X	707169X	707168X	707167X	74931-1X	74932-1X	73414-1X
610419-6	Standard	3.45	73402-5X	707169X	707168X	707167X	74931-1X	74932-1X	73414-1X
1995-97 1/2 Ranger - ABS									
610483-3	Standard	3.27	707170-4X	707169X	707168X	707167X	75240-1X	75241-1X	73414-1X
610483-4	Standard	3.27	707170-4X	707169X	707168X	707167X	75240-1X	75241-1X	73414-1X
610483-7	Standard	3.73	707170-2X	707169X	707168X	707167X	75240-1X	75241-1X	73414-1X
610483-8	Standard	3.73	707170-2X	707169X	707168X	707167X	75240-1X	75241-1X	73414-1X
610483-11	Standard	3.27	707170-4X	707169X	707168X	707167X	75240-1X	75241-1X	73414-1X
610483-12	Standard	3.73	707170-2X	707169X	707168X	707167X	75240-1X	75241-1X	73414-1X
1997-97 1/2 Ranger									
610652-1	Standard	3.27	707170-4X	707452X	707453X	707454X	75240-1X	75241-1X	73414-1X
610652-2	Standard	3.73	707170-2X	707452X	707453X	707454X	75240-1X	75241-1X	73414-1X
610652-3	Standard	3.27	707170-4X	707452X	707453X	707454X	75240-1X	75241-1X	73414-1X
610652-4	Standard	3.73	707170-2X	707452X	707453X	707454X	75240-1X	75241-1X	73414-1X

NOTE: All Ring & Pinion Kits with base number 707170 are reverse spiral bevel.

(7) See Ring Gear & Pinion Kits in XGI Catalog for ratio & tooth combinations.

(8) See Differential Case Assy Kits in XGI Catalog for spline data & ratios.

Ford Model 35 /194 IFS w/ Cardan Joints Front Axles

Variable Parts Listing

Kits & Parts - Use With All Applications							
Description & Item Number (Refer to "Exploded View" at the front of this section)			Bills of Material				
			610300	610365 610366	610410	610419	610436 610437
1	Gear – Differential (std)	23	42772	42772	42772	42772	42772
2	Pinion – Differential	24	43288	43288	43288	43288	43288
3	Thrustwasher – Differential Pinion	26	42077	42077	42077	42077	42077
4	Thrustwasher – Differential Gear	27	42078	42078	42078	42078	42078
5	Shaft – Differential	28	43220	43220	43220	43220	43220
6	Roll Pin	29	43245	43245	43245	43245	43245
7	Pinch Bolt	34	43672	43672	46286	46286	43672
8	KIT – Spindle Assembly	-	707166X	707166X	707341X	—	707166X
9	KIT – Spindle Seal & Bearing	-	706971X	706971X	707316X	707316X	706971X
10	Spindle Assembly	-	73608X	73608X	75294X	74930X	73608X
11	Slinger	36	36364	36364	—	—	36364
12	Oil Seal	37	38128	38128	50492	50492	38128
13	Spacer – Wheel Bearing Spindle	38	38106	38106	—	—	38106
14	Cotter Pin	41	500024-7	44500	44500	44500	44500
15	Oil Seal – Spindle	49	36361	36361	45651	45651	36361
16	Brake Dust Shield	51	42940	42940	—	—	42940
17	Spindle	52	43201	43201	44608	44824	43201
18	Oil Seal	54	40709	40709	40709	40709	40709
19	Spacer – Axle Shaft	61	42773	42773	42773	42773	42773
20	PKG – Thrustwasher	-	—	—	—	—	—
21	Pinch Bolt	74	43672	43672	46286	46286	43672
22	Thrustwasher (automatic hub lock)	N.I.	43978	43978	43978	43978	43978
23	Wheel Bearing Retainer (auto hub)	N.I.	42848	42848	42848	42848	42848
24	Bearing Adjusting Ring Lock	N.I.	42849	42849	42849	42849	42849
25	Wheel Nut (automatic hub lock)	N.I.	42850	42850	42850	42850	42850
			610483	610652			
1	Gear – Differential (std)	23	42772	46848			
2	Pinion – Differential	24	43288	32926			
3	Thrustwasher – Differential Pinion	26	42077	34096			
4	Thrustwasher – Differential Gear	27	42078	34095			
5	Shaft – Differential	28	43220	44690			
6	Roll Pin	29	43245	44811			
7	Pinch Bolt	34	46286	46286			
8	KIT – Spindle Assembly	-	—	—			
9	KIT – Spindle Seal & Bearing	-	707355X	707355X			
10	Spindle Assembly	-	75294X	74930X			
11	Slinger	36	—	—			
12	Oil Seal	37	50492	50492			
13	Spacer – Wheel Bearing Spindle	38	—	—			
14	Cotter Pin	41	44500	44500			
15	Oil Seal – Spindle	49	45651	45651			
16	Brake Dust Shield	51	46197	46197			
17	Spindle	52	44608	44824			
18	Oil Seal	54	76137X	76137X			
19	Spacer – Axle Shaft	61	—	—			
20	PKG – Thrustwasher	-	701128X	701128X			
21	Pinch Bolt	74	46286	46286			
22	Thrustwasher (automatic hub lock)	N.I.	—	—			
23	Wheel Bearing Retainer (auto hub)	N.I.	—	—			
24	Bearing Adjusting Ring Lock	N.I.	42849	—			
25	Wheel Nut (automatic hub lock)	N.I.	42850	—			

Ford 1980-1996 1/2

Model 44 /216 IFS Front Axles for

Bronco

Bronco II

F-150, F-250, F-350

Ranger

Ford Model 44 /216 IFS Front Axles Exploded View

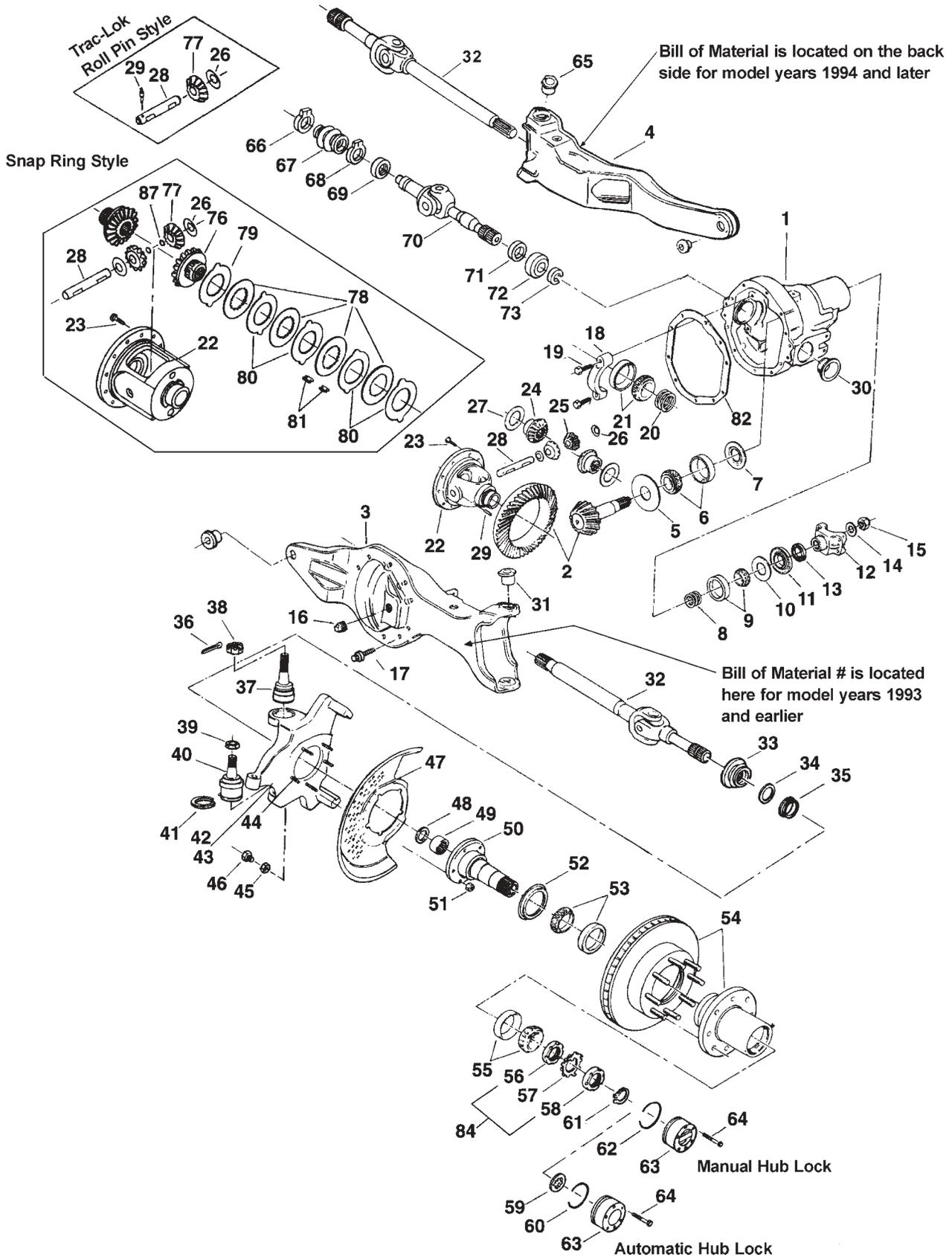

Ford Model 44 /216 IFS Front Axles

Parts Listing

ITEM NO.	PART NUMBER	DESCRIPTION	ITEM NO.	PART NUMBER	DESCRIPTION
1	— ⁽³⁾	Housing – Axle Service	45	— ⁽²⁾	Jam Nut
2	— ⁽¹⁾	Drive Pinion & Gear Assembly	46	— ⁽²⁾	Stop Screw
3	— ⁽³⁾	LH Support Arm Assembly	47	— ⁽³⁾	Dust Shield
4	— ⁽³⁾	RH Support Arm Assembly	48	— ⁽²⁾	Seal – Needle Bearing
5	— ⁽²⁾	Slinger Shim – Inner Pinion Bearing (see shim packages)	49	550759	Needle Bearing Assembly
	707238X	PKG – Pinion Bearing Shim (inc 5, 8, 14, 15, 73, 82)	50	— ⁽²⁾	Spindle
	707236X	PKG – Diff & Pinion Bearing Shim (inc 5, 8, 14, 15, 20, 73, 82)		— ⁽²⁾	KIT – Spindle Seal & Bearing (inc items 34, 35, 48, 49)
6	— ⁽²⁾	KIT – Inner Pinion Bearing	51	— ⁽²⁾	KIT – Spindle (33, 34, 35, 48, 49, 50)
7	— ⁽²⁾	Baffle – Pinion Bearing	52	— ⁽²⁾	Assembly – Spindle (inc 48, 49, 50)
8	— ⁽⁴⁾	Outer Pinion Bearing Shims (see shim packages)	53	— ⁽²⁾	Lock Nut (qty 10)
9	706030X	KIT – Outer Pinion Bearing	54	— ⁽³⁾	Oil Seal
10	13575	Slinger – Outer Pinion Bearing	55	706111X	KIT – Inner Wheel Bearing
11	40793	Seal – Pinion Oil	56	— ⁽²⁾	Hub & Rotor
12	2-4-6111X	End Yoke Assembly (inc 13)	57	— ⁽²⁾	KIT – Outer Wheel Bearing
13	41498	Slinger – End Yoke	58	— ⁽²⁾	Nut & Pin Assembly
14	30186	Washer – Pinion Nut	59	— ⁽²⁾	Lock Nut
15	30185	Pinion Nut	60	— ⁽²⁾	Spindle Nut
16	36472	Oil Fill Plug	61	— ⁽²⁾	Axle Shaft Retainer
17	620631	Bolt – Carrier	62	— ⁽²⁾	Snap Ring
18	— ⁽⁴⁾	Differential Bearing Cap	63	— ⁽³⁾	Snap Ring
19	48632-1	Screw – Differential Bearing Cap	64	— ⁽²⁾	Snap Ring
20	706928X	KIT – Differential Bearing Shim	65	— ⁽⁵⁾	Hub Lock
21	706032X	KIT – Differential Bearing	66	— ⁽²⁾	Screw – Socket Head (Hub Lock)
22	— ⁽⁴⁾	Case – Differential	67	40540-4	Camber Bushing (RH)
23	41221	Bolt – Drive Gear	68	40929	Clamp – Keystone
24	— ⁽²⁾	Gear – Differential (std)	69	40540-3	Rubber Boot
25	17717	Pinion – Differential (std)	70	40930	Clamp – Keystone
26	13338-3	Thrustwasher – Diff Pinion (std & t/l)	71	— ⁽¹⁾	Oil Seal
27	— ⁽²⁾	Thrustwasher – Differential Gear (std)	72	— ⁽²⁾	Shaft & Slip Yoke Assembly
28	39194	Shaft – Differential (std & t/l)	73	— ⁽²⁾	KIT – Unit Bearing & Seal (inc items 71, 72, 73)
29	13449 ⁽⁶⁾	Lock – Differential Shaft (std & t/l)		71	Oil Seal
30	40710	Oil Seal		72	Bearing
31	— ⁽⁵⁾	Camber Bushing (LH)		73	Snap Ring
32	— ⁽¹⁾	Shaft & Joint Assembly	N.I.	— ⁽²⁾	The following two parts were used in vehicles 1982 or earlier.
33	— ⁽²⁾	Slinger	N.I.	— ⁽²⁾	Retainer – Oil Seal
34	— ⁽²⁾	Oil Seal	76	—	Retainer – Bearing Ring
35	— ⁽²⁾	Spacer – Wheel Bearing Spindle	77	32808	Gear – Differential (t/l)
	700083-1X	KIT – Socket Assembly (36, 37, 38, 39, 40, 41 also includes 43579 camber bushing)		706352X	Pinion – Differential (t/l)
36	500024-8	Cotter Pin	78	— ⁽⁴⁾	KIT – Differential Plate & Disc (inc items 78, 79, 80, 81)
37	47184	Socket – Upper	79	— ⁽⁴⁾	Disc – Differential
38	44101	Nut – Upper	80	— ⁽⁴⁾	Plate – Differential
39	35566	Nut – Lower	81	40835	Plate – Differential Pressure
40	47182	Socket – Lower	82	34685	Clip – Differential Clutch Retainer
41	35928	Snap Ring	83	38615	Gasket
42	— ⁽³⁾	Right Knuckle	84	— ⁽²⁾	RTV Silicone Sealant
43	— ⁽³⁾	Left Knuckle	N.I.	— ⁽²⁾	Wheel Bearing Retainer Assembly
44	— ⁽²⁾	Bolt – Hex	86	— ⁽³⁾	PKG – Washer
			87	—	Sensor Housing Kit (ABS)
					Snap Ring Style Trac-Loc

N.I. = Not Illustrated

(1) See "Bill of Material Table" on next page

(2) See "Variable Parts Table" within this section

(3) Contact Vehicle Manufacturer

(4) Not Sold Separately

(5) See Camber/Casting Bushing Table in back of the Ford section of this catalog

(6) Some Trac Lok applications may have used two (2) part number 35660 snap rings instead of one (1) part number 13449 differential shaft lock

Ford Model 44 /216 IFS Front Axles

Bill of Material Table

Axle			Axle Kits				Shaft & Joint Assy.		
Bill of Material	Diff. Type	Ratio	Ring Gear & Pinion Kit ⁽⁷⁾	Differential			Right Hand Shaft Assy.	Left Hand Shaft Assy.	Shaft & Slip Yoke Assy.
				Case Assy. Kit ⁽⁸⁾	Case Kit	Inner Parts Kit			
1980 Bronco II & F-150 Pick-Up with Part Time Transfer Case									
610062-1	Standard	3.00	707240-2X	706020X	706024X	706027X	72044-1X	71394-1X	71432-1X
610062-2	Standard	3.00	707240-2X	706020X	706024X	706027X	72044-1X	71394-1X	71432-1X
610062-3	Standard	3.50	707240-5X	706020X	706024X	706027X	72044-1X	71394-1X	71432-1X
610062-4	Standard	3.50	707240-5X	706020X	706024X	706027X	72044-1X	71394-1X	71432-1X
610062-5	Trac Lok	3.50	707240-5X	707115X	707116X	706026X	72044-1X	71394-1X	71432-1X
610062-6	Trac Lok	3.50	707240-5X	707115X	707116X	706026X	72044-1X	71394-1X	71432-1X
610062-7	Standard	3.00	707240-2X	706020X	706024X	706027X	72044-1X	71394-1X	71432-1X
610062-8	Standard	3.00	707240-2X	706020X	706024X	706027X	72044-1X	71394-1X	71432-1X
610062-9	Standard	3.50	707240-5X	706020X	706024X	706027X	72044-1X	71394-1X	71432-1X
610062-10	Standard	3.50	707240-5X	706020X	706024X	706027X	72044-1X	71394-1X	71432-1X
610062-11	Trac Lok	3.50	707240-5X	707115X	707116X	706026X	72044-1X	71394-1X	71432-1X
610062-12	Trac Lok	3.50	707240-5X	707115X	707116X	706026X	72044-1X	71394-1X	71432-1X
610062-13	Standard	3.00	707240-2X	706020X	706024X	706027X	72044-1X	71394-1X	71432-1X
610062-14	Standard	3.00	707240-2X	706020X	706024X	706027X	72044-1X	71394-1X	71432-1X
610062-15	Standard	3.50	707240-5X	706020X	706024X	706027X	72044-1X	71394-1X	71432-1X
610062-16	Standard	3.50	707240-5X	706020X	706024X	706027X	72044-1X	71394-1X	71432-1X
610062-17	Trac Lok	3.50	707240-5X	707115X	707116X	706026X	72044-1X	71394-1X	71432-1X
610062-18	Trac Lok	3.50	707240-5X	707115X	707116X	706026X	72044-1X	71394-1X	71432-1X
610062-19	Standard	3.00	707240-2X	706020X	706024X	706027X	72044-1X	71394-1X	71432-1X
1980 F-250 3/4-Ton Pick-Up (Part Time Transfer Case)									
610063-1	Standard	3.54	707240-6X	706020X	706024X	706027X	71395-1X	71396-1X	660396-1
610063-2	Standard	3.54	707240-6X	706020X	706024X	706027X	71395-1X	71396-1X	660396-1
610063-3	Trac Lok	3.54	707240-6X	707115X	707116X	706026X	71395-1X	71396-1X	660396-1
610063-4	Trac Lok	3.54	707240-6X	707115X	707116X	706026X	71395-1X	71396-1X	660396-1
610063-5	Standard	4.09	707240-9X	706021X	706025X	706027X	71395-1X	71396-1X	660396-1
610063-6	Standard	3.54	707240-6X	706020X	706024X	706027X	71395-1X	71396-1X	660396-1
1981 F-250 & F-350 HD									
610146-1	Standard	3.00	707240-2X	706020X	706024X	706027X	72045-1X	71396-1X	660396-1
610146-2	Trac Lok	3.00	707240-2X	707115X	707116X	706026X	72045-1X	71396-1X	660396-1
610146-3	Standard	3.54	707240-6X	706020X	706024X	706027X	72045-1X	71396-1X	660396-1
610146-4	Trac Lok	3.54	707240-6X	707115X	707116X	706026X	72045-1X	71396-1X	660396-1
610146-5	Standard	3.00	707240-2X	706020X	706024X	706027X	72045-1X	71396-1X	660396-1
610146-6	Standard	3.54	707240-6X	706020X	706024X	706027X	72045-1X	71396-1X	660396-1
610146-7	Standard	3.54	707240-6X	706020X	706024X	706027X	72045-1X	71396-1X	660396-1
610146-8	Standard	4.09	707240-9X	706021X	706025X	706027X	72045-1X	71396-1X	660396-1
610146-9	Trac Lok	3.54	707240-6X	707115X	707116X	706026X	72045-1X	71396-1X	660396-1
1981-82 Bronco II & F-150									
610185-1	Standard	3.00	707240-2X	706020X	706024X	706027X	72044-1X	71394-1X	71432-1X
610185-2	Standard	3.00	707240-2X	706020X	706024X	706027X	72044-1X	71394-1X	71432-1X
610185-3	Standard	3.50	707240-5X	706020X	706024X	706027X	72044-1X	71394-1X	71432-1X
610185-4	Standard	3.50	707240-5X	706020X	706024X	706027X	72044-1X	71394-1X	71432-1X
610185-5	Trac Lok	3.50	707240-5X	707115X	707116X	706026X	72044-1X	71394-1X	71432-1X
610185-6	Trac Lok	3.50	707240-5X	707115X	707116X	706026X	72044-1X	71394-1X	71432-1X
610185-7	Standard	3.50	707240-5X	706020X	706024X	706027X	72044-1X	71394-1X	71432-1X
610185-8	Standard	3.00	707240-2X	706020X	706024X	706027X	72044-1X	71394-1X	71432-1X
610185-9	Standard	3.00	707240-2X	706020X	706024X	706027X	72044-1X	71394-1X	71432-1X
610185-10	Standard	3.50	707240-5X	706020X	706024X	706027X	72044-1X	71394-1X	71432-1X

Continued on next page

(7) See Ring Gear & Pinion Kits in XGI Catalog for ratio & tooth combinations.
 (8) See Differential Case Assy Kits in XGI Catalog for spline data & ratios.

Ford Model 44 /216 IFS Front Axles

Bill of Material Table

Axle			Axle Kits				Shaft & Joint Assy.		
Bill of Material	Diff. Type	Ratio	Ring Gear & Pinion Kit ⁽⁷⁾	Differential			Right Hand Shaft Assy.	Left Hand Shaft Assy.	Shaft & Slip Yoke Assy.
				Case Assy. Kit ⁽⁸⁾	Case Kit	Inner Parts Kit			
1981-82 Bronco II & F-150 (Continued)									
610185-11	Standard	3.50	707240-5X	706020X	706024X	706027X	72044-1X	71394-1X	71432-1X
610185-12	Trac Lok	3.50	707240-5X	707115X	707116X	706026X	72044-1X	71394-1X	71432-1X
610185-13	Standard	3.50	707240-5X	706020X	706024X	706027X	72044-1X	71394-1X	71432-1X
610185-14	Standard	3.07	707240-3X	706020X	706024X	706027X	72044-1X	71394-1X	71432-1X
610185-15	Standard	3.07	707240-3X	706020X	706024X	706027X	72044-1X	71394-1X	71432-1X
610185-16	Trac Lok	3.54	707240-6X	707115X	707116X	706026X	72044-1X	71394-1X	71432-1X
610185-17	Standard	3.54	707240-6X	706020X	706024X	706027X	72044-1X	71394-1X	71432-1X
610185-18	Standard	3.54	707240-6X	706020X	706024X	706027X	72044-1X	71394-1X	71432-1X
1981 1/2-82 F-150 Snow Plow									
610166-1	Standard	3.50	707240-5X	706020X	706024X	706027X	72044-1X	71394-1X	71432-1X
610166-2	Standard	3.50	707240-5X	706020X	706024X	706027X	72044-1X	71394-1X	71432-1X
610166-3	Trac Lok	3.00	707240-2X	707115X	707116X	706026X	72044-1X	71394-1X	71432-1X
1983 Bronco & F-150									
610168-1	Standard	3.00	707240-2X	706921X	706923X	706925X	72044-1X	71394-1X	71735-1X
610168-2	Standard	3.50	707240-5X	706921X	706923X	706925X	72044-1X	71394-1X	71735-1X
610168-3	Trac Lok	3.50	707240-5X	707147X	707148X	706926X	72044-1X	71394-1X	71735-1X
610168-4	Standard	3.00	707240-2X	706921X	706923X	706925X	72044-1X	71394-1X	71735-1X
610168-5	Standard	3.00	707240-2X	706921X	706923X	706925X	72044-1X	71394-1X	71735-1X
610168-6	Standard	3.50	707240-5X	706921X	706923X	706925X	72044-1X	71394-1X	71735-1X
610168-7	Standard	3.50	707240-5X	706921X	706923X	706925X	72044-1X	71394-1X	71735-1X
610168-8	Trac Lok	3.50	707240-5X	707147X	707148X	706926X	72044-1X	71394-1X	71735-1X
610168-9	Standard	3.07	707240-3X	706921X	706923X	706925X	72044-1X	71394-1X	71735-1X
610168-10	Standard	3.07	707240-3X	706921X	706923X	706925X	72044-1X	71394-1X	71735-1X
610168-11	Trac Lok	3.54	707240-6X	707147X	707148X	706926X	72044-1X	71394-1X	71735-1X
610168-12	Standard	3.54	707240-6X	706921X	706923X	706925X	72044-1X	71394-1X	71735-1X
610168-13	Standard	3.54	707240-6X	706921X	706923X	706925X	72044-1X	71394-1X	71735-1X
1983 F-150 Snow Plow									
610167-2	Standard	3.50	707240-5X	706921X	706923X	706925X	72044-1X	71394-1X	71735-1X
610167-4	Standard	3.54	707240-6X	706921X	706923X	706925X	72044-1X	71394-1X	71735-1X
1983 F-250 & F-350 HD									
610169-1	Standard	3.00	707240-2X	706921X	706923X	706925X	72045-1X	71396-1X	71739-1X
610169-2	Standard	3.54	707240-6X	706921X	706923X	706925X	72045-1X	71396-1X	71739-1X
610169-3	Standard	3.00	707240-2X	706921X	706923X	706925X	72045-1X	71396-1X	71739-1X
610169-4	Standard	3.54	707240-6X	706921X	706923X	706925X	72045-1X	71396-1X	71739-1X
610169-5	Standard	3.54	707240-6X	706921X	706923X	706925X	72045-1X	71396-1X	71739-1X
610169-6	Standard	4.09	707240-9X	706945X	706947X	706925X	72045-1X	71396-1X	71739-1X
610169-7	Trac Lok	3.54	707240-6X	707147X	707148X	706926X	72045-1X	71396-1X	71739-1X
1984 Bronco & F-150									
610178-1	Standard	3.07	707240-3X	706921X	706923X	706925X	72044-1X	71394-1X	72041-1X
610178-2	Standard	3.07	707240-3X	706921X	706923X	706925X	72044-1X	71394-1X	72041-1X
610178-3	Trac Lok	3.54	707240-6X	707147X	707148X	706926X	72044-1X	71394-1X	72041-1X
610178-4	Standard	3.54	707240-6X	706921X	706923X	706925X	72044-1X	71394-1X	72041-1X
610178-5	Standard	3.54	707240-6X	706921X	706923X	706925X	72044-1X	71394-1X	72041-1X
610178-9	Standard	3.07	707240-3X	706921X	706923X	706925X	72044-1X	71394-1X	72041-1X
610178-10	Standard	3.07	707240-3X	706921X	706923X	706925X	72044-1X	71394-1X	72041-1X
610178-11	Trac Lok	3.54	707240-6X	707147X	707148X	706926X	72044-1X	71394-1X	72041-1X
610178-12	Trac Lok	3.54	707240-6X	707147X	707148X	706926X	72044-1X	71394-1X	72041-1X
610178-13	Trac Lok	3.54	707240-6X	707147X	707148X	706926X	72044-1X	71394-1X	72041-1X

(7) See Ring Gear & Pinion Kits in XGI Catalog for ratio & tooth combinations.

(8) See Differential Case Assy Kits in XGI Catalog for spline data & ratios.

Ford Model 44 /216 IFS Front Axles

Bill of Material Table

Axle			Axle Kits				Shaft & Joint Assy.		
Bill of Material	Diff. Type	Ratio	Ring Gear & Pinion Kit ⁽⁷⁾	Differential			Right Hand Shaft Assy.	Left Hand Shaft Assy.	Shaft & Slip Yoke Assy.
				Case Assy. Kit ⁽⁸⁾	Case Kit	Inner Parts Kit			
1984 F-150 Snow Plow									
610177-1	Standard	3.54	707240-6X	706921X	706923X	706925X	72044-1X	71394-1X	72041-1X
610177-4	Standard	3.54	707240-6X	706921X	706923X	706925X	72044-1X	71394-1X	72041-1X
1984 F-250 & F-350 HD									
610179-1	Standard	3.54	707240-6X	706921X	706923X	706925X	72045-1X	71396-1X	72041-1X
610179-2	Standard	3.54	707240-6X	706921X	706923X	706925X	72045-1X	71396-1X	72041-1X
610179-3	Standard	3.54	707240-6X	706921X	706923X	706925X	72045-1X	71396-1X	72041-1X
610179-4	Standard	3.54	707240-6X	706921X	706923X	706925X	72045-1X	71396-1X	72041-1X
610179-5	Standard	3.54	707240-6X	706921X	706923X	706925X	72045-1X	71396-1X	72041-1X
610179-6	Standard	4.09	707240-9X	706945X	706947X	706925X	72045-1X	71396-1X	72041-1X
610179-7	Trac Lok	3.54	707240-6X	707147X	707148X	706926X	72045-1X	71396-1X	72041-1X
610179-8	Trac Lok	3.54	707240-6X	707147X	707148X	706926X	72045-1X	71396-1X	72041-1X
1984 1/2-85 Bronco & F-150									
610198-1	Standard	3.07	707240-3X	706921X	706923X	706925X	72044-1X	71394-1X	72041-1X
610198-2	Standard	3.07	707240-3X	706921X	706923X	706925X	72044-1X	71394-1X	72041-1X
610198-3	Trac Lok	3.54	707240-6X	707147X	707148X	706926X	72044-1X	71394-1X	72041-1X
610198-4	Standard	3.54	707240-6X	706921X	706923X	706925X	72044-1X	71394-1X	72041-1X
610198-5	Standard	3.54	707240-6X	706921X	706923X	706925X	72044-1X	71394-1X	72041-1X
610198-9	Standard	3.07	707240-3X	706921X	706923X	706925X	72044-1X	71394-1X	72041-1X
610198-10	Standard	3.07	707240-3X	706921X	706923X	706925X	72044-1X	71394-1X	72041-1X
610198-11	Trac Lok	3.54	707240-6X	707147X	707148X	706926X	72044-1X	71394-1X	72041-1X
610198-12	Standard	3.54	707240-6X	706921X	706923X	706925X	72044-1X	71394-1X	72041-1X
610198-13	Standard	3.54	707240-6X	706921X	706923X	706925X	72044-1X	71394-1X	72041-1X
610198-14	Standard	3.50	707240-5X	706921X	706923X	706925X	72044-1X	71394-1X	72041-1X
610198-15	Standard	3.50	707240-5X	706921X	706923X	706925X	72044-1X	71394-1X	72041-1X
610198-16	Trac Lok	3.50	707240-5X	707147X	707148X	706926X	72044-1X	71394-1X	72041-1X
610198-17	Standard	4.09	707240-9X	706945X	706947X	706925X	72044-1X	71394-1X	72041-1X
610198-18	Trac Lok	4.09	707240-9X	707199X	707193X	706926X	72044-1X	71394-1X	72041-1X
1984 1/2-85 F-150 Snow Plow									
610197-1	Standard	3.54	707240-6X	706921X	706923X	706925X	72044-1X	71394-1X	72041-1X
610197-4	Standard	3.54	707240-6X	706921X	706923X	706925X	72044-1X	71394-1X	72041-1X
610197-5	Standard	3.50	707240-5X	706921X	706923X	706925X	72044-1X	71394-1X	72041-1X
1984 1/2-85 F-250									
610199-1	Standard	3.54	707240-6X	706921X	706923X	706925X	72045-1X	71396-1X	72041-1X
610199-2	Standard	3.54	707240-6X	706921X	706923X	706925X	72045-1X	71396-1X	72041-1X
610199-3	Standard	3.54	707240-6X	706921X	706923X	706925X	72045-1X	71396-1X	72041-1X
610199-4	Standard	3.54	707240-6X	706921X	706923X	706925X	72045-1X	71396-1X	72041-1X
610199-5	Standard	3.54	707240-6X	706921X	706923X	706925X	72045-1X	71396-1X	72041-1X
610199-6	Standard	4.09	707240-9X	706945X	706947X	706925X	72045-1X	71396-1X	72041-1X
610199-7	Trac Lok	3.54	707240-6X	707147X	707148X	706926X	72045-1X	71396-1X	72041-1X
610199-8	Standard	4.09	707240-9X	706945X	706947X	706925X	72045-1X	71396-1X	72041-1X
610199-9	Trac Lok	4.09	707240-9X	707199X	707193X	706926X	72045-1X	71396-1X	72041-1X
610199-10	Trac Lok	4.09	707240-9X	707199X	707193X	706926X	72045-1X	71396-1X	72041-1X
1985 F-250									
610229-1	Standard	3.54	707240-6X	706921X	706923X	706925X	72045-1X	71396-1X	72041-1X
610229-2	Standard	3.54	707240-6X	706921X	706923X	706925X	72045-1X	71396-1X	72041-1X
610229-3	Standard	3.54	707240-9X	706945X	706947X	706925X	72045-1X	71396-1X	72041-1X
610229-4	Trac Lok	3.54	707240-6X	707147X	707148X	706926X	72045-1X	71396-1X	72041-1X
610229-5	Standard	4.09	707240-9X	706945X	706947X	706925X	72045-1X	71396-1X	72041-1X
610229-6	Trac Lok	4.09	707240-9X	707199X	707193X	706926X	72045-1X	71396-1X	72041-1X

(7) See Ring Gear & Pinion Kits in XGI Catalog for ratio & tooth combinations.

(8) See Differential Case Assy Kits in XGI Catalog for spline data & ratios.

Ford Model 44 /216 IFS Front Axles

Bill of Material Table

Axle			Axle Kits				Shaft & Joint Assy.		
Bill of Material	Diff. Type	Ratio	Ring Gear & Pinion Kit ⁽⁷⁾	Differential			Right Hand Shaft Assy.	Left Hand Shaft Assy.	Shaft & Slip Yoke Assy.
				Case Assy. Kit ⁽⁸⁾	Case Kit	Inner Parts Kit			
1985 F-250 & F-350 HD									
610231-1	Standard	3.54	707240-6X	706921X	706923X	706925X	72045-1X	71396-1X	72041-1X
610231-2	Standard	3.54	707240-6X	706921X	706923X	706925X	72045-1X	71396-1X	72041-1X
610231-3	Standard	4.09	707240-9X	706945X	706947X	706925X	72045-1X	71396-1X	72041-1X
610231-4	Trac Lok	3.54	707240-6X	707147X	707148X	706926X	72045-1X	71396-1X	72041-1X
610231-5	Standard	4.09	707240-9X	706945X	706947X	706925X	72045-1X	71396-1X	72041-1X
610231-6	Trac Lok	4.09	707240-9X	707199X	707193X	706926X	72045-1X	71396-1X	72041-1X
1985 1/2 Bronco & F-150									
610241-1	Standard	3.07	707240-3X	706921X	706923X	706925X	72044-1X	71394-1X	72041-1X
610241-2	Trac Lok	3.54	707240-6X	707147X	707148X	706926X	72044-1X	71394-1X	72041-1X
610241-3	Standard	3.54	707240-6X	706921X	706923X	706925X	72044-1X	71394-1X	72041-1X
610241-4	Standard	3.50	707240-5X	706921X	706923X	706925X	72044-1X	71394-1X	72041-1X
610241-5	Trac Lok	3.50	707240-5X	707147X	707148X	706926X	72044-1X	71394-1X	72041-1X
610241-6	Standard	4.09	707240-9X	706945X	706947X	706925X	72044-1X	71394-1X	72041-1X
610241-7	Trac Lok	4.09	707240-9X	707199X	706982X	706926X	72044-1X	71394-1X	72041-1X
1985 1/2 F-150 Snow Plow									
610242-1	Standard	3.54	707240-6X	706921X	706923X	706925X	72044-1X	71394-1X	72041-1X
610242-2	Standard	3.50	707240-5X	706921X	706923X	706925X	72044-1X	71394-1X	72041-1X
1985 1/2 F-250									
610243-1	Standard	3.54	707240-6X	706921X	706923X	706925X	72045-1X	71396-1X	72041-1X
610243-2	Standard	3.54	707240-6X	706921X	706923X	706925X	72045-1X	71396-1X	72041-1X
610243-3	Standard	4.09	707240-9X	706945X	706947X	706925X	72045-1X	71396-1X	72041-1X
610243-4	Trac Lok	3.54	707240-6X	707147X	707148X	706926X	72045-1X	71396-1X	72041-1X
610243-5	Standard	4.09	707240-9X	706945X	706947X	706925X	72045-1X	71396-1X	72041-1X
610243-6	Trac Lok	4.09	707240-9X	707199X	706982X	706926X	72045-1X	71396-1X	72041-1X
1986 Bronco & F-150									
610261-1	Standard	3.07	707240-3X	706921X	706923X	706925X	72044-1X	71394-1X	72041-1X
610261-2	Standard	3.54	707240-6X	706921X	706923X	706925X	72044-1X	71394-1X	72041-1X
610261-3	Standard	3.50	707240-5X	706921X	706923X	706925X	72044-1X	71394-1X	72041-1X
610262-1	Standard	3.07	707240-3X	706921X	706923X	706925X	72044-1X	71394-1X	72041-1X
610262-2	Trac Lok	3.54	707240-6X	707147X	707148X	706926X	72044-1X	71394-1X	72041-1X
610262-3	Standard	3.54	707240-6X	706921X	706923X	706925X	72044-1X	71394-1X	72041-1X
610262-4	Standard	3.50	707240-5X	706921X	706923X	706925X	72044-1X	71394-1X	72041-1X
610262-5	Trac Lok	3.50	707240-5X	707147X	707148X	706926X	72044-1X	71394-1X	72041-1X
610262-6	Standard	4.09	707240-9X	706945X	706947X	706925X	72044-1X	71394-1X	72041-1X
610262-7	Trac Lok	4.09	707240-9X	707199X	706982X	706926X	72044-1X	71394-1X	72041-1X
1986 F-150 Snow Plow									
610263-1	Standard	3.54	707240-6X	706921X	706923X	706925X	72044-1X	71394-1X	72041-1X
610263-2	Standard	3.50	707240-5X	706921X	706923X	706925X	72044-1X	71394-1X	72041-1X
1986-87 F-250									
610264-1	Standard	3.54	707240-6X	706921X	706923X	706925X	72045-1X	71396-1X	72041-1X
610264-2	Standard	3.54	707240-6X	706921X	706932X	706925X	72045-1X	71396-1X	72041-1X
610264-3	Standard	4.09	707240-9X	706945X	706947X	706925X	72045-1X	71396-1X	72041-1X
610264-4	Trac Lok	3.54	707240-6X	707147X	707148X	706926X	72045-1X	71396-1X	72041-1X
610264-5	Standard	4.09	707240-9X	706945X	706947X	706925X	72045-1X	71396-1X	72041-1X
610264-6	Trac Lok	4.09	707240-9X	707199X	707193X	706926X	72045-1X	71396-1X	72041-1X

(7) See Ring Gear & Pinion Kits in XGI Catalog for ratio & tooth combinations.

(8) See Differential Case Assy Kits in XGI Catalog for spline data & ratios.

Ford Model 44 /216 IFS Front Axles

Bill of Material Table

Axle			Axle Kits				Shaft & Joint Assy.		
Bill of Material	Diff. Type	Ratio	Ring Gear & Pinion Kit ⁽⁷⁾	Differential			Right Hand Shaft Assy.	Left Hand Shaft Assy.	Shaft & Slip Yoke Assy.
				Case Assy. Kit ⁽⁸⁾	Case Kit	Inner Parts Kit			
1987-88 Bronco & F-150									
610267-1	Standard	3.07	707240-3X	706921X	706923X	706925X	73111-1X	73112-1X	72041-1X
610267-2	Trac Lok	3.54	707240-6X	707147X	707148X	706926X	73111-1X	73112-1X	72041-1X
610267-3	Standard	3.54	707240-6X	706921X	706923X	706925X	73111-1X	73112-1X	72041-1X
610267-4	Standard	3.50	706920-5X	706921X	706923X	706925X	73111-1X	73112-1X	72041-1X
610267-6	Standard	4.09	707240-9X	706945X	706947X	706925X	73111-1X	73112-1X	72041-1X
610268-1	Standard	3.07	707240-3X	706921X	706923X	706925X	72044-1X	71394-1X	72041-1X
610268-2	Standard	3.54	707240-6X	706921X	706923X	706925X	72044-1X	71394-1X	72041-1X
1987-88 F-150 Snow Plow									
610266-1	Standard	3.54	707240-6X	706921X	706923X	706925X	73111-1X	73112-1X	72041-1X
610266-2	Standard	3.50	707240-5X	706921X	706923X	706925X	73111-1X	73112-1X	72041-1X
1988 F-250									
610306-1	Standard	3.54	707240-6X	706921X	706923X	706925X	72045-1X	71396-1X	72041-1X
610306-2	Standard	4.09	707240-9X	706945X	706947X	706925X	72045-1X	71396-1X	72041-1X
1988 1/2 F-150 Snow Plow, Bronco									
610309-1	Standard	3.07	707240-3X	706921X	706923X	706925X	73111-1X	73112-1X	72041-1X
610309-2	Trac Lok	3.54	707240-6X	707147X	707148X	707149X	73111-1X	73112-1X	72041-1X
610309-3	Standard	3.54	707240-6X	706921X	706923X	706925X	73111-1X	73112-1X	72041-1X
610309-4	Standard	4.09	707240-9X	706945X	706947X	706925X	73111-1X	73112-1X	72041-1X
1988 1/2-91 Bronco & F-150									
610311-1	Standard	3.54	707240-6X	706921X	706923X	706925X	72045-1X	71396-1X	72041-1X
610311-2	Standard	4.09	707240-9X	706945X	706947X	706925X	72045-1X	71396-1X	72041-1X
1988 1/2-92 Bronco & F-150									
610310-1	Standard	3.07	707240-3X	706921X	706923X	706925X	72044-1X	71394-1X	72041-1X
610310-2	Standard	3.54	707240-6X	706921X	706923X	706925X	72044-1X	71394-1X	72041-1X
610335-1	Standard	3.07	707240-3X	706921X	706923X	706925X	72044-1X	71394-1X	72041-1X
610335-2	Trac Lok	3.54	707240-6X	707147X	707148X	707149X	72044-1X	71394-1X	72041-1X
610335-3	Standard	3.54	707240-6X	706921X	706923X	706925X	72044-1X	71394-1X	72041-1X
610335-4	Standard	4.09	707240-9X	706945X	706947X	706925X	72044-1X	71394-1X	72041-1X
1992 1/2 Bronco & F-150									
610407-1	Standard	3.07	707283-3X	706921X	706923X	706925X	72044-1X	71394-1X	72041-1X
610407-3	Standard	3.54	707283-6X	706921X	706923X	706925X	72044-1X	71394-1X	72041-1X
610408-1	Standard	3.07	707283-3X	706921X	706923X	706925X	72044-1X	71394-1X	72041-1X
610408-3	Standard	3.54	707283-6X	706921X	706923X	706925X	72044-1X	71394-1X	72041-1X
610408-4	Standard	4.09	707283-9X	706945X	706947X	706925X	72044-1X	71394-1X	72041-1X
610408-6	Trac Lok	3.54	707283-6X	707147X	707148X	707149X	72044-1X	71394-1X	72041-1X
610408-7	Standard	3.07	707283-3X	706921X	706923X	706925X	72044-1X	71394-1X	72041-1X
610408-9	Standard	3.54	707283-6X	706921X	706923X	706925X	72044-1X	71394-1X	72041-1X
1993-93 1/2 Bronco - ABS									
610411-1	Standard	3.07	707283-3X	706921X	706923X	706925X	74820-1X	74813-1X	72041-1X
610411-2	Trac Lok	3.54	707283-6X	707147X	707148X	707149X	74820-1X	74813-1X	72041-1X
610411-3	Standard	3.54	707283-6X	706921X	706923X	706925X	74820-1X	74813-1X	72041-1X
610411-4	Standard	4.09	707283-9X	706945X	706947X	706925X	74820-1X	74813-1X	72041-1X
610411-7	Standard	3.07	707283-3X	706921X	706923X	706925X	74820-1X	74813-1X	72041-1X
610411-8	Standard	3.54	707283-6X	706921X	706923X	706925X	74820-1X	74813-1X	72041-1X

(7) See Ring Gear & Pinion Kits in XGI Catalog for ratio & tooth combinations.

(8) See Differential Case Assy Kits in XGI Catalog for spline data & ratios.

Ford Model 44 /216 IFS Front Axles

Bill of Material Table

Axle			Axle Kits				Shaft & Joint Assy.		
Bill of Material	Diff. Type	Ratio	Ring Gear & Pinion Kit ⁽⁷⁾	Differential			Right Hand Shaft Assy.	Left Hand Shaft Assy.	Shaft & Slip Yoke Assy.
				Case Assy. Kit ⁽⁸⁾	Case Kit	Inner Parts Kit			
1993-93 1/2 Bronco & F-150									
610414-1	Standard	3.07	707283-3X	706921X	706923X	706925X	74820-1X	74813-1X	72041-1X
610414-3	Standard	3.54	707283-6X	706921X	706923X	706925X	74820-1X	74813-1X	72041-1X
610414-4	Standard	4.09	707283-9X	706945X	706947X	706925X	74820-1X	74813-1X	72041-1X
610414-6	Trac Lok	3.54	707283-6X	707147X	707148X	707149X	74820-1X	74813-1X	72041-1X
610414-7	Standard	3.07	707283-3X	706921X	706923X	706925X	74820-1X	74813-1X	72041-1X
610414-9	Standard	3.54	707283-6X	706921X	706923X	706925X	74820-1X	74813-1X	72041-1X
1994 Bronco - ABS									
610443-3	Standard	3.54	707283-6X	706921X	706923X	706925X	74820-1X	74813-1X	72041-1X
610443-9	Standard	3.54	707283-6X	706921X	706923X	706925X	74820-1X	74813-1X	72041-1X
610447-3	Standard	3.54	707283-6X	706921X	706923X	706925X	74820-1X	74813-1X	72041-1X
610447-9	Standard	3.54	707283-6X	706921X	706923X	706925X	74820-1X	74813-1X	72041-1X
610447-10	Standard	3.54	707283-6X	706921X	706923X	706925X	74820-1X	74813-1X	72041-1X
1994 Bronco & F-150									
610444-1	Standard	3.07	707283-3X	706921X	706923X	706925X	74820-1X	74813-1X	72041-1X
610444-2	Standard	3.31	707283-4X	706921X	706923X	706925X	74820-1X	74813-1X	72041-1X
610444-3	Standard	3.54	707283-6X	706921X	706923X	706925X	74820-1X	74813-1X	72041-1X
610444-4	Standard	4.09	707283-9X	706945X	706947X	706925X	74820-1X	74813-1X	72041-1X
610444-5	Trac Lok	3.31	707283-4X	707147X	707148X	707149X	74820-1X	74813-1X	72041-1X
610444-6	Trac Lok	3.54	707283-6X	707147X	707148X	707149X	74820-1X	74813-1X	72041-1X
610444-7	Standard	3.07	707283-3X	706921X	706923X	706925X	74820-1X	74813-1X	72041-1X
610444-8	Standard	3.31	707283-4X	706921X	706923X	706925X	74820-1X	74813-1X	72041-1X
610444-9	Standard	3.54	707283-6X	706921X	706923X	706925X	74820-1X	74813-1X	72041-1X
1995 Bronco & F-150									
610446-1	Standard	3.07	707283-3X	706921X	706923X	706925X	74820-1X	74813-1X	72041-1X
610446-2	Standard	3.31	707283-4X	706921X	706923X	706925X	74820-1X	74813-1X	72041-1X
610446-3	Standard	3.54	707283-6X	706921X	706923X	706925X	74820-1X	74813-1X	72041-1X
610446-5	Trac Lok	3.31	707283-4X	707147X	707148X	707149X	74820-1X	74813-1X	72041-1X
610446-6	Trac Lok	3.54	707283-6X	707147X	707148X	707149X	74820-1X	74813-1X	72041-1X
610446-10	Standard	3.07	707283-3X	706921X	706923X	706925X	74820-1X	74813-1X	72041-1X
610446-11	Standard	3.31	707283-4X	706921X	706923X	706925X	74820-1X	74813-1X	72041-1X
610446-12	Standard	3.54	707283-6X	706921X	706923X	706925X	74820-1X	74813-1X	72041-1X
1996 1/2 Bronco - ABS									
610608-1	Standard	3.54	707283-6X	707461X	706923X	706925X	74820-1X	74813-1X	72041-1X
610608-2	Standard	3.54	707283-6X	707461X	706923X	706925X	74820-1X	74813-1X	72041-1X
1996 1/2 Bronco & F-150									
610607-1	Standard	3.07	707283-3X	707461X	706923X	706925X	74820-1X	74813-1X	72041-1X
610607-2	Standard	3.31	707283-4X	707461X	706923X	706925X	74820-1X	74813-1X	72041-1X
610607-3	Standard	3.54	707283-6X	707461X	706923X	706925X	74820-1X	74813-1X	72041-1X
610607-4	Standard	4.09	707283-9X	706945X	706947X	706925X	74820-1X	74813-1X	72041-1X
610607-5	Trac Lok	3.31	707283-4X	707147X	707148X	707149X	74820-1X	74813-1X	72041-1X
610607-6	Trac Lok	3.54	707283-6X	707147X	707148X	707149X	74820-1X	74813-1X	72041-1X
610607-7	Standard	3.07	707283-3X	707461X	706923X	706925X	74820-1X	74813-1X	72041-1X
610607-8	Standard	3.31	707283-4X	707461X	706923X	706925X	74820-1X	74813-1X	72041-1X
610607-9	Standard	3.54	707283-6X	707461X	706923X	706925X	74820-1X	74813-1X	72041-1X

(7) See Ring Gear & Pinion Kits in XGI Catalog for ratio & tooth combinations.

(8) See Differential Case Assy Kits in XGI Catalog for spline data & ratios.

Ford Model 44 /216 IFS Front Axles Variable Parts Listing

Kits & Parts - Use With All Applications							
Description & Item Number (Refer to "Exploded View" at the front of this section)			Bills of Material				
			610062	610063	610146	610166	610167
1	Slinger Shim – Inner Pinion Bearing	5	30764	30764	30764	30764	30764
2	KIT – Inner Pinion Bearing	6	706031X	706031X	706031X	706031X	706031X
3	Baffle – Pinion Bearing	7	30765	30765	30765	30765	30765
4	Gear – Differential (std)	24	31487	31487	31487	31487	40194
5	Thrustwasher – Differential Gear (std)	27	32121	32121	32121	32121	32121
6	Slinger	33	36364	36364	36364	36364	36364
7	Oil Seal	34	38128	38128	38128	38128	38128
8	Spacer – Wheel Bearing Spindle	35	38106	38106	38106	38106	38106
9	Bolt – Hex	44	36326-1	36326-1	36326-1	36326-1	36326-1
10	Nut	45	500381-3	500381-3	500381-3	500381-3	500381-3
11	Stop Screw	46	31026-1	31026-1	31026-1	31026-1	31026-1
12	Seal – Needle Bearing	48	36361	36361	36361	36361	36361
13	Spindle	50	41928	41929	41929	41928	41928
14	KIT – Spindle Seal & Bearing	-	706527X	706527X	706527X	706527X	706527X
15	KIT – Spindle (33, 34, 35, 48, 49, 50)	-	707178X	707043X	707043X	707178X	707178X
16	Spindle Assembly (inc 48, 49, 50)	-	73182X	73183X	73183X	73182X	73182X
17	Lock Nut (qty 10)	51	35704	35704	35704	35704	35704
18	Oil Seal	52	40709	40709	40709	40709	40709
19	KIT – Inner Wheel Bearing	53	706110X	706690X	706690X	706110X	706110X
20	Nut & Pin Assembly	56	21588X	21588X	21588X	21588X	21588X
21	Lock Nut	57	36569	36569	39909	39909	39909
22	Spindle Nut	58	31139	31139	31139	31139	31139
23	Axle Shaft Retainer	59	—	—	—	—	—
24	Snap Ring	60	—	—	—	—	—
25	Snap Ring	61	620147	620147	620147	620147	620147
26	Snap Ring	62	620430	620430	620430	620430	620430
27	Screw – Socket Head (Hub Lok)	64	620432	45886	45886	45886	45886
28	KIT – Unit Bearing & Seal	-	700154	700154	700154	700154	706948X
29	Oil Seal	71	35938	35938	35938	35938	40773
30	Bearing	72	565909	565909	565909	565909	566121
31	Retainer – Oil Seal	N.I.	620435	620435	620435	620435	—
32	Retainer – Bearing Ring	N.I.	36121	36121	36121	36121	—
33	Wheel Bearing Retainer Assembly	84	—	—	—	—	—
34	PKG – Washer	N.I.	—	—	—	—	—

Ford Model 44 /216 IFS Front Axles

Variable Parts Listing

Kits & Parts - Use With All Applications							
Description & Item Number (Refer to "Exploded View" at the front of this section)			Bills of Material				
			610168	610169	610177 610178	610179	610185
1	Slinger Shim – Inner Pinion Bearing	5	30764	30764	30764	30764	30764
2	KIT – Inner Pinion Bearing	6	706031X	706031X	706031X	706031X	706031X
3	Baffle – Pinion Bearing	7	30765	30765	30765	30765	30765
4	Gear – Differential (std)	24	40194	40194	40194	40194	31487
5	Thrustwasher – Differential Gear (std)	27	32121	32121	32121	32121	32121
6	Slinger	33	36364	36364	36364	36364	36364
7	Oil Seal	34	38128	38128	38128	38128	38128
8	Spacer – Wheel Bearing Spindle	35	38106	38106	38106	38106	38106
9	Bolt – Hex	44	36326-1	36326-1	36326-1	36326-1	36326-1
10	Nut	45	500381-3	500381-3	500381-3	500381-3	500381-3
11	Stop Screw	46	31026-1	31026-1	31026-1	31026-1	31026-1
12	Seal – Needle Bearing	48	36361	36361	36361	36361	36361
13	Spindle	50	41928	41929	41928	41929	41928
14	KIT – Spindle Seal & Bearing	-	706527X	706527X	706527X	706527X	706527X
15	KIT – Spindle (33, 34, 35, 48, 49, 50)	-	707178X	707043X	707178X	707043X	707178X
16	Spindle Assembly (inc 48, 49, 50)	-	73182X	73183X	73182X	73183X	73182X
17	Lock Nut (qty 10)	51	35704	35704	35704	35704	35704
18	Oil Seal	52	40709	40709	40709	40709	40709
19	KIT – Inner Wheel Bearing	53	706110X	706690X	706110X	706690X	706110X
20	Nut & Pin Assembly	56	21588X	21588X	21588X	21588X	21588X
21	Lock Nut	57	39909	39909	39909	39909	39909
22	Spindle Nut	58	31139	31139	31139	31139	31139
23	Axle Shaft Retainer	59	—	—	—	—	—
24	Snap Ring	60	—	—	—	—	—
25	Snap Ring	61	620147	620147	620147	620147	620147
26	Snap Ring	62	620430	620430	620430	620430	620430
27	Screw – Socket Head (Hub Lok)	64	—	45886	45886	45886	45886
28	KIT – Unit Bearing & Seal	-	706948X	706948X	706948X	706948X	700154
29	Oil Seal	71	40773	40773	40773	40773	35938
30	Bearing	72	566121	566121	566121	566121	565909
31	Retainer – Oil Seal	N.I.	—	—	—	—	620435
32	Retainer – Bearing Ring	N.I.	—	—	—	—	36121
33	Wheel Bearing Retainer Assembly	84	—	—	—	—	—
34	PKG – Washer	N.I.	—	—	—	—	—

(See next page for additional bills of material)

Ford Model 44 /216 IFS Front Axles Variable Parts Listing

Kits & Parts - Use With All Applications							
Description & Item Number (Refer to "Exploded View" at the front of this section)			Bills of Material				
			610197 610198	610199 610229 610231	610241 610242 610243	610261	610262 610263
1	Slinger Shim – Inner Pinion Bearing	5	30764	30764	30764	30764	30764
2	KIT – Inner Pinion Bearing	6	706031X	706031X	706031X	706031X	706031X
3	Baffle – Pinion Bearing	7	30765	30765	30765	30765	30765
4	Gear – Differential (std)	24	40194	40194	40194	40194	40194
5	Thrustwasher – Differential Gear (std)	27	32121	32121	32121	32121	32121
6	Slinger	33	36364	36364	36364	36364	36364
7	Oil Seal	34	38128	38128	38128	38128	38128
8	Spacer – Wheel Bearing Spindle	35	38106	38106	38106	38106	38106
9	Bolt – Hex	44	36326-1	36326-1	36326-1	36326-1	36326-1
10	Nut	45	500381-3	500381-3	500381-3	500381-3	500381-3
11	Stop Screw	46	31026-1	31026-1	31026-1	31026-1	31026-1
12	Seal – Needle Bearing	48	36361	36361	36361	36361	36361
13	Spindle	50	41928	41929	41929	41928	41928
14	KIT – Spindle Seal & Bearing	-	706971X	706971X	706971X	706971X	706971X
15	KIT – Spindle (33, 34, 35, 48, 49, 50)	-	707178X	707043X	707043X	707178X	707178X
16	Spindle Assembly (inc 48, 49, 50)	-	73182X	73183X	73182X	73182X	73182X
17	Lock Nut (qty 10)	51	35704	35704	35704	35704	35704
18	Oil Seal	52	40709	40709	40709	40709	40709
19	KIT – Inner Wheel Bearing	53	706110X	706690X	706110X	706110X	706110X
20	Nut & Pin Assembly	56	21588X	21588X	21588X	21588X	42390
21	Lock Nut	57	39909	39909	—	39909	—
22	Spindle Nut	58	31139	31139	—	31139	—
23	Axle Shaft Retainer	59	—	—	—	39907	—
24	Snap Ring	60	—	—	—	39908	—
25	Snap Ring	61	620147	620147	620147	—	620147
26	Snap Ring	62	620430	620430	620430	—	620430
27	Screw – Socket Head (Hub Lok)	64	45886	45886	45886	—	45886
28	KIT – Unit Bearing & Seal	-	706948X	706948X	706948X	706948X	706948X
29	Oil Seal	71	40773	40773	40773	40773	40773
30	Bearing	72	566121	566121	566121	566121	566121
31	Retainer – Oil Seal	N.I.	—	—	—	—	—
32	Retainer – Bearing Ring	N.I.	—	—	—	—	—
33	Wheel Bearing Retainer Assembly	84	—	—	—	—	—
34	PKG – Washer	N.I.	—	—	—	—	—

Ford Model 44 /216 IFS Front Axles Variable Parts Listing

Kits & Parts - Use With All Applications							
Description & Item Number (Refer to "Exploded View" at the front of this section)			Bills of Material				
			610264	610266	610267	610268	610306
1	Slinger Shim – Inner Pinion Bearing	5	30764	30764	30764	30764	30764
2	KIT – Inner Pinion Bearing	6	706031X	706031X	706031X	706031X	706031X
3	Baffle – Pinion Bearing	7	30765	30765	30765	30765	30765
4	Gear – Differential (std)	24	40194	40194	40194	40194	40194
5	Thrustwasher – Differential Gear (std)	27	32121	32121	32121	32121	32121
6	Slinger	33	36364	36364	36364	36364	36364
7	Oil Seal	34	38128	38128	38128	38128	38128
8	Spacer – Wheel Bearing Spindle	35	38106	38106	38106	38106	38106
9	Bolt – Hex	44	36326-1	36326-1	36326-1	36326-1	36326-1
10	Nut	45	500381-3	500381-3	500381-3	500381-3	500381-3
11	Stop Screw	46	31026-1	31026-1	31026-1	31026-1	31026-1
12	Seal – Needle Bearing	48	36361	36361	36361	36361	36361
13	Spindle	50	41929	41928	42348	41928	41929
14	KIT – Spindle Seal & Bearing	-	706971X	706971X	706971X	706971X	706971X
15	KIT – Spindle (33, 34, 35, 48, 49, 50)	-	707043X	707059X	707059X	707178X	707043X
16	Spindle Assembly (inc 48, 49, 50)	-	73183X	73110X	73110X	73182X	73183X
17	Lock Nut (qty 10)	51	35704	35704	35704	35704	35704
18	Oil Seal	52	40709	40709	40709	40709	40709
19	KIT – Inner Wheel Bearing	53	706690X	706110X	706074X	706110X	706690X
20	Nut & Pin Assembly	56	43167	43167	43167	21588X	43167
21	Lock Nut	57	—	—	—	39909	—
22	Spindle Nut	58	—	—	—	31139	—
23	Axle Shaft Retainer	59	—	39907	39907	39907	—
24	Snap Ring	60	—	39908	39908	39908	—
25	Snap Ring	61	620147	—	—	—	620147
26	Snap Ring	62	620430	—	—	—	620430
27	Screw – Socket Head (Hub Lok)	64	45886	45886	45886	—	45886
28	KIT – Unit Bearing & Seal	-	706948X	706948X	706948X	706948X	706948X
29	Oil Seal	71	40773	40773	40773	40773	40773
30	Bearing	72	566121	566121	566121	566121	566121
31	Retainer – Oil Seal	N.I.	—	—	—	—	—
32	Retainer – Bearing Ring	N.I.	—	—	—	—	—
33	Wheel Bearing Retainer Assembly	84	—	—	—	—	—
34	PKG – Washer	N.I.	—	—	—	—	—

(See next page for additional bills of material)

Ford Model 44 /216 IFS Front Axles Variable Parts Listing

Kits & Parts - Use With All Applications							
Description & Item Number (Refer to "Exploded View" at the front of this section)			Bills of Material				
			610309	610310	610311	610335	610407
1	Slinger Shim – Inner Pinion Bearing	5	30764	30764	30764	30764	—
2	KIT – Inner Pinion Bearing	6	706031X	706031X	706031X	706031X	706015X
3	Baffle – Pinion Bearing	7	30765	30765	30765	30765	32349
4	Gear – Differential (std)	24	40194	40194	40194	40194	40194
5	Thrustwasher – Differential Gear (std)	27	32121	32121	32121	32121	40196
6	Slinger	33	36364	36364	36364	36364	36364
7	Oil Seal	34	38128	38128	38128	38128	38128
8	Spacer – Wheel Bearing Spindle	35	38106	38106	38106	38106	38106
9	Bolt – Hex	44	36326-1	36326-1	36326-1	36326-1	36326-1
10	Nut	45	500381-3	500381-3	500381-3	500381-3	500381-3
11	Stop Screw	46	31026-1	31026-1	31026-1	31026-1	31026-1
12	Seal – Needle Bearing	48	36361	36361	36361	36361	36361
13	Spindle	50	42348	41928	41929	41928	41928
14	KIT – Spindle Seal & Bearing	-	706971X	706971X	706971X	706971X	706971X
15	KIT – Spindle (33, 34, 35, 48, 49, 50)	-	707059X	707178X	707043X	707178X	707178X
16	Spindle Assembly (inc 48, 49, 50)	-	73110X	73182X	73183X	73182X	73182X
17	Lock Nut (qty 10)	51	35704	35704	35704	35704	35704
18	Oil Seal	52	40709	40709	40709	40709	40709
19	KIT – Inner Wheel Bearing	53	706074X	706110X	706690X	706110X	706110X
20	Nut & Pin Assembly	56	43167	21588X	43167	43167	21588X
21	Lock Nut	57	—	39909	—	—	39909
22	Spindle Nut	58	—	31139	—	—	31139
23	Axle Shaft Retainer	59	39907	39907	—	—	39907
24	Snap Ring	60	39908	39908	—	—	39908
25	Snap Ring	61	—	—	620147	620147	—
26	Snap Ring	62	—	—	620430	620430	—
27	Screw – Socket Head (Hub Lok)	64	45886	—	45886	45886	—
28	KIT – Unit Bearing & Seal	-	706948X	706948X	706948X	706948X	706948X
29	Oil Seal	71	40773	40773	40773	40773	40773
30	Bearing	72	566121	566121	566121	566121	566121
31	Retainer – Oil Seal	N.I.	—	—	—	—	—
32	Retainer – Bearing Ring	N.I.	—	—	—	—	—
33	Wheel Bearing Retainer Assembly	84	—	—	—	—	—
34	PKG – Washer	N.I.	—	—	—	—	—

Ford Model 44 /216 IFS Front Axles Variable Parts Listing

Kits & Parts - Use With All Applications							
Description & Item Number (Refer to "Exploded View" at the front of this section)			Bills of Material				
			610408	610411	610414	610443	610444
1	Slinger Shim – Inner Pinion Bearing	5	—	—	—	—	—
2	KIT – Inner Pinion Bearing	6	706015X	706015X	706015X	706015X	706015X
3	Baffle – Pinion Bearing	7	32349	32349	32349	32349	32349
4	Gear – Differential (std)	24	40194	40194	40194	40194	40194
5	Thrustwasher – Differential Gear (std)	27	40196	40196	40196	40196	40196
6	Slinger	33	36364	—	—	—	—
7	Oil Seal	34	38128	50492	50492	50492	50492
8	Spacer – Wheel Bearing Spindle	35	38106	—	—	—	—
9	Bolt – Hex	44	36326-1	44630-1	44630-1	44630-1	44630-1
10	Nut	45	500381-3	—	—	—	—
11	Stop Screw	46	31026-1	—	—	—	—
12	Seal – Needle Bearing	48	36361	45651	45651	45651	45651
13	Spindle	50	41928	44610	44706	44610	44706
14	KIT – Spindle Seal & Bearing	-	706971X	707316X	707316X	707316X	707316X
15	KIT – Spindle (33, 34, 35, 48, 49, 50)	-	707178X	—	707373X	—	707373X
16	Spindle Assembly (inc 48, 49, 50)	-	73182X	74811X	74812X	74811X	74812X
17	Lock Nut (qty 10)	51	35704	36805	36805	36805	36805
18	Oil Seal	52	40709	40709	40709	40709	40709
19	KIT – Inner Wheel Bearing	53	706110X	706110X	706110X	706110X	706110X
20	Nut & Pin Assembly	56	—	—	—	—	—
21	Lock Nut	57	—	—	—	—	—
22	Spindle Nut	58	—	—	—	—	—
23	Axle Shaft Retainer	59	—	—	—	—	—
24	Snap Ring	60	—	—	—	—	—
25	Snap Ring	61	620147	620147	620147	620147	620147
26	Snap Ring	62	620430	620430	620430	620430	620430
27	Screw – Socket Head (Hub Lok)	64	45886	45886	45886	45886	45886
28	KIT – Unit Bearing & Seal	-	706948X	706948X	706948X	706948X	706948X
29	Oil Seal	71	40773	40773	40773	40773	40773
30	Bearing	72	566121	566121	566121	566121	566121
31	Retainer – Oil Seal	N.I.	—	—	—	—	—
32	Retainer – Bearing Ring	N.I.	—	—	—	—	—
33	Wheel Bearing Retainer Assembly	84	43167	43167	43167	43167	43167
34	PKG – Washer	N.I.	—	—	—	—	—

(See next page for additional bills of material)

Ford Model 44 /216 IFS Front Axles Variable Parts Listing

Kits & Parts - Use With All Applications						
Description & Item Number (Refer to "Exploded View" at the front of this section)			Bills of Material			
			610446	610447	610607	610608
1	Slinger Shim – Inner Pinion Bearing	5	—	—	—	—
2	KIT – Inner Pinion Bearing	6	706015X	706015X	706015X	706015X
3	Baffle – Pinion Bearing	7	32349	32349	32349	32349
4	Gear – Differential (std)	24	40194	40194	40194	40194
5	Thrustwasher – Differential Gear (std)	27	40196	40196	40196	40196
6	Slinger	33	—	—	—	—
7	Seal – Oil	34	50492	50492	50492	50492
8	Spacer – Wheel Bearing Spindle	35	—	—	—	—
9	Bolt – Hex	44	44630-1	44630-1	44630-1	46630-1
10	Nut	45	—	—	—	—
11	Stop Screw	46	—	—	—	—
12	Seal – Needle Bearing	48	45651	45651	45651	45651
13	Spindle	50	46319	46320	46319	46320
14	KIT – Spindle Seal & Bearing	-	707316X	707316X	707316X	707316X
15	KIT – Spindle (33, 34, 35, 48, 49, 50)	-	—	—	—	—
16	Spindle Assembly (inc 48, 49, 50)	-	75303X	75304X	75303X	75304X
17	Lock Nut (qty 10)	51	36805	36805	36805	36805
18	Seal – Oil	52	76267X	76267X	76267X	76267X
19	KIT – Inner Wheel Bearing	53	706110X	706110X	706110X	706110X
20	Nut & Pin Assembly	56	21588X	—	21588X	21588X
21	Lock Nut	57	39909	—	39909	39909
22	Spindle Nut	58	31139	—	31139	31139
23	Axle Shaft Retainer	59	—	—	—	—
24	Snap Ring	60	39908	—	39908	39908
25	Snap Ring	61	—	—	—	—
26	Snap Ring	62	620430	620430	620430	620430
27	Screw – Socket Head (Hub Lok)	64	46481	45886	46481	46481
28	KIT – Unit Bearing & Seal	-	706948X	706948X	706948X	706948X
29	Oil Seal	71	40773	40773	40773	40773
30	Bearing	72	566121	566121	566121	566121
31	Retainer – Oil Seal	N.I.	—	—	—	—
32	Retainer – Bearing Ring	N.I.	—	—	—	—
33	Wheel Bearing Retainer Assembly	84	—	—	—	—
34	PKG – Washer	N.I.	701131X	—	701131X	701131X

Ford 1980-1998

Model 50 /229 IFS Front Axles for

F-250, F-350

Ford Model 50 /229 IFS Front Axles Exploded View

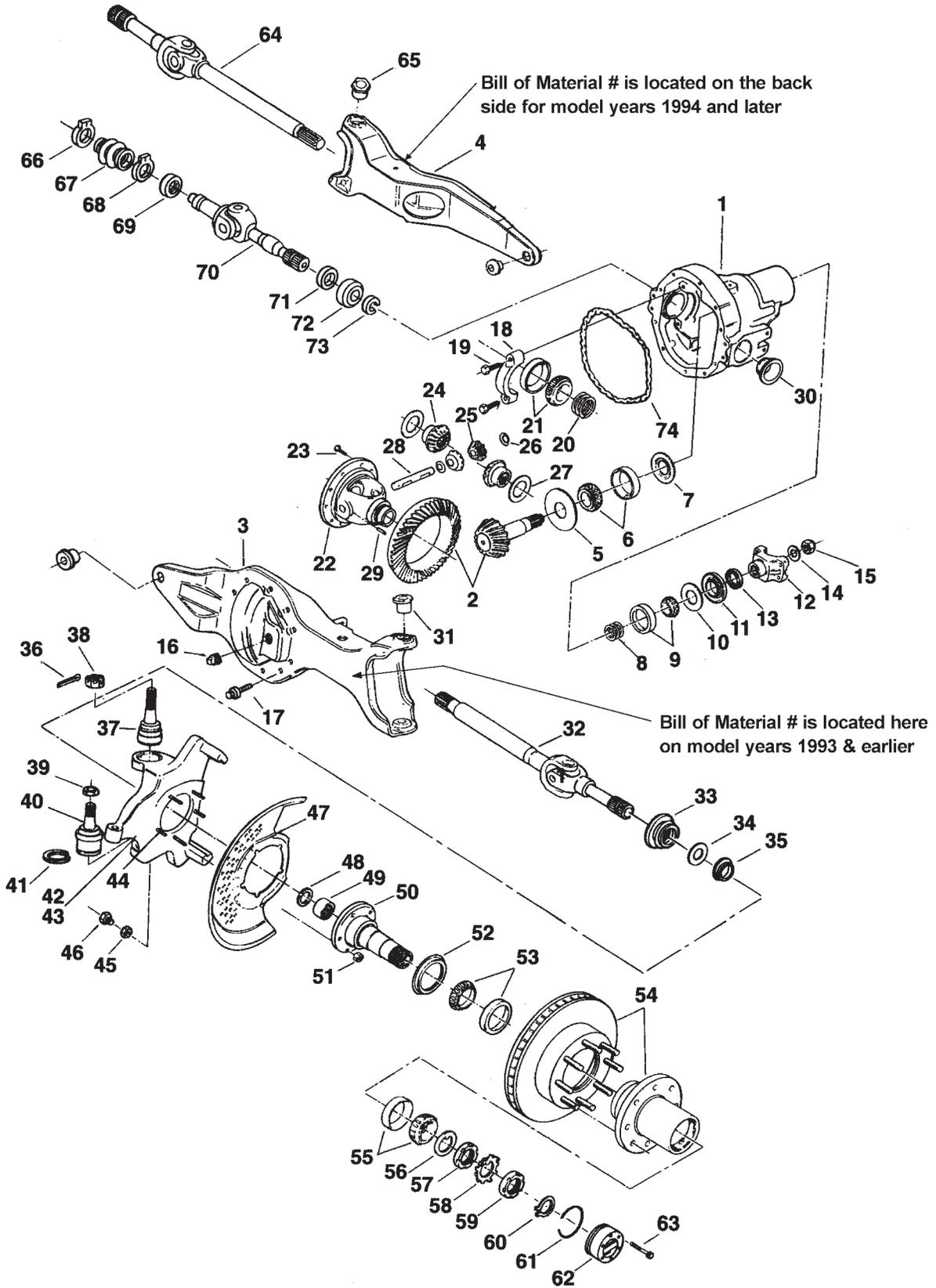

Ford Model 50 /229 IFS Front Axles

Parts Listing

ITEM NO.	PART NUMBER	DESCRIPTION	ITEM NO.	PART NUMBER	DESCRIPTION
1	— ⁽³⁾	Housing – Axle Service	39	35566	Nut – Lower
2	— ⁽¹⁾	Drive Pinion & Gear Assembly	40	47183	Socket – Lower
3	— ⁽³⁾	LH Support Arm Assembly	41	620343	Snap Ring
4	— ⁽³⁾	RH Support Arm Assembly	42	— ⁽³⁾	Right Knuckle
5	— ⁽²⁾	Slinger Shim – Inner Pinion Bearing	43	— ⁽³⁾	Left Knuckle
	707237X	PKG – Pinion Bearing Shim (inc items 8, 13, 14, 72)	44	37759-1	Bolt – Hex
	707235X	PKG – Diff & Pinion Bearing Shim (inc items 8, 13, 14, 19, 72)	45	— ⁽²⁾	Nut
			46	— ⁽²⁾	Stop Screw
			47	— ⁽³⁾	Dust Shield
6	706015X	KIT – Inner Pinion Bearing	48	— ⁽²⁾	Seal – Needle Bearing
7	32349	Baffle – Pinion Bearing	49	620063	Needle Bearing – Spindle
8	— ⁽⁴⁾	Outer Pinion Adj Shims (see shim packages)	50	620370	Spindle
				— ⁽²⁾	KIT – Spindle Seal & Bearing (inc items 34, 35, 48, 49)
9	706030X	KIT – Outer Pinion Bearing			
10	13575	Slinger – Outer Pinion Bearing	51	36805	Lock Nut (qty 10)
11	40793	Seal – Pinion Oil	52	— ⁽²⁾	Seal – Grease
12	2-4-6111X	End Yoke Assembly (inc 13)	53	706411X	KIT – Inner Wheel Bearing
13	41498	Slinger – End Yoke	54	— ⁽³⁾	Hub & Rotor
14	30186	Washer – Pinion Nut	55	706074X	KIT – Outer Wheel Bearing
15	30185	Pinion Nut	56	— ⁽²⁾	Thrustwasher – Wheel Bearing
16	36472	Plug – Oil Fill	57	— ⁽²⁾	Spindle Nut or Nut & Pin Assembly
17	620631	Bolt – Carrier	58	— ⁽²⁾	Lockwasher
18	— ⁽³⁾	Differential Bearing Cap	59	— ⁽²⁾	Spindle Nut
19	48632-1	Screw – Differential Bearing Cap	60	620142	Snap Ring
20	706914X	PKG – Diff Bearing Shim (inc 72)	61	620097	Snap Ring
21	700097	KIT – Differential Bearing		— ⁽³⁾	PKG – Thrustwasher (auto hub lock)
22	— ⁽⁴⁾	Case – Differential	62	— ⁽³⁾	Hub Lock
23	45784	Bolt – Drive Gear	63	45886	Bolt – Manual Hub Lock
24	40432	Gear – Differential	64	— ⁽¹⁾	Shaft & Joint Assembly (RH)
25	620436	Pinion – Differential	65	— ⁽⁵⁾	Camber Adjustor
26	620439	Thrustwasher – Differential Pinion	66	40540-4	Clamp – Keystone
27	50718	Thrustwasher – Differential Gear	67	40929	Rubber Boot
28	620414	Shaft – Differential	68	40540-3	Clamp – Keystone
29	44810	Lock – Differential Shaft	69	40930	Oil Seal
30	40710	Oil Seal	70	— ⁽¹⁾	Shaft & Slip Yoke Assembly
31	— ⁽⁵⁾	Camber Adjustor (LH)		— ⁽²⁾	KIT – Unit Bearing & Seal
32	— ⁽¹⁾	Shaft & Joint Assembly (LH)			(inc items 71, 72)
33	— ⁽²⁾	Slinger	71	— ⁽²⁾	Oil Seal
34	— ⁽²⁾	Oil Seal	72	— ⁽²⁾	Bearing
35	— ⁽²⁾	Spacer – Wheel Bearing Spindle	73	42570	Snap Ring
	700103-1X	KIT – Socket Assembly (inc items 36, 37, 38, 39, 40, 41)	74	38615	RTV Silicone Sealant
					The following parts were used in vehicles from 1982 and earlier.
36	500024-8	Cotter Pin			Retainer – Bearing Ring
37	47184	Socket – Upper	N.I.	— ⁽²⁾	Retainer – Oil Seal
38	44101	Nut – Upper	N.I.	— ⁽²⁾	

N.I. = Not Illustrated

(1) See "Bill of Material Table" on next page

(2) See "Variable Parts Table" within this section

(3) Contact Vehicle Manufacturer

(4) Not Sold Separately

(5) See Camber/Casting Bushing Table at the back of the Ford section of this catalog

Ford Model 50 /229 IFS Front Axles

Bill of Material Table

Axle			Axle Kits				Shaft & Joint Assy.		
Bill of Material	Diff. Type	Ratio	Ring Gear & Pinion Kit ⁽⁷⁾	Differential			Right Hand Shaft Assy.	Left Hand Shaft Assy.	Shaft & Slip Yoke Assy.
				Case Assy. Kit ⁽⁸⁾	Case Kit	Inner Parts Kit			
1980 F-350									
610064-1	Standard	3.54	707239-1X	707459X	706917X	706916X	74445-1X	74446-1X	660232-1
610064-2	Standard	4.10	707239-2X	707459X	706917X	706916X	74445-1X	74446-1X	660232-1
610064-3	Standard	3.54	707239-1X	707459X	706917X	706916X	74445-1X	74446-1X	660232-1
1981-82 F-250 & F-350 (Snow Fighter)									
610147-1	Standard	3.54	707239-1X	707459X	706917X	706916X	74445-1X	74446-1X	660232-1
610147-2	Standard	4.10	707239-2X	707459X	706917X	706916X	74445-1X	74446-1X	660232-1
610147-3	Standard	3.54	707239-1X	707459X	706917X	706916X	74445-1X	74446-1X	660232-1
610147-4	Standard	3.54	707239-1X	707459X	706917X	706916X	74445-1X	74446-1X	660232-1
1983 F-250									
610170-1	Standard	4.10	707239-2X	707459X	706917X	706916X	74445-1X	74446-1X	71738-1X
610170-2	Standard	3.54	707239-1X	707459X	706917X	706916X	74445-1X	74446-1X	71738-1X
610170-3	Standard	3.54	707239-1X	707459X	706917X	706916X	74445-1X	74446-1X	71738-1X
1984 F-250 & F-350 (Snow Fighter)									
610180-1	Standard	3.54	707239-1X	707459X	706917X	706916X	74445-1X	74446-1X	72043-1X
610180-2	Standard	4.10	707239-2X	707459X	706917X	706916X	74445-1X	74446-1X	72043-1X
610180-3	Standard	3.54	707239-1X	707459X	706917X	706916X	74445-1X	74446-1X	72043-1X
1984 1/2 F-250 & F-350 (Snow Fighter)									
610200-1	Standard	3.54	707239-1X	707459X	706917X	706916X	74445-1X	74446-1X	72043-1X
610200-2	Standard	4.10	707239-2X	707459X	706917X	706916X	74445-1X	74446-1X	72043-1X
610200-3	Standard	3.54	707239-1X	707459X	706917X	706916X	74445-1X	74446-1X	72043-1X
610200-4	Standard	4.10	707239-2X	707459X	706917X	706916X	74445-1X	74446-1X	72043-1X
1985 F-250 & F-350 (Snow Fighter)									
610230-1	Standard	3.54	707239-1X	707459X	706917X	706916X	74445-1X	74446-1X	72043-1X
610230-2	Standard	4.10	707239-2X	707459X	706917X	706916X	74445-1X	74446-1X	72043-1X
610230-3	Standard	3.54	707239-1X	707459X	706917X	706916X	74445-1X	74446-1X	72043-1X
610230-4	Standard	4.10	707239-2X	707459X	706917X	706916X	74445-1X	74446-1X	72043-1X
1985 1/2 F-350									
610232-1	Standard	3.54	707239-1X	707459X	706917X	706916X	74445-1X	74446-1X	72043-1X
610232-2	Standard	4.10	707239-2X	707459X	706917X	706916X	74445-1X	74446-1X	72043-1X
610232-3	Standard	3.54	707239-1X	707459X	706917X	706916X	74445-1X	74446-1X	72043-1X
610232-4	Standard	4.10	707239-2X	707459X	706917X	706916X	74445-1X	74446-1X	72043-1X
1986-87 F-250 & F-350 (Snow Fighter)									
610254-1	Standard	3.54	707239-1X	707459X	706917X	706916X	74445-1X	74446-1X	72043-1X
610254-2	Standard	4.10	707239-2X	707459X	706917X	706916X	74445-1X	74446-1X	72043-1X
610254-3	Standard	3.54	707239-1X	707459X	706917X	706916X	74445-1X	74446-1X	72043-1X
610254-4	Standard	4.10	707239-2X	707459X	706917X	706916X	74445-1X	74446-1X	72043-1X
1988-88 1/2 F-250 & F-350 (Snow Fighter)									
610304-1	Standard	3.54	707239-1X	707459X	706917X	706916X	74445-1X	74446-1X	72043-1X
610304-2	Standard	4.10	707239-2X	707459X	706917X	706916X	74445-1X	74446-1X	72043-1X
1989-92 1/2 F-250 & F-350 (Snow Fighter)									
610312-3	Standard	3.54	707239-1X	707459X	706917X	706916X	74445-1X	74446-1X	72043-1X
610312-4	Standard	4.10	707239-2X	707459X	706917X	706916X	74445-1X	74446-1X	72043-1X
1993-94 F-250 & F-350 (Snow Fighter)									
610439-1	Standard	3.54	707239-1X	707459X	706917X	706916X	74934-1X	74935-1X	72043-1X
610439-2	Standard	4.10	707239-2X	707459X	706917X	706916X	74934-1X	74935-1X	72043-1X
610439-3	Standard	3.54	707239-1X	707459X	706917X	706916X	74934-1X	74935-1X	72043-1X
610439-4	Standard	4.10	707239-2X	707459X	706917X	706916X	74934-1X	74935-1X	72043-1X

(7) See Ring Gear & Pinion Kits in XGI Catalog for ratio & tooth combinations.

(8) See Differential Case Assy Kits in XGI Catalog for spline data & ratios.

Ford Model 50 /229 IFS Front Axles Bill of Material Table

Axle			Axle Kits				Shaft & Joint Assy.		
Bill of Material	Diff. Type	Ratio	Ring Gear & Pinion Kit ⁽⁷⁾	Differential			Right Hand Shaft Assy.	Left Hand Shaft Assy.	Shaft & Slip Yoke Assy.
				Case Assy. Kit ⁽⁸⁾	Case Kit	Inner Parts Kit			
1995 F-250 & F-350 (Snow Fighter)									
610459-1	Standard	3.54	707239-1X	707459X	706917X	706916X	74934-1X	74935-1X	72043-1X
610459-2	Standard	4.10	707239-2X	707459X	706917X	706916X	74934-1X	74935-1X	72043-1X
610459-3	Standard	3.54	707239-1X	707459X	706917X	706916X	74934-1X	74935-1X	72043-1X
610459-4	Standard	4.10	707239-2X	707459X	706917X	706916X	74934-1X	74935-1X	72043-1X
610459-5	Standard	3.54	707239-1X	707459X	706917X	706916X	74934-1X	74935-1X	72043-1X
610459-6	Standard	4.10	707239-2X	707459X	706917X	706916X	74934-1X	74935-1X	72043-1X
610459-7	Standard	3.54	707239-1X	707459X	706917X	706916X	74934-1X	74935-1X	72043-1X
610459-8	Standard	4.10	707239-2X	707459X	706917X	706916X	74934-1X	74935-1X	72043-1X
1996 1/2-97 F-250 & F-350 (Snow Fighter)									
610609-1	Standard	3.54	707239-1X	707459X	706917X	706916X	74934-1X	74935-1X	72043-1X
610609-2	Standard	4.10	707239-2X	707459X	706917X	706916X	74934-1X	74935-1X	72043-1X
610609-3	Standard	3.54	707239-1X	707459X	706917X	706916X	74934-1X	74935-1X	72043-1X
610609-4	Standard	4.10	707239-2X	707459X	706917X	706916X	74934-1X	74935-1X	72043-1X
1997 1/2-98 F-250 & F-350 (Snow Fighter)									
610740-1	Standard	3.54	707239-1X	707459X	706917X	706916X	74934-1X	74935-1X	72043-1X
610740-2	Standard	4.10	707239-2X	707459X	706917X	706916X	74934-1X	74935-1X	72043-1X
610740-3	Standard	3.54	707239-1X	707459X	706917X	706916X	74934-1X	74935-1X	72043-1X
610740-4	Standard	4.10	707239-2X	707459X	706917X	706916X	74934-1X	74935-1X	72043-1X

(7) See Ring Gear & Pinion Kits in XGI Catalog for ratio & tooth combinations.

(8) See Differential Case Assy Kits in XGI Catalog for spline data & ratios.

Ford Model 50 /229 IFS Front Axles Variable Parts Listing

Kits & Parts - Use With All Applications							
Description & Item Number (Refer to "Exploded View" at the front of this section)			Bills of Material				
			610064	610147	610170 610180 610200 610230 610232 610254 610304	610312	610439
1	Slinger Shim – Inner Pinion Bearing	5	30764	30764	30764	—	—
2	Slinger	33	37308	37308	37308	37308	—
3	Oil Seal	34	37311	37311	37311	37311	50381
4	Spacer – Wheel Bearing Spindle	35	37312	37312	37312	37312	—
5	Nut	45	500381-5	500381-5	500381-5	500381-5	500381-5
6	Stop Screw	46	620143-2	620143-2	620143-2	620143-2	620143-2
7	Seal – Needle Bearing	48	620062	620062	620062	620062	44506
8	KIT – Spindle Seal & Bearing	-	700014	700014	700014	700014	708084
9	Seal – Grease	52	37729	37729	37729	37729	37729
10	Thrustwasher – Wheel Bearing	56	33734	—	—	—	—
11	Spindle Nut or Nut & Pin Assembly	57	33732	660568	660568	660568	660568
12	Lockwasher	58	33733	620128	621028	621028	621028
13	Spindle Nut	59	33732	621027	621027	621027	621027
14	KIT – Unit Bearing & Seal	-	700154	700154	706948X	706948X	706948X
15	Oil Seal	71	35938	35938	40773	40773	40773
16	Bearing	72	565909	565909	566121	566121	566121
17	Retainer – Bearing Ring	75	36121	36121	—	—	—
18	Retainer – Oil Seal	76	620435	620435	—	—	—
			610459	610609 610740			
1	Slinger Shim – Inner Pinion Bearing	5	—	—			
2	Slinger	33	—	—			
3	Oil Seal	34	50381	50381			
4	Spacer – Wheel Bearing Spindle	35	—	—			
5	Nut	45	—	—			
6	Stop Screw	46	—	—			
7	Seal – Needle Bearing	48	44506	44506			
8	KIT – Spindle Seal & Bearing	-	708084	708084			
9	Seal – Grease	52	37729	48816			
10	Thrustwasher – Wheel Bearing	56	—	—			
11	Spindle Nut or Nut & Pin Assembly	57	660568	660568			
12	Lockwasher	58	621028	621028			
13	Spindle Nut	59	621027	621027			
14	KIT – Unit Bearing & Seal	-	706948X	706948X			
15	Oil Seal	71	40773	40773			
16	Bearing	72	566121	566121			
17	Retainer – Bearing Ring (NI)	75	—	—			
18	Retainer – Oil Seal (NI)	76	—	—			

Ford 1990-1997

Model 28 /174 Front Axles for

Aerostar

Ford Model 28 /174 Front Axles Exploded View

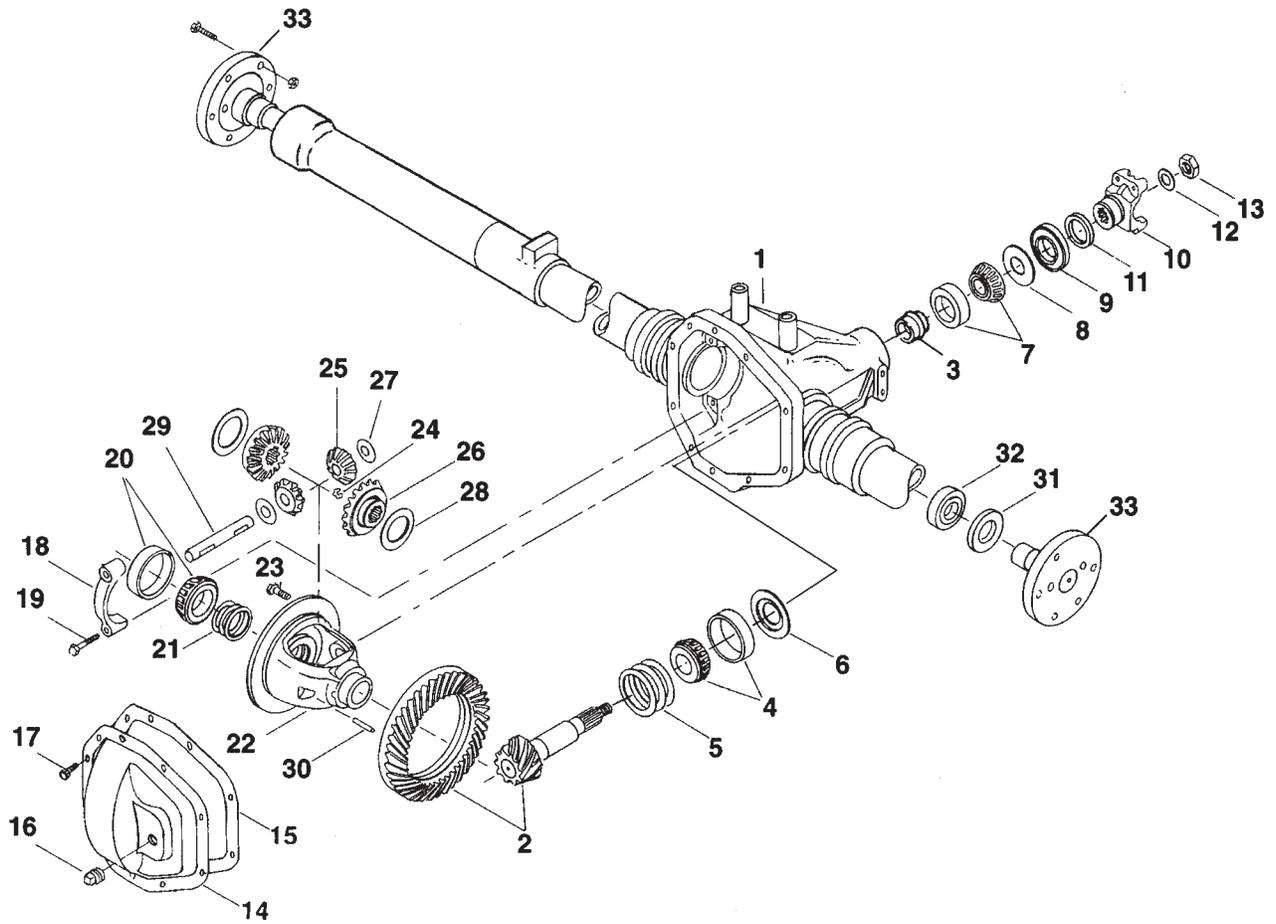

Ford Model 28 /174 Front Axles Parts Listing

ITEM NO.	PART NUMBER	DESCRIPTION	ITEM NO.	PART NUMBER	DESCRIPTION
1	— ⁽³⁾	Housing – Axle Service	15	38615	RTV Silicone Sealant
2	— ⁽¹⁾	Drive Pinion & Gear Assembly	16	41874	Plug – Carrier Cover
3	620878-1	Collapsible Spacer	17	40286-5	Bolt – Carrier Cover (qty 10)
	707223X	PKG – Diff & Pinion Bearing Shim (inc items 3, 5, 12, 13, 21, 24)	18	— ⁽⁴⁾	Cap – Differential Bearing
4	706123X	KIT – Inner Pinion Bearing	19	620752	Bolt – Differential Bearing Cap
5	— ⁽⁴⁾	Inner Pinion Bearing Shims (see shim packages)	20	706893X	KIT – Differential Bearing
	707222X	PKG – Inner Pinion Bearing Shim (inc items 3, 5, 12, 13, 24)	21	706896X	PKG – Diff Bearing Shim (inc 15, 24)
6	43734	Baffle	22	— ⁽⁴⁾	Case – Differential (std)
7	706894X	KIT – Outer Pinion Bearing	23	41221	Bolt – Drive Gear (qty 10)
8	36714	Slinger – Pinion Bearing Outer	24	42570	Snap Ring
9	40554	Seal – Pinion Oil	25	32926	Pinion – Differential
10	2-1-2651X	Companion Flange Assy (inc 11)	26	40380	Gear – Differential
11	232001	Slinger – Companion Flange	27	34096	Thrustwasher – Differential Pinion
12	30186	Washer – Pinion Nut	28	620875	Thrustwasher – Differential Gear
13	30185	Pinion Nut	29	41648	Shaft – Differential
	707224X	KIT – Carrier Cover (inc 14, 17)	30	13449	Lock – Differential Shaft
14	43008	Carrier Cover	31	45916	Oil Seal
			32	565987	Bearing Assembly
			33	— ⁽¹⁾	Shaft & Joint Assembly

(1) See "Bill of Material Table" below

(3) Contact Vehicle Manufacturer

(4) Not Sold Separately

Bill of Material Table

Axle			Axle Kits				Shaft & Joint Assy.	
Bill of Material	Diff. Type	Ratio	Ring Gear & Pinion Kit ⁽⁷⁾	Differential			Right Hand Shaft Assy.	Left Hand Shaft Assy.
				Case Assy. Kit ⁽⁸⁾	Case Kit	Inner Parts Kit		
1990-92 Aerostar								
610303-1	Standard	3.73	707221-1X	706974X	706975X	706890X	43159	43157
610303-2	Standard	3.27	707221-2X	706974X	706975X	706890X	43159	43157
1992 1/2 Aerostar								
610369-1	Standard	3.73	707221-1X	706974X	706975X	706890X	44102	44100
610369-2	Standard	3.27	707221-2X	706974X	706975X	706890X	44102	44100
1992 1/2-97 Aerostar								
610448-1	Standard	3.73	707221-1X	706974X	706975X	706890X	44102	44100
610448-2	Standard	3.27	707221-2X	706974X	706975X	706890X	44102	44100

(7) See Ring Gear & Pinion Kits in XGI Catalog for ratio & tooth combinations.

(8) See Differential Case Assy Kits in XGI Catalog for spline data & ratios.

Ford 1995-1998 1/2

**Model 35 /194 Front Axles
with CV Joints for**

**Explorer
Ranger**

Ford Model 35 /194 Front Axles w/CV Joints Exploded View

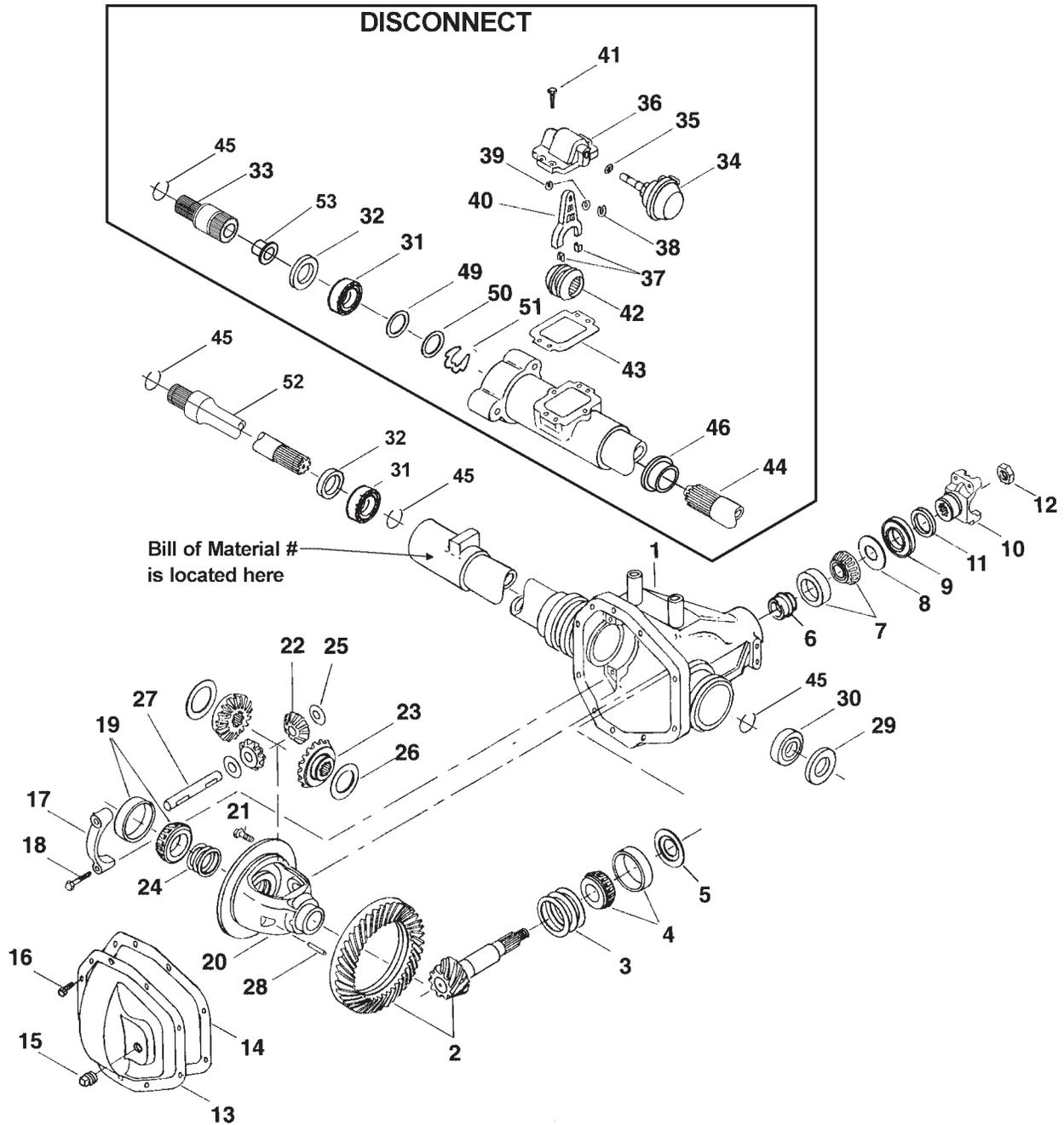

Ford Model 35 /194 Front Axles w/CV Joints Parts Listing



ITEM NO.	PART NUMBER	DESCRIPTION	ITEM NO.	PART NUMBER	DESCRIPTION
1	— ⁽³⁾	Housing – Axle Service	29	46065	Oil Seal
2	— ⁽¹⁾	Drive Pinion & Gear Assembly	30	566121	Bearing
3	701130X	PKG – Pinion Bearing Shim	31	566063	Bearing
4	707162X	KIT – Inner Pinion Bearing	32	46066	Oil Seal
5	— ⁽²⁾	Baffle – Pinion Oil	33	75117X	Axle Shaft Assembly (disconnect)
6	42102	Collapsible Spacer		75118X	Cover & Motor Assembly (disconnect)
7	706894X	KIT – Outer Pinion Bearing			(inc items 34, 35, 36, 37, 38, 39, 40)
8	42778	Slinger – Outer Pinion Bearing	34	— ⁽⁴⁾	Motor Assembly
9	51501	Seal – Pinion Oil	35	— ⁽⁴⁾	O-Ring
10	2-4-6901-1X	End Yoke Assembly (inc 11)	36	— ⁽⁴⁾	Cover – Disconnect Housing
11	42779	Slinger – End Yoke	37	621059	Clip – Shift Fork
12	44189	Pinion Nut	38	— ⁽⁴⁾	Snap Ring
13	47446	Carrier Cover	39	620979	Snap Ring
14	38615	RTV Silicone Sealant	40	42585	Shift Fork
15	43180	Plug – Carrier Cover	41	46071	Bolt – Cover & Motor Assembly
16	40286-5	Bolt – Carrier Cover (qty 10)	42	42998	Clutch Collar (disconnect)
17	— ⁽⁴⁾	Cap – Differential Bearing	43	46220	Gasket (disconnect)
18	40284-1	Bolt – Differential Bearing	44	46068	Shaft – Output (disconnect)
19	706016X	KIT – Differential Bearing	45	46072	Snap Ring
20	— ⁽⁴⁾	Case – Differential	46	43342	Bushing (disconnect)
21	41221	Bolt – Drive Gear (qty 8)	N.I.	42499-2	Bolt (disconnect)
22	46504	Pinion – Differential	N.I.	46077	Protection Shield (disconnect)
23	46502	Gear – Differential	49	46075	Thrustwasher (disconnect)
24	701004X	PKG – Differential Bearing Shim	50	46076	Thrustwasher (disconnect)
25	34096	Thrustwasher – Differential Pinion	51	46073	Snap Ring (disconnect)
26	— ⁽²⁾	Thrustwasher – Differential Gear	52	80297	Shaft Assembly (non-disconnect)
27	41648	Shaft – Differential	53	43337	Bushing (disconnect)
28	13449	Lock – Differential Shaft			

N.I. = Not Illustrated

- (1) See "Bill of Material Table" on next page
- (2) See "Variable Parts Table" below
- (3) Contact Vehicle Manufacturer
- (4) Not Sold Separately

Variable Parts Listing

Kits & Parts - Use With All Applications						
Description & Item Number (Refer to "Exploded View" on the previous page)			Bills of Material			
			610476	610556 610581 610582 610585	610586	610642 610643 610644 610645
1	Baffle – Pinion Oil	5	—	43599	—	43599
2	Thrustwasher – Differential Gear	26	40027	34095	34095	34095

Ford Model 35 /194 Front Axles w/CV Joints

Bill of Material Table

Axle			Axle Kits				Shaft & Joint Assy.	
Bill of Material	Diff. Type	Ratio	Ring Gear & Pinion Kit ⁽⁷⁾	Differential			Right Hand Shaft Assy.	Left Hand Shaft Assy.
				Case Assy. Kit ⁽⁸⁾	Case Kit	Inner Parts Kit		
1995 Explorer - Disconnect- CV								
610476-1	Standard	3.27	707359-1X	707342X	707360X	707343X	— ⁽³⁾	— ⁽³⁾
610476-2	Standard	3.55	707359-2X	707342X	707360X	707343X	— ⁽³⁾	— ⁽³⁾
610476-3	Standard	3.73	707359-3X	707342X	707360X	707343X	— ⁽³⁾	— ⁽³⁾
610476-4	Standard	4.10	707359-4X	707342X	707360X	707343X	— ⁽³⁾	— ⁽³⁾
1995-96 Explorer - Disconnect- CV								
610581-1	Standard	3.27	707359-1X	707378X	707360X	707379X	— ⁽³⁾	— ⁽³⁾
610581-2	Standard	3.55	707359-2X	707378X	707360X	707379X	— ⁽³⁾	— ⁽³⁾
610581-3	Standard	3.73	707359-3X	707378X	707360X	707379X	— ⁽³⁾	— ⁽³⁾
610581-4	Standard	4.10	707359-4X	707378X	707360X	707379X	— ⁽³⁾	— ⁽³⁾
610582-1	Standard	3.27	707359-1X	707378X	707360X	707379X	— ⁽³⁾	— ⁽³⁾
610582-2	Standard	3.55	707359-2X	707378X	707360X	707379X	— ⁽³⁾	— ⁽³⁾
610582-3	Standard	3.73	707359-3X	707378X	707360X	707379X	— ⁽³⁾	— ⁽³⁾
610582-4	Standard	4.10	707359-4X	707378X	707360X	707379X	— ⁽³⁾	— ⁽³⁾
1996 Explorer - Non-Disconnect - CV								
610585-1	Standard	3.73	707359-3X	707378X	707360X	707379X	— ⁽³⁾	— ⁽³⁾
610586-1	Standard	3.73	707359-3X	707378X	707360X	707379X	— ⁽³⁾	— ⁽³⁾
1997 1/2 Explorer - Non-Disconnect - CV								
610644-1	Standard	3.27	707359-1X	707378X	707360X	707379X	— ⁽³⁾	— ⁽³⁾
610644-2	Standard	3.55	707359-2X	707378X	707360X	707379X	— ⁽³⁾	— ⁽³⁾
610644-3	Standard	3.73	707359-3X	707378X	707360X	707379X	— ⁽³⁾	— ⁽³⁾
610644-4	Standard	4.10	707359-4X	707378X	707360X	707379X	— ⁽³⁾	— ⁽³⁾
1998 Explorer - Non-Disconnect - CV								
610556-1	Standard	3.27	707359-1X	707378X	707360X	707379X	— ⁽³⁾	— ⁽³⁾
610556-3	Standard	3.73	707359-3X	707378X	707360X	707379X	— ⁽³⁾	— ⁽³⁾
610556-4	Standard	4.10	707359-4X	707378X	707360X	707379X	— ⁽³⁾	— ⁽³⁾
610556-5	Standard	4.56	707359-5X	707378X	707360X	707379X	— ⁽³⁾	— ⁽³⁾
1998-98 1/2 Explorer/Ranger - Non-Disconnect - CV								
610642-1	Standard	3.27	707359-1X	707378X	707360X	707379X	— ⁽³⁾	— ⁽³⁾
610642-2	Standard	3.55	707359-2X	707378X	707360X	707379X	— ⁽³⁾	— ⁽³⁾
610642-3	Standard	3.73	707359-3X	707378X	707360X	707379X	— ⁽³⁾	— ⁽³⁾
610642-4	Standard	4.10	707359-4X	707378X	707360X	707379X	— ⁽³⁾	— ⁽³⁾
1998-98 1/2 Explorer - Non-Disconnect- CV								
610643-1	Standard	3.27	707359-1X	707378X	707360X	707379X	— ⁽³⁾	— ⁽³⁾
610643-3	Standard	3.73	707359-3X	707378X	707360X	707379X	— ⁽³⁾	— ⁽³⁾
610643-4	Standard	4.10	707359-4X	707378X	707360X	707379X	— ⁽³⁾	— ⁽³⁾
610643-5	Standard	4.56	707359-5X	707378X	707360X	707379X	— ⁽³⁾	— ⁽³⁾
610645-1	Standard	3.27	707359-1X	707378X	707360X	707379X	— ⁽³⁾	— ⁽³⁾
610645-2	Standard	3.55	707359-2X	707378X	707360X	707379X	— ⁽³⁾	— ⁽³⁾
610645-3	Standard	3.73	707359-3X	707378X	707360X	707379X	— ⁽³⁾	— ⁽³⁾
610645-4	Standard	4.10	707359-4X	707378X	707360X	707379X	— ⁽³⁾	— ⁽³⁾

(3) Contact Vehicle Manufacturer
 (7) See Ring Gear & Pinion Kits in XGI Catalog for ratio & tooth combinations.
 (8) See Differential Case Assy Kits in XGI Catalog for spline data & ratios.

Ford 1979

Model 44 /216 Front Axles for

F-150, F-250

Ford Model 44 /216 Front Axles Exploded View

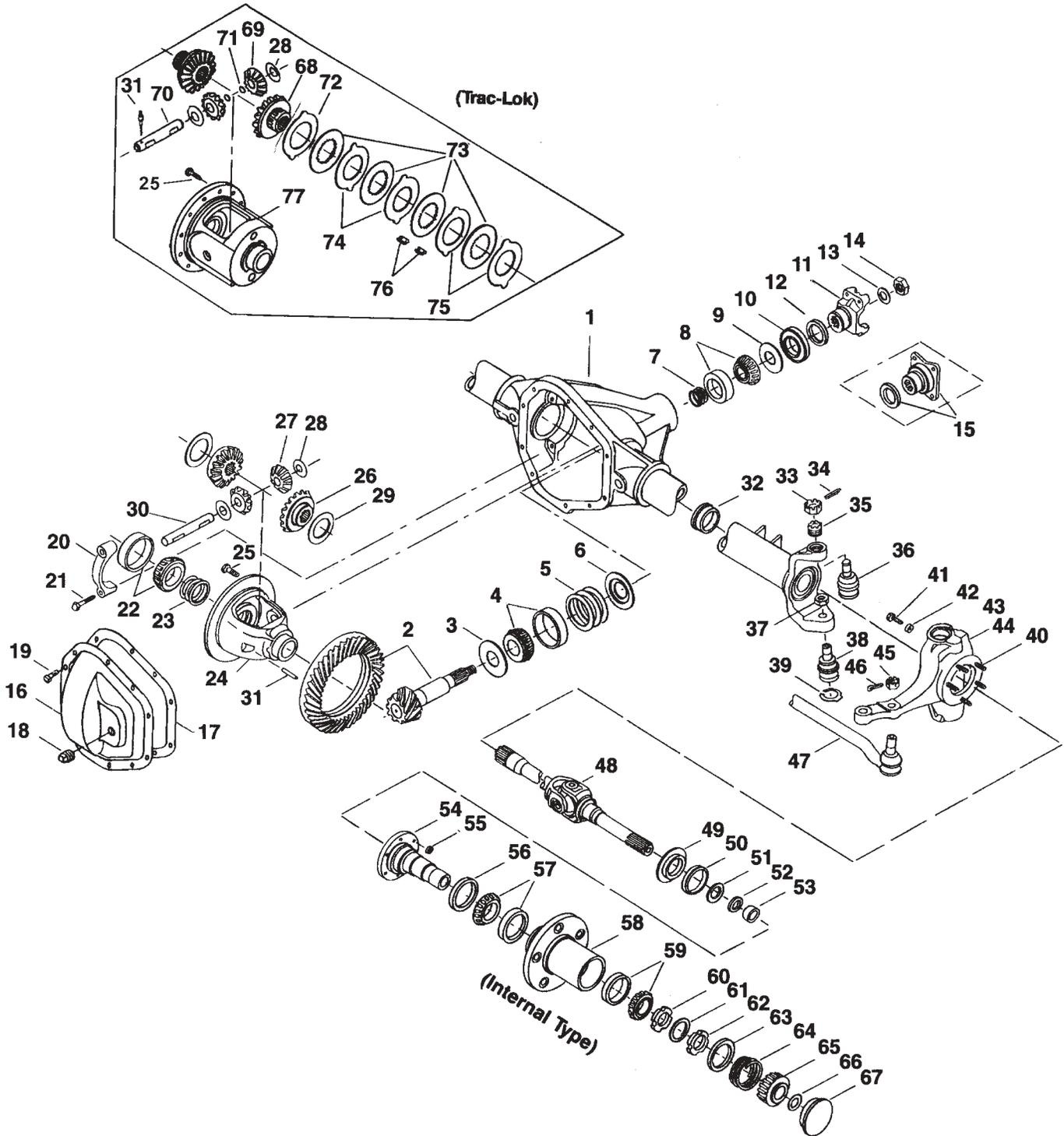

Ford Model 44 /216 Front Axles

Parts Listing

ITEM NO.	PART NUMBER	DESCRIPTION	ITEM NO.	PART NUMBER	DESCRIPTION
1	— ⁽³⁾	Housing – Axle Service	36	40112	Socket Assembly – Upper
2	— ⁽¹⁾	Drive Gear & Pinion Assembly	37	35566	Lock Nut
3	30764	Slinger – Pinion Bearing Inner	38	40113	Socket Assembly – Lower
4	706031X	KIT – Inner Pinion Bearing	39	35928	Snap Ring
	706376X	PKG – Diff & Pinion Bearing Shim (inc items 5, 7, 12, 13, 16, 22)	40	37759-2	Bolt – Hex (qty 5)
	706358X	PKG – Pinion Bearing Shim (inc items 5, 7, 12, 13, 16)	41	31026-1	Stop Screw
			42	500381-3	Jam Nut
5	— ⁽⁴⁾	Inner Pinion Bearing Shims (see shim packages)	43	— ⁽²⁾	Right Knuckle
			44	— ⁽²⁾	Left Knuckle
6	30765	Baffle – Pinion Bearing	45	— ⁽³⁾	Nut – Hex Slotted
7	— ⁽⁴⁾	Outer Pinion Bearing Shims (see shim packages)	46	— ⁽³⁾	Cotter Pin
			47	— ⁽³⁾	Tie Rod Assembly
8	706030X	KIT – Outer Pinion Bearing	48	— ⁽¹⁾	Shaft & Joint Assembly
9	13575	Slinger – Outer Pinion Bearing	49	36364	Slinger – Spindle Yoke
10	39118	Seal – Pinion Oil		706527X	KIT – Spindle Seal & Bearing (inc items 50, 51, 52, 53)
11	2-4-3581X	End Yoke or Assembly (inc 12)		— ⁽²⁾	KIT – Spindle
12	41498	Slinger – End Yoke	50	38128	Oil Seal
13	30186	Washer – Pinion Nut	51	36361	Oil Seal (block vee)
14	30185	Pinion Nut	52	38106	Spacer – Wheel Bearing Spindle
15	— ⁽³⁾	Companion Flange Assembly	53	550759	Needle Bearing Assembly
	706115X	KIT – Carrier Cover (inc items 16, 17, 18, 19)	54	— ⁽²⁾	Spindle – Wheel Bearing
			55	— ⁽³⁾	Nut – Brake Mounting
16	620195	Carrier Cover	56	36366	Oil Seal
17	34685	Gasket – Carrier Cover	57	— ⁽²⁾	KIT – Inner Wheel Bearing
18	36472	Plug – Carrier Cover	58	— ⁽³⁾	Wheel Hub
19	34279	Bolt – Carrier Cover	59	706111X	KIT – Outer Wheel Bearing
20	— ⁽³⁾	Differential Bearing Cap	60	21588X	Nut & Pin Assembly – Inner Lock
21	48632-1	Bolt – Differential Bearing Cap	61	36569	Lock Nut
22	706032X	KIT – Differential Bearing	62	31139	Nut – Wheel Bearing Adjusting
23	706086X	KIT – Diff Bearing Shim (inc 16)	63	32589	Plate – Spring Retaining
24	— ⁽⁴⁾	Case – Differential (std)	64	35218	Spring – Pressure
25	41221	Bolt – Drive Gear (qty 10)	65	31125	Gear – Axle Drive
26	31487	Gear – Differential (std)	66	620147	Snap Ring
27	17717	Pinion – Differential (std)	67	36858	Hub Cap
28	13338-3	Thrustwasher – Diff Pinion (std)	68	35657	Gear – Differential (t/l)
29	32121	Thrustwasher – Diff Gear (std)	69	32808	Pinion – Differential (t/l)
30	17878	Shaft – Differential (std)	70	39194	Shaft – Differential (t/l)
31	13449	Lock – Differential Shaft	71	42570	Snap Ring
32	— ⁽²⁾	Seal & Guide Tube		706352X	KIT – Differential Plate & Disc (t/l) (inc items 72, 73, 74, 75, 76)
	— ⁽²⁾	KIT – Right Knuckle Assy (inc 32, 33, 34, 35, 36, 37, 38, 39, 42)	72	— ⁽⁴⁾	Plate – Preload Spacer
	— ⁽²⁾	KIT – Left Knuckle Assy (inc items 35, 37, 38, 39, 43)	73	— ⁽⁴⁾	Disc – Differential
			74	— ⁽⁴⁾	Plate – Differential
	706116X	KIT – Socket Assembly (inc 32, 33, 34, 35, 36, 37, 38)	75	— ⁽⁴⁾	Plate – Differential Pressure
			76	40835	Clip – Diff Clutch Retainer
33	44101	Nut – Hex Slotted	77	— ⁽⁴⁾	Case – Differential (t/l)
34	500024-8	Cotter Pin	N.I.	— ⁽³⁾	Hub Lock
35	35417	Adjusting Split Ring			

N.I. = Not Illustrated

(1) See "Bill of Material Table" on next page

(2) See "Variable Parts Table" within this section

(3) Contact Vehicle Manufacturer

(4) Not Sold Separately

(5) See Camber/Casting Bushing Table at the back of the Ford section of this catalog

Ford Model 44 /216 Front Axles

Bill of Material Table

Axle			Axle Kits				Shaft & Joint Assy.	
Bill of Material	Diff. Type	Ratio	Ring Gear & Pinion Kit ⁽⁷⁾	Differential			Right Hand Shaft Assy.	Left Hand Shaft Assy.
				Case Assy. Kit ⁽⁸⁾	Case Kit	Inner Parts Kit		
1979 F-150 1/2 Ton Pick-Up (Full Time Transfer Case)								
610066-1	Standard	3.00	707240-2X	706020X	706024X	706027X	660124-1	660124-2
610066-2	Standard	3.50	707240-5X	706020X	706024X	706027X	660124-1	660124-2
610066-3	Standard	4.09	707240-9X	706021X	706025X	706027X	660124-1	660124-2
610066-4	Standard	4.09	707240-9X	706021X	706025X	706027X	660124-1	660124-2
610066-5	Standard	3.50	707240-5X	706020X	706024X	706027X	660124-1	660124-2
610066-6	Standard	3.00	707240-2X	706020X	706024X	706027X	660124-1	660124-2
610066-7	Trac Lok	3.50	707240-5X	707115X	707116X	707026X	660124-1	660124-2
1979 F-150 1/2 Ton Pick-Up (Part-Time Transfer Case)								
610067-1	Standard	3.00	707240-2X	706020X	706024X	706027X	660124-1	660124-2
610067-2	Standard	3.50	707240-5X	706020X	706024X	706027X	660124-1	660124-2
610067-3	Standard	4.09	707240-9X	706021X	706025X	706027X	660124-1	660124-2
610067-4	Trac Lok	3.50	707240-5X	707115X	707116X	706026X	660124-1	660124-2
610067-5	Trac Lok	3.50	707240-5X	707115X	707116X	706026X	660106-1	660106-2
610067-6	Trac Lok	4.09	707240-9X	707150X	707151X	706026X	660124-1	660124-2
1979 F-150 Super Cab								
610068-1	Standard	3.50	707240-5X	706020X	706024X	706027X	660124-3	660124-4
610068-2	Standard	3.50	707240-5X	706020X	706024X	706027X	660124-3	660124-4
610068-3	Standard	4.09	707240-9X	706021X	706025X	706027X	660124-3	660124-4
610068-4	Standard	4.09	707240-9X	706021X	706025X	706027X	660124-3	660124-4
610068-5	Trac Lok	3.50	707240-5X	707115X	707116X	706026X	660124-3	660124-4
1979 F-250								
610069-1	Standard	3.54	707240-6X	706020X	706024X	706027X	660124-3	660124-4
610069-2	Standard	3.54	707240-6X	706020X	706024X	706027X	660124-3	660124-4
610069-3	Standard	4.09	707240-9X	706021X	706025X	706027X	660124-3	660124-4
610069-4	Standard	4.09	707240-9X	706021X	706025X	706027X	660124-3	660124-4
610069-5	Standard	3.54	707240-6X	706020X	706024X	706027X	660124-3	660124-4
610069-6	Standard	3.54	707240-6X	706020X	706024X	706027X	660124-3	660124-4
610069-7	Standard	4.09	707240-9X	706021X	706025X	706027X	660124-3	660124-4
610069-8	Standard	4.09	707240-9X	706021X	706025X	706027X	660124-3	660124-4
610069-9	Standard	4.09	707240-9X	706021X	706025X	706027X	660106-3	660106-4
610069-10	Trac Lok	3.54	707240-6X	707115X	707116X	706026X	660124-3	660124-4
610069-11	Trac Lok	4.09	707240-9X	707150X	707151X	706026X	660124-3	660124-4
610069-12	Standard	3.54	707240-6X	706020X	706024X	706027X	660106-3	660106-4

(7) See Ring Gear & Pinion Kits in XGI Catalog for ratio & tooth combinations.

(8) See Differential Case Assy Kits in XGI Catalog for spline data & ratios.

Variable Parts Listing

Kits & Parts - Use With All Applications							
Description & Item Number (Refer to "Exploded View" at the front of this section)				Bills of Material			
				610066 610067	610068	610069	
1	Seal & Guide Tube	32	620257-2	620216	620216		
2	KIT – Right Knuckle Assembly	-	700035	700001	700010		
3	KIT – Left Knuckle Assembly	-	660108	660025	660032		
4	Right Knuckle	43	620161	620037	620045		
5	Left Knuckle	44	620162	620038	620046		
6	KIT – Spindle	-	706552X	706552X	700004		
7	Spindle – Wheel Bearing	54	38421	38421	620006		
8	KIT – Inner Wheel Bearing	57	706110X	706110X	706074X		

Ford 1998 1/2

Model 50 /229 Front Axles for

F-250, F-350

Ford Model 50 /229 Front Axles Exploded View

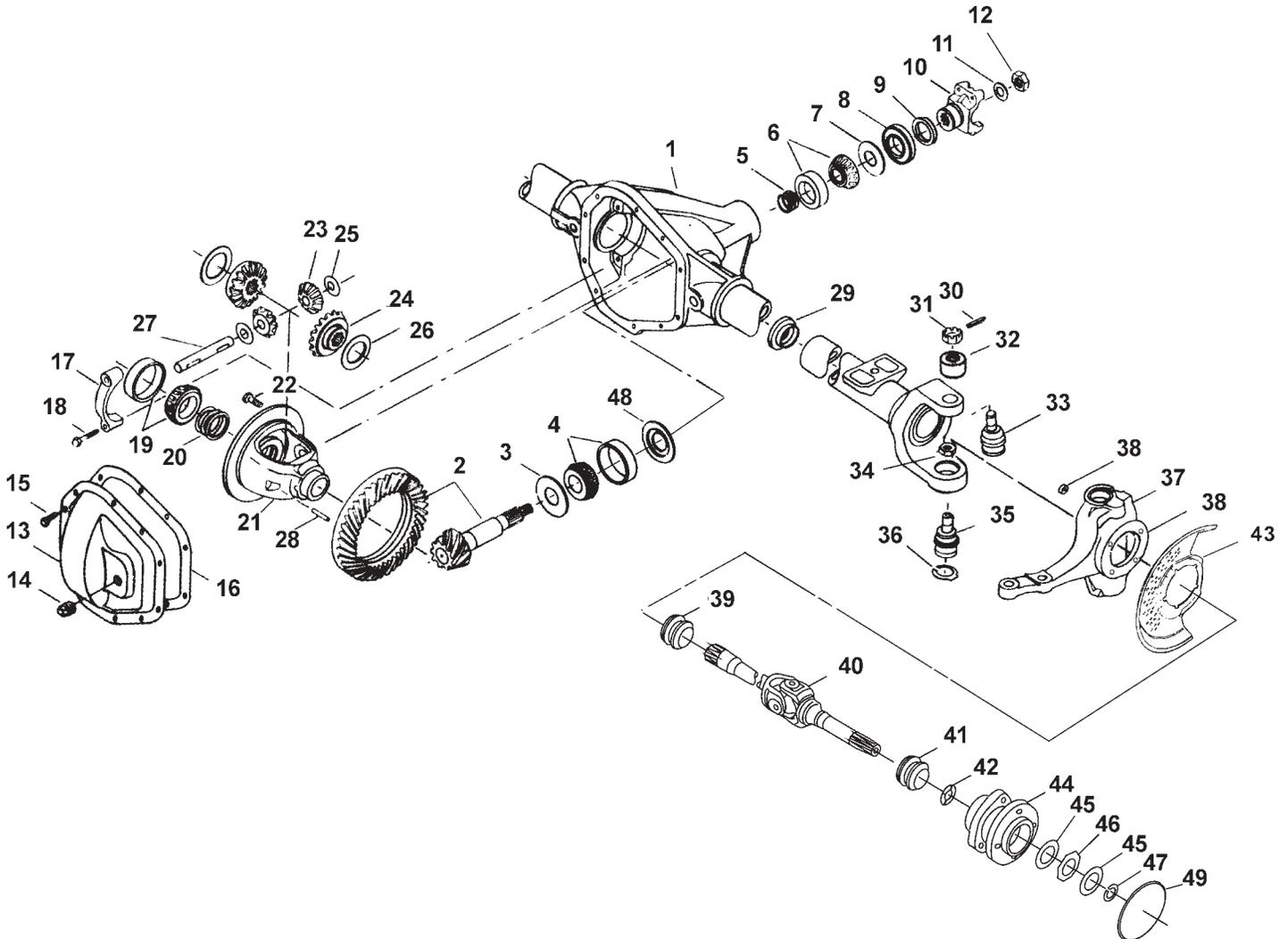

Ford Model 50 /229 Front Axles Parts Listing

ITEM NO.	PART NUMBER	DESCRIPTION	ITEM NO.	PART NUMBER	DESCRIPTION
1	— ⁽³⁾	Housing – Axle Service	27	620414	Shaft – Differential
2	— ⁽¹⁾	Drive Pinion & Gear Assembly	28	44810	Lock – Differential Shaft
3	701112X	PKG – Inner Pinion Bearing Shim	29	48773	Oil Seal
	701160X	PKG – Diff & Pinion Bearing Shim		700238-2X	KIT – Socket Assembly (inc items 30, 31, 33, 34, 35, 36)
4	706015X	KIT – Inner Pinion Bearing			
5	44896	Collapsible Spacer	30	500024-8	Cotter Pin
6	706030X	KIT – Outer Pinion Bearing	31	44101	Nut – Hex Slotted
7	13575	Slinger – Outer Pinion Bearing	32	44507	Bushing
8	47761	Seal – Pinion Oil	33	47184	Upper Socket Assy
9	47762	Seal – End Yoke	34	44133	Lock Nut
10	3-4-13761-1	End Yoke Assembly	35	47185	Lower Socket Assy
11	30186	Washer – Pinion Nut	36	620343	Snap Ring
12	30185	Pinion Nut	37	— ⁽³⁾	Knuckle
13	47707-1	Carrier Cover	38	48660	Nut – Knuckle
14	43180	Plug – Carrier Cover	39	50381	Oil Seal
15	47508	Bolt – Carrier Cover (qty 9)	40	— ⁽¹⁾	Shaft & Joint Assembly
16	38615	RTV Silicone Sealant	41	50491	Oil Seal
17	— ⁽³⁾	Differential Bearing Cap	42	47766	Thrustwasher
18	48632-1	Bolt – Differential Bearing Cap	43	47758	Dust Shield
19	700097	KIT – Differential Bearing	44	— ⁽³⁾	Hub Assembly
20	701006X	PKG – Differential Bearing Shim		701166X	PKG – Thrustwasher (inc 45, 46)
21	— ⁽¹⁾	Case – Differential	45	47760	Thrustwasher
22	45784	Bolt – Drive Gear (qty 10)	46	47759	Thrustwasher
23	620436	Pinion – Differential	47	620142	Snap Ring
24	40432	Gear – Differential	48	47742	Baffle – Pinion Bearing
25	620439	Thrustwasher – Differential Pinion	49	41784-2	O-Ring
26	50718	Thrustwasher – Differential Gear			

(1) See "Bill of Material Table" below

(3) Contact Vehicle Manufacturer

Bill of Material Table

Axle			Axle Kits				Shaft & Joint Assy.	
Bill of Material	Diff. Type	Ratio	Ring Gear & Pinion Kit ⁽⁷⁾	Differential			Right Hand Shaft Assy.	Left Hand Shaft Assy.
				Case Assy. Kit ⁽⁸⁾	Case Kit	Inner Parts Kit		
1998 1/2-99 F-250/350 SRW (4x4) ABS								
610654-1	Standard	3.73	76127-5X ⁽⁹⁾	707459X	706917X	706916X	76110-1X	76110-2X
610654-2	Standard	4.10	660319-5 ⁽⁹⁾	707459X	706917X	706916X	76110-1X	76110-2X
610654-3	Standard	4.30	76136-5X ⁽⁹⁾	707459X	706917X	706916X	76110-1X	76110-2X
1998 1/2-99 F-250/350 SRW (4x4)								
610659-1	Standard	3.73	76127-5X ⁽⁹⁾	707459X	706917X	706916X	76110-1X	76110-2X
610659-2	Standard	4.10	660319-5 ⁽⁹⁾	707459X	706917X	706916X	76110-1X	76110-2X
610659-3	Standard	4.30	76136-5X ⁽⁹⁾	707459X	706917X	706916X	76110-1X	76110-2X

(7) See Ring Gear & Pinion Kits in XGI Catalog for ratio & tooth combinations.

(8) See Differential Case Assy Kits in XGI Catalog for spline data & ratios.

(9) Gear set includes ring, pinion and drive gear screws.

Ford 1978-1998

Model 60 /248 Front Axles for

F-250, F-350

Ford Model 60 /248 Front Axles Exploded View

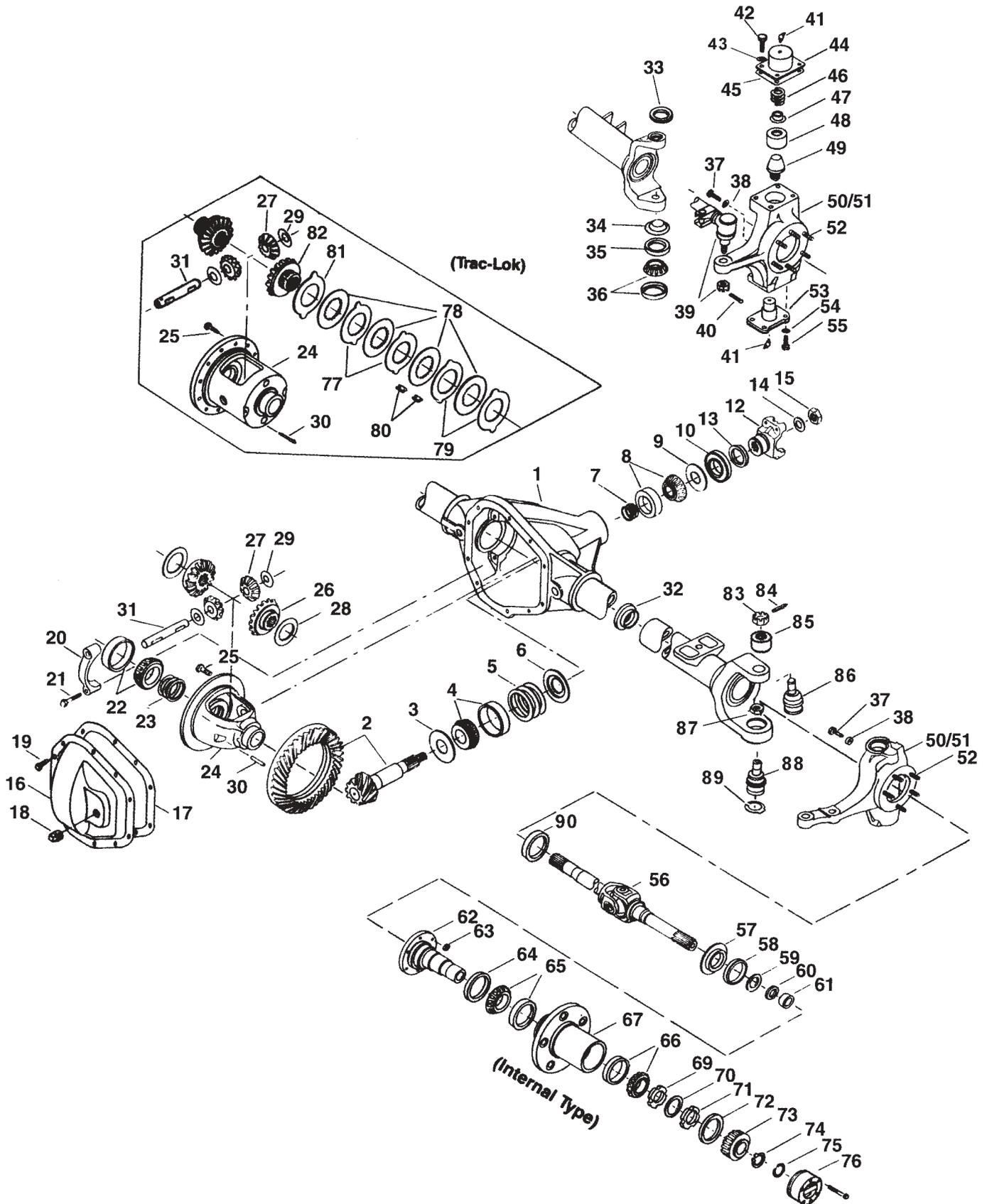

Ford Model 60 /248 Front Axles

Parts Listing

ITEM NO.	PART NUMBER	DESCRIPTION	ITEM NO.	PART NUMBER	DESCRIPTION
1	— ⁽³⁾	Housing – Axle Service	47	620180	Spring Retainer
2	— ⁽¹⁾	Drive Pinion & Gear Assembly	48	41886	Bushing – King Pin
3	34643	Slinger – Inner Pinion	49	37302	King Pin
4	706046X	KIT – Inner Pinion Bearing	50	— ⁽³⁾	Right Knuckle
5	—	Inner Pinion Bearing Shims	51	— ⁽³⁾	Left Knuckle
	706375X	PKG – Diff & Pinion Bearing Shim (inc items 5, 7, 14, 15, 17, 23)	52	— ⁽²⁾	Bolt – Hex
			53	37299	King Pin Bearing Cap – Lower
6	30982	Baffle – Pinion Bearing	54	500357-13	Lockwasher (King Pin Cap – Lower)
	706359X	PKG – Pinion Bearing Shim (inc items 5, 7, 14, 15, 17)	55	500412-13	Bolt – Hex (King Pin Cap – Lower)
			56	— ⁽¹⁾	Shaft & Joint Assembly
7	—	Outer Pinion Bearing Shims (see shim packages)	57	— ⁽²⁾	Slinger – Spindle Yoke
				— ⁽²⁾	KIT – Spindle Seal & Bearing (inc items 58, 59, 60, 61)
8	706045X	KIT – Outer Pinion Bearing		— ⁽²⁾	KIT – Spindle (inc 58, 59, 60, 61, 62)
9	42737	Thrustwasher – Bearing		— ⁽²⁾	Oil Seal
10	— ⁽²⁾	Pinion Seal	58	— ⁽²⁾	Spacer – Wheel Bearing Spindle
11	— ⁽²⁾	PKG – End Yoke Seal (inc 10, 13)	59	— ⁽²⁾	Oil Seal (block-vee)
12	— ⁽²⁾	End Yoke or Assembly (inc 13)	60	— ⁽²⁾	Needle Bearing Assembly
13	— ⁽²⁾	Slinger – End Yoke	61	620063	Spindle – Wheel Bearing
14	30275	Washer – Pinion Nut	62	620086	Nut – Brake Mounting
15	30271	Pinion Nut	63	36805	Oil Seal
	— ⁽²⁾	KIT – Carrier Cover (inc 16, 18, 19)	64	48816	KIT – Inner Wheel Bearing
16	— ⁽²⁾	Carrier Cover	65	706411X	KIT – Outer Wheel Bearing
17	34687	Gasket – Carrier Cover	66	706074X	Wheel Hub
18	— ⁽²⁾	Plug – Carrier Cover	67	— ⁽³⁾	Thrustwasher – Wheel Bearing
19	34822	Bolt – Carrier Cover (qty 10)	N.I.	— ⁽²⁾	Spindle Nut or Nut & Pin Assembly
20	— ⁽³⁾	Differential Bearing Cap	69	— ⁽²⁾	Lockwasher – Wheel Bearing Nut
21	48632-1	Bolt – Differential Bearing Cap	70	— ⁽²⁾	Spindle Nut
22	706047X	KIT – Differential Bearing	71	— ⁽²⁾	Spacer
23	706378X	PKG – Diff Bearing Shim (inc 17)	72	— ⁽²⁾	Gear – Axle Drive
24	— ⁽⁴⁾	Case – Differential	73	— ⁽²⁾	Thrustwasher Package
25	— ⁽²⁾	Bolt – Drive Gear (qty 12)		— ⁽²⁾	Snap Ring
26	35625	Gear – Differential (std)	74	— ⁽²⁾	Snap Ring
27	34367	Pinion – Differential	75	— ⁽²⁾	Hub Cap
28	34729	Thrustwasher – Diff Gear (std)	76	— ⁽²⁾	Hub Lock Assembly
29	34730	Thrustwasher – Diff Pinion (std-t/l)		— ⁽³⁾	KIT – Differential Plate & Disc (t/l) (inc items 77, 78, 79, 80, 81)
30	44810	Lock – Differential Shaft		707083X	Plate – Differential Pressure
31	30263	Shaft – Differential			Disc – Differential
32	— ⁽²⁾	Seal & Guide Tube	77	— ⁽⁴⁾	Plate – Differential
	— ⁽²⁾	KIT – King Pin Parts (inc 33,34,35,36)	78	— ⁽⁴⁾	Clip – Differential Clutch
33	— ⁽²⁾	King Pin Seal – Upper	79	— ⁽⁴⁾	Spacer – Plate Preload
34	37305	Grease Retainer	80	40835	Gear – Differential (t/l)
35	41777	Oil Seal	81	— ⁽⁴⁾	KIT – Socket Assembly (inc items 83, 84, 86, 87, 88, 89)
36	706150X	KIT – King Pin Bearing – Lower	82	35830	Nut – Hex Slotted
37	— ⁽²⁾	Stop Screw		700238-2X	Cotter Pin
38	— ⁽²⁾	Jam Nut			Bushing – Socket Design (Alternate Bushing Selection)
39	— ⁽³⁾	Tie Rod Assembly	83	44101	Socket – Upper
40	— ⁽³⁾	Cotter Pin	84	500024-8	Lock Nut
41	500175-1	Lube Fitting	85	44507	Socket – Lower
42	30875	Nut – Hex Tapered		— ⁽⁵⁾	Snap Ring
43	— ⁽³⁾	Lockwasher (King Pin Cap – Upper)	86	47184	Seal – Outer Tube
44	620083	Steering Arm (LH only)	87	44133	
	620132	King Pin Cap – Upper (RH only)	88	47185	
45	37307	Gasket – King Pin Cap	89	620343	
46	37300	Spring – Pressure	90	— ⁽²⁾	

N.I. = Not Illustrated

(1) See "Bill of Material Table" on next page

(2) See "Variable Parts Table" within this section

(3) Contact Vehicle Manufacturer

(4) Not Sold Separately

(5) See Camber/Casting Bushing Table at the back of the Ford section of this catalog

Ford Model 60 /248 Front Axles

Bill of Material Table

Axle			Axle Kits				Shaft & Joint Assy.	
Bill of Material	Diff. Type	Ratio	Ring Gear & Pinion Kit ⁽⁷⁾	Differential			Right Hand Shaft Assy.	Left Hand Shaft Assy.
				Case Assy. Kit ⁽⁸⁾	Case Kit	Inner Parts Kit		
1978-79 F-250 & F-350 (Snow Fighter)								
610023-1	Standard	3.54	700020-1	706180X	706040X	706702X	660048-1	660048-2
610023-2	Standard	3.54	700020-1	706180X	706040X	706702X	660048-1	660048-2
610023-4	Trac Lok	3.54	700020-1	707090-4X	708014	707086X	660048-1	660048-2
610023-5	Standard	4.10	700020-2	706180X	706040X	706702X	660048-1	660048-2
610023-6	Standard	4.10	700020-2	706180X	706040X	706702X	660048-1	660048-2
610023-8	Trac Lok	4.10	700020-2	707090-4X	708014	707086X	660048-1	660048-2
610023-9	Standard	4.10	700020-2	706180X	706040X	706702X	660048-1	660048-2
610023-10	Standard	3.54	700020-1	706180X	706040X	706702X	660048-1	660048-2
610023-11	Standard	3.54	700020-1	706180X	706040X	706702X	660048-1	660048-2
610023-12	Standard	4.10	700020-2	706180X	706040X	706702X	660048-1	660048-2
610023-13	Standard	4.10	700020-2	706180X	706040X	706702X	660048-1	660048-2
1985 F-350								
610220-2	Standard	3.54	700020-1	706180X	706040X	706702X	660048-4	660048-5
610220-4	Standard	4.10	700020-2	706180X	706040X	706702X	660048-4	660048-5
610220-8	Standard	4.10	700020-2	706180X	706040X	706702X	660048-4	660048-5
1986-88 F-350 Monobeam DRW								
610255-1	Standard	3.54	700020-1	706180X	706040X	706702X	660048-4	660048-5
610255-2	Standard	4.10	700020-2	706180X	706040X	706702X	660048-4	660048-5
610255-3	Standard	4.10	700020-2	706180X	706040X	706702X	660048-4	660048-5
1988 F-350 Monobeam SRW								
610305-1	Standard	3.54	700020-1	706180X	706040X	706702X	660048-4	660048-5
610305-2	Standard	4.10	700020-2	706180X	706040X	706702X	660048-4	660048-5
1988 1/2-91 1/2 F-350 Monobeam SRW								
610313-1	Standard	3.54	700020-1	706180X	706040X	706702X	76659-2X	76659-1X
610313-2	Standard	4.10	700020-2	706180X	706040X	706702X	76659-2X	76659-1X
610313-3	Standard	4.10	700020-2	706180X	706040X	706702X	76659-2X	76659-1X
1992 F-350 (Uses Socket Assy Instead of King Pin Assy)								
610371-1	Standard	3.54	700020-1	706180X	706040X	706702X	76659-2X	76659-1X
610371-2	Standard	4.10	700020-2	706180X	706040X	706702X	76659-2X	76659-1X
610371-3	Standard	4.10	700020-2	706180X	706040X	706702X	76659-2X	76659-1X
610371-4	Standard	3.54	700020-1	706180X	706040X	706702X	76659-2X	76659-1X
610371-5	Standard	4.10	700020-2	706180X	706040X	706702X	76659-2X	76659-1X
610371-6	Standard	4.10	700020-2	706180X	706040X	706702X	76659-2X	76659-1X
1993-93 1/2 F-350								
610432-1	Standard	3.54	700020-1	706180X	706040X	706702X	76659-2X	76659-1X
610432-2	Standard	4.10	700020-2	706180X	706040X	706702X	76659-2X	76659-1X
610432-3	Standard	4.10	700020-2	706180X	706040X	706702X	76659-2X	76659-1X
610432-4	Standard	3.54	700020-1	706180X	706040X	706702X	76659-2X	76659-1X
610432-5	Standard	4.10	700020-2	706180X	706040X	706702X	76659-2X	76659-1X
610432-6	Standard	4.10	700020-2	706180X	706040X	706702X	76659-2X	76659-1X
1994 F-350								
610445-1	Standard	3.54	700020-1	706180X	706040X	706702X	76659-2X	76659-1X
610445-2	Standard	4.10	700020-2	706180X	706040X	706702X	76659-2X	76659-1X
610445-3	Standard	4.10	700020-2	706180X	706040X	706702X	76659-2X	76659-1X
610445-4	Standard	3.54	700020-1	706180X	706040X	706702X	76659-2X	76659-1X
610445-5	Standard	4.10	700020-2	706180X	706040X	706702X	76659-2X	76659-1X
610445-6	Standard	4.10	700020-2	706180X	706040X	706702X	76659-2X	76659-1X

(7) See Ring Gear & Pinion Kits in XGI Catalog for ratio & tooth combinations.

(8) See Differential Case Assy Kits in XGI Catalog for spline data & ratios.

Ford Model 60 /248 Front Axles Bill of Material Table

Axle			Axle Kits				Shaft & Joint Assy.	
Bill of Material	Diff. Type	Ratio	Ring Gear & Pinion Kit ⁽⁷⁾	Differential			Right Hand Shaft Assy.	Left Hand Shaft Assy.
				Case Assy. Kit ⁽⁸⁾	Case Kit	Inner Parts Kit		
1995 F-350								
610460-1	Standard	3.54	700020-1	706180X	706040X	706702X	76659-2X	76659-1X
610460-2	Standard	4.10	700020-2	706180X	706040X	706702X	76659-2X	76659-1X
610460-3	Standard	4.10	700020-2	706180X	706040X	706702X	76659-2X	76659-1X
610460-4	Standard	3.54	700020-1	706180X	706040X	706702X	76659-2X	76659-1X
610460-5	Standard	4.10	700020-2	706180X	706040X	706702X	76659-2X	76659-1X
610460-6	Standard	4.10	700020-2	706180X	706040X	706702X	76659-2X	76659-1X
610460-7	Standard	3.54	700020-1	706180X	706040X	706702X	76659-2X	76659-1X
610460-8	Standard	4.10	700020-2	706180X	706040X	706702X	76659-2X	76659-1X
610460-9	Standard	4.10	700020-2	706180X	706040X	706702X	76659-2X	76659-1X
610460-10	Standard	3.54	700020-1	706180X	706040X	706702X	76659-2X	76659-1X
610460-11	Standard	4.10	700020-2	706180X	706040X	706702X	76659-2X	76659-1X
610460-12	Standard	4.10	700020-2	706180X	706040X	706702X	76659-2X	76659-1X
1996 1/2-97 F-350								
610610-1	Standard	3.54	700020-1	707460X	706040X	706702X	76659-2X	76659-1X
610610-2	Standard	4.10	700020-2	707460X	706040X	706702X	76659-2X	76659-1X
610610-3	Standard	4.10	700020-2	707460X	706040X	706702X	76659-2X	76659-1X
610610-4	Standard	3.54	700020-1	707460X	706040X	706702X	76659-2X	76659-1X
610610-5	Standard	4.10	700020-2	707460X	706040X	706702X	76659-2X	76659-1X
610610-6	Standard	4.10	700020-2	707460X	706040X	706702X	76659-2X	76659-1X
1997 1/2-98 F-350								
610741-1	Standard	3.54	700020-1	707460X	706040X	706702X	76659-2X	76659-1X
610741-2	Standard	4.10	700020-1	707460X	706040X	706702X	76659-2X	76659-1X
610741-3	Standard	4.10	700020-2	707460X	706040X	706702X	76659-2X	76659-1X
610741-4	Standard	3.54	700020-1	707460X	706040X	706702X	76659-2X	76659-1X
610741-5	Standard	4.10	700020-2	707460X	706040X	706702X	76659-2X	76659-1X
610741-6	Standard	4.10	700020-2	707460X	706040X	706702X	76659-2X	76659-1X

(7) See Ring Gear & Pinion Kits in XGI Catalog for ratio & tooth combinations.

(8) See Differential Case Assy Kits in XGI Catalog for spline data & ratios.

Ford Model 60 /248 Front Axles Variable Parts Listing

Kits & Parts - Use With All Applications							
Description & Item Number (Refer to "Exploded View" at the front of this section)			Bills of Material				
			610023	610220	610255 610305	610313	610371
1	Pinion Seal	10	42449	42449	42449	42449	610371
2	PKG – End Yoke Seal (inc 10, 13)	11	—	—	—	—	—
3	End Yoke or Assembly (inc 13)	12	2-4-4291X	2-4-5311X	2-4-8051X	2-4-8051X	2-4-8051X
4	Slinger – End Yoke	13	34592	34592	41195	41195	41195
5	KIT – Carrier Cover	-	700041	707002X	707002X	707233X	707233X
6	Carrier Cover	16	620079	620079	620079	43600-1	43600-1
7	Plug – Carrier Cover	18	36472	36472	36472	43180	43180
8	Bolt – Drive Gear (qty 12)	25	30266	30266	30266	30266	30266
9	Seal & Guide Tube	32	36487	36487	36487	36487	36487
10	KIT – King Pin Parts	-	706395X	707042X	707042X	707042X	—
11	King Pin Seal – Upper	33	620058	41778	41778	41778	—
12	Stop Screw	37	620143-3	620143-3	620143-3	620143-3	620143-3
13	Jam Nut	38	500381-3	500381-3	500381-3	500381-3	500381-3
14	Bolt – Hex	52	37759-2	37759-2	37759-2	37759-2	37759-1
15	Slinger – Spindle Yoke	57	37308	37308	37308	37308	37308
16	KIT – Spindle Seal & Bearing	-	700014	700014	700014	700014	708084
17	KIT – Spindle	-	700022	700022	700022	700022	708085
18	Oil Seal	58	37311	37311	37311	37311	50381
19	Spacer – Wheel Bearing Spindle	59	37312	37312	37312	37312	—
20	Oil Seal (block-vee)	60	620062	620062	620062	620062	44506
21	Thrustwasher – Wheel Bearing	N.I.	33734	33734	—	—	—
22	Spindle Nut or Nut & Pin Assembly	69	33732	33732	660568	660568	660568
23	Lockwasher – Wheel Bearing Nut	70	33733	33733	621028	621028	621028
24	Spindle Nut	71	33732	33732	621027	621027	621027
25	Spacer	72	37997	37997	—	—	—
26	Gear – Axle Drive	73	37994	37994	—	—	—
27	Thrustwasher Package	-	—	—	—	—	—
28	Snap Ring	74	620142	620142	620142	620142	620142
29	Snap Ring	75	—	—	620097	620097	620097
30	Hub Cap	76	620194	620194	—	—	—
31	Seal – Outer Tube	90	—	—	—	50492	50492

Ford Model 60 /248 Front Axles Variable Parts Listing

Kits & Parts - Use With All Applications							
Description & Item Number (Refer to "Exploded View" at the front of this section)			Bills of Material				
			610432	610445	610460	610610	610741
1	Pinion Seal	10	42449	42449	42449	42449	—
2	PKG – End Yoke Seal (inc 10, 13)	11	—	—	—	—	701164X
3	End Yoke or Assembly (inc 13)	12	2-4-8051X	2-4-8051X	2-4-8051X	2-4-8051X	2-4-8251
4	Slinger – End Yoke	13	41195	41195	41195	41195	—
5	KIT – Carrier Cover	-	707233X	707233X	707233X	707233X	707233X
6	Carrier Cover	16	43600-1	43600-1	43600-1	43600-1	43600-1
7	Plug – Carrier Cover	18	43180	43180	43180	43180	43180
8	Bolt – Drive Gear (qty 12)	25	40638	40638	40638	40638	40638
9	Seal & Guide Tube	32	48773	48773	48773	48773	48773
10	KIT – King Pin Parts	-	—	—	—	—	—
11	King Pin Seal – Upper	33	—	—	—	—	—
12	Stop Screw	37	620143-3	620143-3	—	—	—
13	Jam Nut	38	500381-5	500381-5	—	—	—
14	Bolt – Hex	52	37759-1	37759-1	37759-1	37759-1	37759-1
15	Slinger – Spindle Yoke	57	—	—	—	—	—
16	KIT – Spindle Seal & Bearing	-	708084	708084	708084	708084	708084
17	KIT – Spindle	-	708085	708085	708085	708085	708085
18	Oil Seal	58	50381	50381	50381	50381	50381
19	Spacer – Wheel Bearing Spindle	59	—	—	—	—	—
20	Oil Seal (block-vee)	60	44506	44506	44506	44506	44506
21	Thrustwasher – Wheel Bearing	N.I.	—	—	—	—	—
22	Spindle Nut or Nut & Pin Assembly	69	660568	660568	660568	—	—
23	Lockwasher – Wheel Bearing Nut	70	621028	621028	621028	—	—
24	Spindle Nut	71	621027	621027	621027	—	—
25	Spacer	72	—	—	—	—	—
26	Gear – Axle Drive	73	—	—	—	—	—
27	Thrustwasher Package	-	—	—	—	—	701132X
28	Snap Ring	74	—	—	—	—	620142
29	Snap Ring	75	620097	620097	620097	620097	620097
30	Hub Cap	76	—	—	—	—	—
31	Seal – Outer Tube	90	50492	50492	—	50492	50492

Ford 1986-1989 1/2

Model 30 /181 Rear Axles for

Aerostar

Ford Model 30 /181 Rear Axles Exploded View

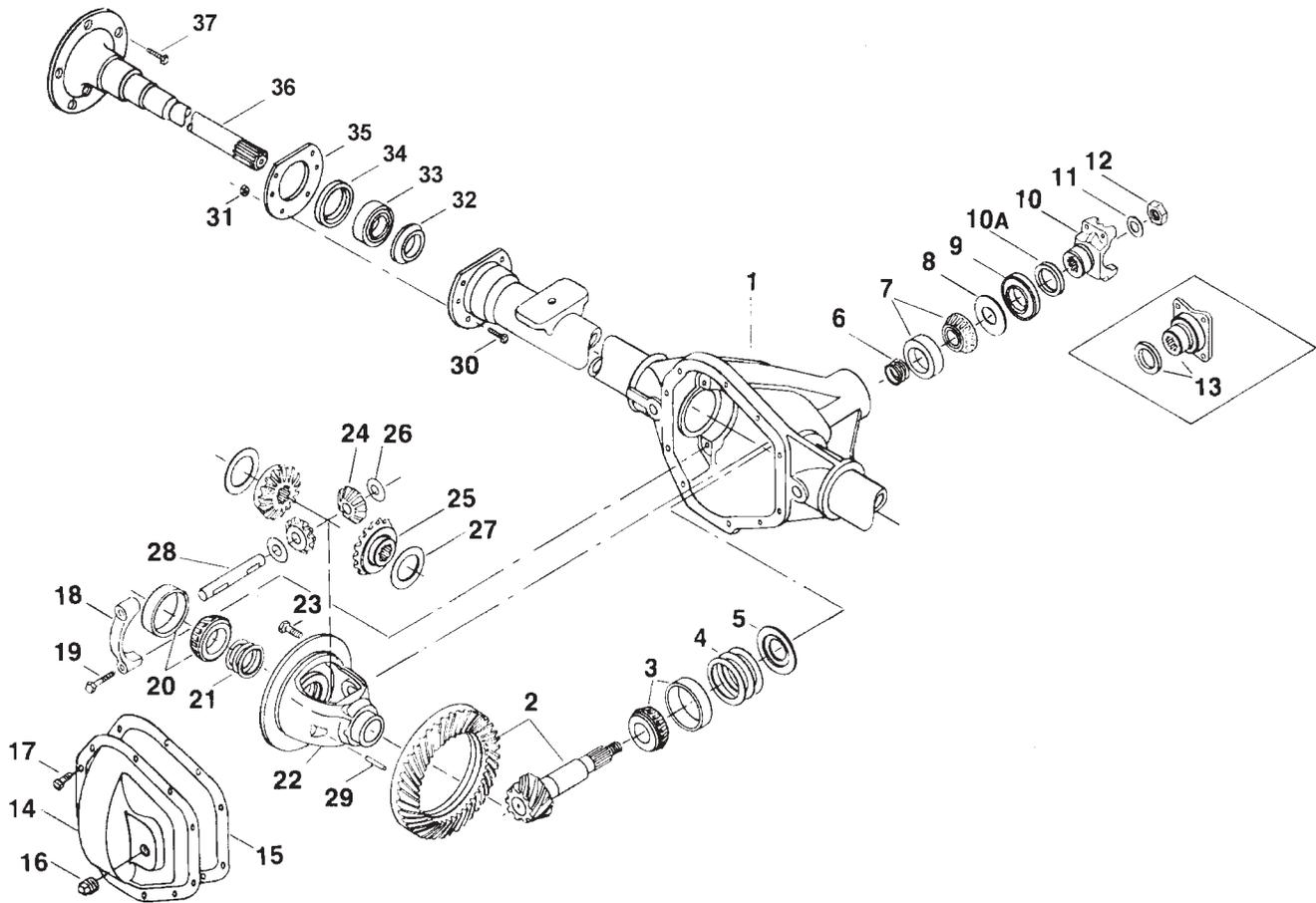

Ford Model 30 /181 Rear Axles Parts Listing

ITEM NO.	PART NUMBER	DESCRIPTION	ITEM NO.	PART NUMBER	DESCRIPTION
1	— ⁽³⁾	Housing – Axle Service	16	41356	Plug – Carrier Cover
2	— ⁽¹⁾	Drive Pinion & Gear Assembly	17	34279	Bolt – Carrier Cover (qty 10)
3	706015X	KIT – Inner Pinion Bearing	18	— ⁽³⁾	Differential Bearing Cap
4	—	Inner Pinion Bearing Shims (see shim packages)	19	40284-1	Bolt – Differential Bearing Cap
5	32349	Baffle – Pinion Bearing	20	706016X	KIT – Differential Bearing
	706386X	PKG – Diff & Pinion Bearing Shim (inc items 4, 6, 11, 12, 15, 21)	21	706086X	PKG – Diff Bearing Shim (inc 15)
6	—	Outer Pinion Bearing Shims (see shim packages)	22	— ⁽⁴⁾	Case – Differential
	706360X	PKG – Diff & Pinion Bearing Shim (inc items 4, 6, 11, 12, 15)	23	30187	Bolt – Drive Gear (qty 10)
7	706014X	KIT – Outer Pinion Bearing	24	32926	Pinion – Differential
8	41012	Slinger – Pinion Bearing Outer	25	33213	Gear – Differential
9	41455	Seal – Pinion Oil	26	34096	Thrustwasher – Diff Pinion
10	2-4-5251X	End Yoke Assembly (inc 10A)	27	34095	Thrustwasher – Diff Gear
10A	41498	Slinger – End Yoke	28	41648	Shaft – Differential
11	30186	Washer – Pinion Nut	29	13449	Lock – Differential Shaft
12	30185	Pinion Nut	30	34616-1	Bolt – Brake Mounting
13	— ⁽³⁾	Companion Flange Assembly	31	35704	Nut – Brake Mounting
	707076X	KIT – Carrier Cover (inc items 14, 16, 17)		706851X	KIT – Unit Bearing and Seal (inc items 32, 33, 34, 35)
14	41939	Carrier Cover	32	36121	Retainer Ring – Wheel Bearing
15	34684	Gasket – Carrier Cover	33	565909	Wheel Bearing Assembly
			34	35938	Seal – Outboard Shaft
			35	41647	Retainer – Oil Seal
			36	— ⁽¹⁾	Axle Shaft
			37	38638	Bolt – Axle Shaft

(1) See "Bill of Material Table" below

(3) Contact Vehicle Manufacturer

(4) Not Sold Separately

Bill of Material Table

Axle			Axle Kits				Shaft & Joint Assy.	
Bill of Material	Diff. Type	Ratio	Ring Gear & Pinion Kit ⁽⁷⁾	Differential			Right Hand Shaft Assy.	Left Hand Shaft Assy.
				Case Assy. Kit ⁽⁸⁾	Case Kit	Inner Parts Kit		
1986-88 1A Aerostar Van								
605273-1	Standard	3.73	706000-20X	72720X	706008X	707041X	72499-1X	72499-2X
605273-2	Standard	3.73	706000-3X	72720X	706008X	707041X	72499-1X	72499-2X
605273-3	Standard	3.45	706000-21X	72721X	706007X	707041X	72499-1X	72499-2X
1989 1/2 1A Aerostar Van								
605434-1	Standard	3.73	706000-20X	72720X	706008X	707041X	72499-1X	72499-2X

(7) See Ring Gear & Pinion Kits in XGI Catalog for ratio & tooth combinations.

(8) See Differential Case Assy Kits in XGI Catalog for spline data & ratios.

Ford 1979

Model 44 /216 Rear Axles for

F-100, F-150

Ford Model 44 /216 Rear Axles Exploded View

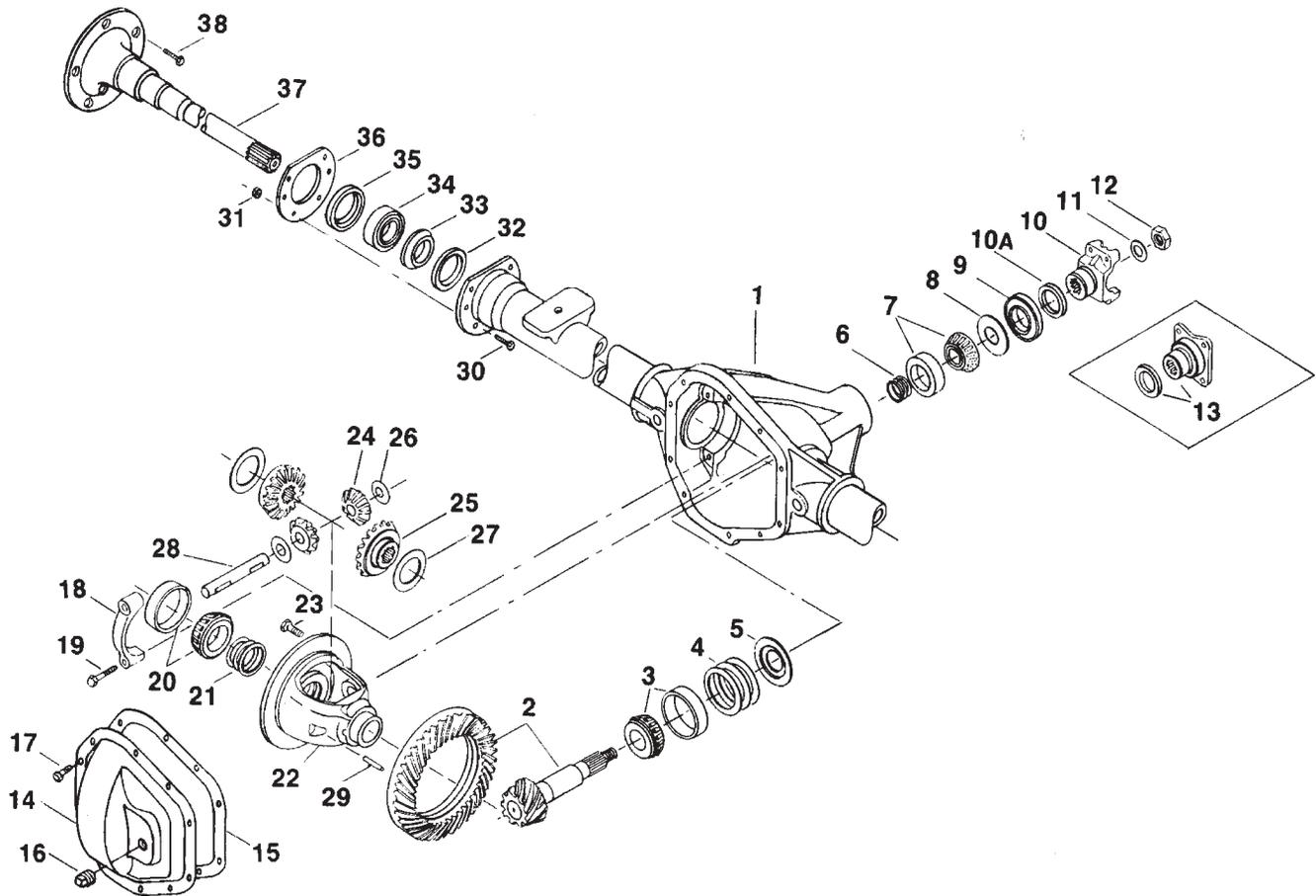

Ford Model 44 /216 Rear Axles Parts Listing

ITEM NO.	PART NUMBER	DESCRIPTION	ITEM NO.	PART NUMBER	DESCRIPTION
1	— ⁽³⁾	Housing – Axle Service	17	34279	Bolt – Carrier Cover (qty 10)
2	— ⁽¹⁾	Drive Pinion & Gear Assembly	18	— ⁽³⁾	Differential Bearing Cap
3	706031X	KIT – Inner Pinion Bearing	19	48632-1	Bolt – Differential Bearing Cap
4	— ⁽⁴⁾	Inner Pinion Bearing Shims (see shim packages)	20	706032X	KIT – Differential Bearing
5	30765	Baffle – Pinion Bearing	21	706086X	PKG – Diff Bearing Shim (inc 15)
	706376X	PKG – Diff & Pinion Bearing Shim (inc items 4, 6, 11, 12, 15, 21)	22	— ⁽⁴⁾	Case – Differential
6	— ⁽⁴⁾	Outer Pinion Bearing Shims (see shim packages)	23	30187	Bolt – Drive Gear (qty 10)
	706358X	PKG – Pinion Bearing Shim (inc items 4, 6, 11, 12, 15)	24	17717	Pinion – Differential
7	706030X	KIT – Outer Pinion Bearing	25	31487	Gear – Differential
8	13575	Slinger – Outer Pinion Bearing	26	13338-3	Thrustwasher – Diff Pinion
9	39118	Seal – Pinion Oil	27	32121	Thrustwasher – Diff Gear
10	2-4-6111X	End Yoke or Assembly (inc 10A)	28	17878	Shaft – Differential
10A	41498	Slinger – End Yoke	29	13449	Lock – Differential Shaft
11	30186	Washer – Pinion Nut	30	— ⁽³⁾	Bolt – Brake Mounting
12	30185	Pinion Nut	31	— ⁽³⁾	Nut – Brake Mounting
13	—	Companion Flange Assembly		706763X	KIT – Unit Bearing & Seal (inc items 32, 33, 34, 35, 36)
	706112X	KIT – Carrier Cover (inc items 14, 15, 16, 17)	32	34419	Seal – Inboard Shaft
14	39015	Carrier Cover	33	38888	Retainer Ring – Wheel Bearing
15	34685	Gasket – Carrier Cover	34	565903	Wheel Bearing Assembly
16	36472	Plug – Carrier Cover	35	35239	Seal – Outboard Shaft
			36	39386	Retainer – Oil Seal
			37	— ⁽¹⁾	Axle Shaft Assembly
			38	38638	Bolt – Axle Shaft

(1) See "Bill of Material Table" below

(3) Contact Vehicle Manufacturer

(4) Not Sold Separately

Bill of Material Table

Axle			Axle Kits				Shaft & Joint Assy.	
Bill of Material	Diff. Type	Ratio	Ring Gear & Pinion Kit ⁽⁷⁾	Differential			Right Hand Shaft Assy.	Left Hand Shaft Assy.
				Case Assy. Kit ⁽⁸⁾	Case Kit	Inner Parts Kit		
1979 F-100 & F-150								
603973-1	Standard	2.72	706017-19X	706020X	706024X	706027X	71025-1X	71025-2X
603973-2	Standard	2.72	706017-19X	706020X	706024X	706027X	71025-1X	71025-2X

(7) See Ring Gear & Pinion Kits in XGI Catalog for ratio & tooth combinations.

(8) See Differential Case Assy Kits in XGI Catalog for spline data & ratios.

Ford 1978-1998

Model 60 /248 Rear Axles for

E-250, E-350

F-250, F-350

Ford Model 60 /248 Rear Axles Exploded View

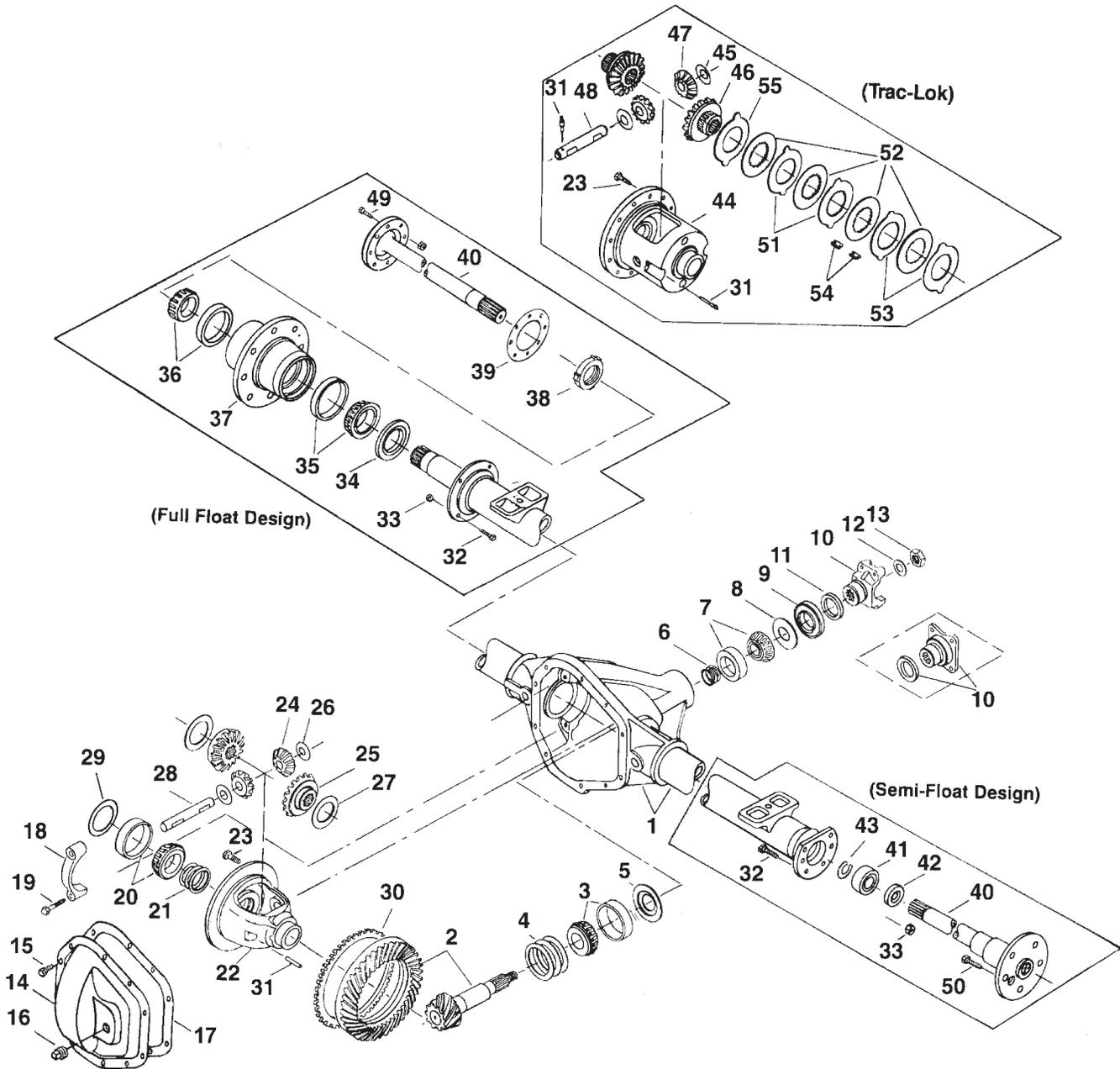

Ford Model 60 /248 Rear Axles Parts Listing

ITEM NO.	PART NUMBER	DESCRIPTION	ITEM NO.	PART NUMBER	DESCRIPTION
1	— ⁽³⁾	Housing – Axle Service	29	— ⁽²⁾	Spacer\Shim – Differential Bearing
2	— ⁽¹⁾	Drive Pinion & Gear Assembly	30	— ⁽²⁾	Tone Ring
3	706046X	KIT – Inner Pinion Bearing	31	— ⁽²⁾	Lock – Differential Shaft
	— ⁽²⁾	PKG – Diff & Pinion Bearing Shim (inc items 4, 6, 12, 13, 17, 21)	32	— ⁽³⁾	Bolt – Brake Mounting
	— ⁽²⁾	PKG – Diff & Pinion Bearing Shim (inc items 4, 6, 12, 13, 17)	33	— ⁽³⁾	Nut – Brake Mounting
4	— ⁽⁵⁾	Inner Pinion Bearing Shims	34	— ⁽²⁾	Seal – Hub (Full Float)
5	— ⁽²⁾	Baffle – Pinion Bearing	35	706179X	KIT – Inner Wheel Bearing (Full Float)
6	— ⁽⁴⁾	Outer Pinion Bearing Shims	36	706074X	KIT – Outer Wheel Bearing (Full Float)
7	706045X	KIT – Outer Pinion Bearing	37	— ⁽³⁾	Wheel Hub
8	42737	Thrustwasher	38	— ⁽²⁾	Spindle Nut (Full Float)
9	42449	Seal – Pinion Oil		— ⁽²⁾	Spindle Nut (Full Float - LH)
10	— ⁽²⁾	End Yoke/Companion Flange Assy	39	39697	Gasket (Full Float)
11	— ⁽²⁾	Slinger – End Yoke	40	— ⁽¹⁾	Shaft – Axle Flanged Drive
12	30275	Washer – Pinion Nut		— ⁽²⁾	KIT – Unit Bearing & Seal (Semi Float)
13	30271	Pinion Nut	41	566117	(inc items 17, 31, 41, 42) Wheel Bearing Assembly
	— ⁽²⁾	KIT – Carrier Cover (inc 14, 15, 16)	42	— ⁽²⁾	Seal – Inboard Oil
14	— ⁽²⁾	Carrier Cover	43	39213	Retainer – Axle Shaft (Semi Float)
15	— ⁽²⁾	Bolt – Carrier Cover	44	— ⁽⁴⁾	Case – Differential (t/l)
16	— ⁽²⁾	Plug – Carrier Cover	45	34730	Thrustwasher – Diff Pinion (t/l)
17	34687	Gasket – Carrier Cover	46	— ⁽²⁾	Gear – Differential (t/l)
	38615	RTV Silicone Sealant	47	34367	Pinion – Differential (t/l)
18	— ⁽³⁾	Differential Bearing Cap	48	30263	Shaft – Differential (t/l)
19	48632-1	Bolt – Differential Bearing Cap	49	— ⁽²⁾	Bolt – Axle Shaft (Full Float)
20	— ⁽²⁾	KIT – Differential Bearing	50	— ⁽²⁾	Bolt – Axle Shaft (Semi Float)
21	— ⁽²⁾	PKG – Differential Bearing Shim		— ⁽²⁾	KIT – Differential Plate & Disc (t/l)
22	— ⁽⁴⁾	Case – Differential (std)	51	— ⁽⁴⁾	(inc items 51, 52, 53, 54, 55) Plate – Differential Pressure (t/l)
23	— ⁽²⁾	Bolt – Drive Gear (qty 12)	52	— ⁽⁴⁾	Disc – Differential (t/l)
24	34367	Pinion – Differential (std)	53	— ⁽⁴⁾	Plate – Differential
25	— ⁽²⁾	Gear – Differential (std)	54	40835	Clip – Differential Clutch Retainer (t/l)
26	34730	Thrustwasher – Diff Pinion (std)	55	— ⁽⁴⁾	Spacer – Plate Preload
27	34729	Thrustwasher – Diff Gear (std)		— ⁽²⁾	KIT – RH Rear Axle Shaft
28	30263	Shaft – Differential (std)		— ⁽²⁾	KIT – LH Rear Axle Shaft

(1) See "Bill of Material Table" on next page

(2) See "Variable Parts Table" within this section

(3) Contact Vehicle Manufacturer

(4) Not Sold Separately

(5) See Camber/Casting Bushing Table at the end of the Ford section of this catalog

Ford Model 60 /248 Rear Axles

Bill of Material Table

Axle			Axle Kits				Shaft & Joint Assy.	
Bill of Material	Diff. Type	Ratio	Ring Gear & Pinion Kit ⁽⁷⁾	Differential			Right Hand Shaft Assy.	Left Hand Shaft Assy.
				Case Assy. Kit ⁽⁸⁾	Case Kit	Inner Parts Kit		
1979 F-250 Crew Cab - Full Float								
603725-5	Standard	3.73	706033-2X	706036X	706040X	706043X	35467-3	35467-3
603725-6	Trac Lok	3.73	706033-2X	708013	708014	707084X	35467-3	35467-3
603725-7	Standard	3.73	706033-2X	706036X	706040X	706043X	35467-3	35467-3
603725-9	Standard	4.10	706033-3X	706036X	706040X	706043X	35467-3	35467-3
603725-10	Trac Lok	4.10	706033-3X	708013	708014	707084X	35467-3	35467-3
603725-11	Standard	4.10	706033-3X	706036X	706040X	706043X	35467-3	35467-3
603725-12	Trac Lok	4.10	706033-3X	708013	708014	707084X	35467-3	35467-3
603725-13	Standard	4.56	706033-4X	706037X	706041X	706043X	35467-3	35467-3
603725-14	Trac Lok	4.56	706033-4X	707097X	706039X	707084X	35467-3	35467-3
603725-17	No Spin	4.10	706033-3X	38098	—	—	35467-3	35467-3
603725-18	Standard	3.54	706033-1X	706036X	706040X	706043X	35467-3	35467-3
603725-19	Trac Lok	3.54	706033-1X	708013	708014	707084X	35467-3	35467-3
603725-20	Standard	3.73	706033-2X	706036X	706040X	706043X	35467-3	35467-3
603725-21	Standard	4.10	706033-3X	706036X	706040X	706043X	35467-3	35467-3
603725-24	Trac Lok	4.10	706033-3X	708013	708014	707084X	35467-3	35467-3
1979 F-250 4X4 - Full Float								
603901-1	Standard	3.54	706033-1X	706036X	706040X	706043X	35467-3	35467-3
603901-2	Standard	3.54	706033-1X	706036X	706040X	706043X	35467-3	35467-3
603901-3	Standard	4.10	706033-3X	706036X	706040X	706043X	35467-3	35467-3
603901-4	Trac Lok	4.10	706033-3X	708013	708014	707084X	35467-3	35467-3
603901-5	Standard	4.10	706033-3X	706036X	706040X	706043X	35467-3	35467-3
603901-6	Trac Lok	4.10	706033-3X	708013	708014	707084X	35467-3	35467-3
603901-7	No Spin	4.10	706033-3X	38098	—	—	35467-3	35467-3
603901-8	No Spin	4.10	706033-3X	38098	—	—	35467-3	35467-3
603901-9	No Spin	3.54	706033-1X	38098	—	—	35467-3	35467-3
603901-10	Trac Lok	3.54	706033-1X	708013	708014	707084X	35467-3	35467-3
603901-11	Trac Lok	3.54	706033-1X	708013	708014	707084X	35467-3	35467-3
603901-12	Trac Lok	3.54	706033-1X	708013	708014	707084X	35467-3	35467-3
1979 F-250 4X2 - Full Float								
603926-1	Standard	3.73	706033-2X	706036X	706040X	706043X	35467-3	35467-3
603926-2	Trac Lok	3.73	706033-2X	708013	708014	707084X	35467-3	35467-3
603926-3	Trac Lok	4.10	706033-3X	708013	708014	707084X	35467-3	35467-3
603926-4	Standard	3.54	706033-1X	706036X	706040X	706043X	35467-3	35467-3
603926-5	Trac Lok	3.54	706033-1X	708013	708014	707084X	35467-3	35467-3
603926-6	Standard	4.10	706033-3X	706036X	706040X	706043X	35467-3	35467-3
603926-7	Standard	4.56	706033-4X	706037X	706041X	706043X	35467-3	35467-3
603926-8	No Spin	3.73	706033-2X	38098	—	—	35467-3	35467-3
1980-81 F-250 3/4 Ton 4X2, 4X4 Pick-Up - Semi Float								
603943-1	Standard	3.33	706807-1X	706840X	706842X	706844X	70867-1X	70867-2X
603943-2	Standard	3.54	706807-2X	706840X	706842X	706844X	70867-1X	70867-2X
603943-3	Standard	3.73	706807-3X	706840X	706842X	706844X	70867-1X	70867-2X
603943-4	Standard	4.10	706807-4X	706840X	706842X	706844X	70867-1X	70867-2X
603943-5	Trac Lok	3.33	706807-1X	707096X	706843X	707095X	70867-1X	70867-2X
603943-6	Trac Lok	3.54	706807-2X	707096X	706843X	707095X	70867-1X	70867-2X

(7) See Ring Gear & Pinion Kits in XGI Catalog for ratio & tooth combinations.

(8) See Differential Case Assy Kits in XGI Catalog for spline data & ratios.

Ford Model 60 /248 Rear Axles

Bill of Material Table

Axle			Axle Kits				Shaft & Joint Assy.	
Bill of Material	Diff. Type	Ratio	Ring Gear & Pinion Kit ⁽⁷⁾	Differential			Right Hand Shaft Assy.	Left Hand Shaft Assy.
				Case Assy. Kit ⁽⁸⁾	Case Kit	Inner Parts Kit		
1980 1/2 E-250 - Full Float								
605020-1	Standard	3.54	706033-1X	706036X	706040X	706043X	37560-1	37560-2
605020-2	Standard	3.73	706033-2X	706036X	706040X	706043X	37560-1	37560-2
605020-3	Standard	3.33	706807-1X	706036X	706040X	706043X	37560-1	37560-2
605020-4	Trac Lok	3.33	706807-1X	708013	708014	707084X	37560-1	37560-2
605020-5	Trac Lok	3.54	706033-1X	708013	708014	707084X	37560-1	37560-2
1981-81 1/2 E-250 Van - Semi Float								
605031-1	Standard	3.73	706807-3X	706840X	706842X	706844X	70867-3X	70867-4X
605031-2	Standard	3.54	706807-2X	706840X	706842X	706844X	70867-3X	70867-4X
605031-3	Trac Lok	3.54	706807-2X	707096X	706843X	707095X	70867-3X	70867-4X
605031-4	Standard	3.33	706807-1X	706840X	706842X	706844X	70867-3X	70867-4X
605031-5	Trac Lok	3.33	706807-1X	707096X	706843X	707095X	70867-3X	70867-4X
605031-6	Standard	4.10	706807-4X	706840X	706842X	706844X	70867-3X	70867-4X
605031-7	Trac Lok	4.10	706807-4X	707096X	706843X	707095X	70867-3X	70867-4X
1982-83 F-250 - Semi Float								
605086-1	Standard	3.33	706834-1X	706840X	706842X	706844X	70867-1X	70867-2X
605086-2	Standard	3.54	706834-2X	706840X	706842X	706844X	70867-1X	70867-2X
605086-3	Standard	3.73	706834-3X	706840X	706842X	706844X	70867-1X	70867-2X
605086-5	Trac Lok	3.33	706834-1X	707096X	706843X	707095X	70867-1X	70867-2X
605086-6	Trac Lok	3.54	706834-2X	707096X	706843X	707095X	70867-1X	70867-2X
605086-7	Trac Lok	3.73	706834-3X	707096X	706843X	707095X	70867-1X	70867-2X
1982-83 E-250 Van - Semi Float								
605089-1	Standard	3.73	706834-3X	706840X	706842X	706844X	70867-3X	70867-4X
605089-2	Standard	3.54	706834-2X	706840X	706842X	706844X	70867-3X	70867-4X
605089-3	Trac Lok	3.54	706834-2X	707096X	706843X	707095X	70867-3X	70867-4X
605089-4	Standard	3.33	706834-1X	706840X	706842X	706844X	70867-3X	70867-4X
605089-5	Trac Lok	3.33	706834-1X	707096X	706843X	707095X	70867-3X	70867-4X
605089-6	Standard	4.10	706834-4X	706840X	706842X	706844X	70867-3X	70867-4X
605089-7	Trac Lok	4.10	706834-4X	707096X	706843X	707095X	70867-3X	70867-4X
605089-8	Standard	3.54	706834-2X	706840X	706842X	706844X	70867-3X	70867-4X
605089-9	Trac Lok	3.54	706834-2X	707096X	706843X	707095X	70867-3X	70867-4X
1983 1/2 E-250 Van - Semi Float								
605179-1	Standard	4.10	706834-4X	706840X	706842X	706844X	70867-3X	70867-4X
605179-2	Trac Lok	4.10	706834-4X	707096X	706843X	707095X	70867-3X	70867-4X
605179-3	Standard	3.54	706834-2X	706840X	706842X	706844X	70867-3X	70867-4X
605179-4	Trac Lok	3.54	706834-2X	707096X	706843X	707095X	70867-3X	70867-4X
605179-5	Standard	3.54	706834-2X	706840X	706842X	706844X	70867-3X	70867-4X
605179-6	Trac Lok	3.54	706834-2X	707096X	706843X	707095X	70867-3X	70867-4X
605179-7	Standard	3.73	706834-3X	706840X	706842X	706844X	70867-3X	70867-4X
605179-8	Trac Lok	3.73	706834-3X	707096X	706843X	707095X	70867-3X	70867-4X
605179-9	Standard	4.10	706834-4X	706840X	706842X	706844X	70867-3X	70867-4X
1983 1/2 F-350 Pick-Up - Semi Float								
605145-1	Standard	3.54	706834-2X	706840X	706842X	706844X	70867-5X	70867-6X
605145-2	Trac Lok	3.54	706834-2X	707096X	706843X	707095X	70867-5X	70867-6X
605145-3	Standard	3.73	706834-3X	706840X	706842X	706844X	70867-5X	70867-6X
605145-4	Standard	4.10	706834-4X	706840X	706842X	706844X	70867-5X	70867-6X
605145-5	Trac Lok	4.10	706834-4X	707096X	706843X	707095X	70867-5X	70867-6X

(7) See Ring Gear & Pinion Kits in XGI Catalog for ratio & tooth combinations.

(8) See Differential Case Assy Kits in XGI Catalog for spline data & ratios.

Ford Model 60 /248 Rear Axles

Bill of Material Table

Axle			Axle Kits				Shaft & Joint Assy.	
Bill of Material	Diff. Type	Ratio	Ring Gear & Pinion Kit ⁽⁷⁾	Differential			Right Hand Shaft Assy.	Left Hand Shaft Assy.
				Case Assy. Kit ⁽⁸⁾	Case Kit	Inner Parts Kit		
1983 1/2 F-350 Chassis - Semi Float								
605146-1	Standard	3.73	706834-3X	706840X	706842X	706844X	70867-7X	70867-8X
605146-2	Standard	4.10	706834-4X	706840X	706842X	706844X	70867-7X	70867-8X
605146-3	Trac Lok	4.10	706834-4X	707096X	706843X	707095X	70867-7X	70867-8X
605146-4	Standard	3.54	706834-4X	706840X	706842X	706844X	70867-7X	70867-8X
605146-5	Trac Lok	3.54	706834-2X	707096X	706843X	707095X	70867-7X	70867-8X
1983 1/2-85 F-250 - Semi Float								
605169-2	Standard	3.54	706834-2X	706840X	706842X	706844X	70867-1X	70867-2X
605169-3	Standard	3.73	706834-3X	706840X	706842X	706844X	70867-1X	70867-2X
605169-5	Trac Lok	3.54	706834-2X	707096X	706843X	707095X	70867-1X	70867-2X
605169-6	Standard	4.10	706834-4X	706840X	706842X	706844X	70867-1X	70867-2X
605169-7	Standard	3.54	706834-2X	706840X	706842X	706844X	70867-1X	70867-2X
605169-8	Trac Lok	3.54	706834-2X	707096X	706843X	707095X	70867-1X	70867-2X
605169-9	Standard	3.73	706834-3X	706840X	706842X	706844X	70867-1X	70867-2X
605169-10	Trac Lok	3.73	706834-3X	707096X	706843X	707095X	70867-1X	70867-2X
605169-11	Standard	4.10	706834-4X	706840X	706842X	706844X	70867-1X	70867-2X
605169-12	Trac Lok	4.10	706834-4X	707096X	706843X	707095X	70867-1X	70867-2X
605169-13	Standard	4.10	706834-4X	706840X	706842X	706844X	70867-1X	70867-2X
605169-14	Trac Lok	4.10	706834-4X	707096X	706843X	707095X	70867-1X	70867-2X
605169-15	Standard	3.54	706834-2X	706840X	706842X	706844X	70867-1X	70867-2X
605169-16	Trac Lok	3.54	706834-2X	707096X	706843X	707095X	70867-1X	70867-2X
1984-85 E-250 Van - Semi Float								
605211-1	Standard	3.54	706834-2X	706840X	706842X	706844X	70867-3X	70867-4X
605211-2	Trac Lok	3.54	706834-2X	707096X	706843X	707095X	70867-3X	70867-4X
605211-3	Trac Lok	3.73	706834-3X	707096X	706843X	707095X	70867-3X	70867-4X
605211-4	Trac Lok	4.10	706834-4X	707096X	706843X	707095X	70867-3X	70867-4X
1985 E-250 Van SRW - Semi Float								
605251-1	Standard	3.54	706834-2X	706840X	706842X	706844X	70867-3X	70867-4X
605251-2	Trac Lok	3.54	706834-2X	707096X	706843X	707095X	70867-3X	70867-4X
605251-3	Standard	3.73	706834-3X	706840X	706842X	706844X	70867-3X	70867-4X
605251-4	Trac Lok	3.73	706834-3X	707096X	706843X	707095X	70867-3X	70867-4X
1985 F-250 - Semi Float								
605254-1	Standard	3.54	706834-2X	706840X	706842X	706844X	70867-15X	70867-16X
605254-2	Trac Lok	3.54	706834-2X	707096X	706843X	707095X	70867-15X	70867-16X
605254-3	Trac Lok	3.73	706834-3X	706840X	706842X	706844X	70867-15X	70867-16X
605254-4	Standard	4.10	706834-4X	706840X	706842X	706844X	70867-15X	70867-16X
605254-5	Trac Lok	4.10	706834-4X	707096X	706843X	707095X	70867-15X	70867-16X
1986-88 E-250 Van SRW - Semi Float								
605298-1	Standard	3.54	706834-2X	706840X	706842X	706844X	70867-17X	70867-18X
605298-2	Trac Lok	3.54	706834-2X	707096X	706843X	707095X	70867-17X	70867-18X
605298-3	Standard	3.73	706834-3X	706840X	706842X	706844X	70867-17X	70867-18X
605298-4	Trac Lok	3.73	706834-3X	707096X	706843X	707095X	70867-17X	70867-18X
1988 E-350 Van SRW - Full Float								
605355-1	Standard	3.54	706033-1X	706036X	706040X	706043X	39260-7	39260-8
605355-2	Trac Lok	3.54	706033-1X	708013	708014	707084X	39260-7	39260-8
605355-3	Standard	4.10	706033-3X	706036X	706040X	706043X	39260-7	39260-8
605355-4	Trac Lok	4.10	706033-3X	708013	708014	707084X	39260-7	39260-8

(7) See Ring Gear & Pinion Kits in XGI Catalog for ratio & tooth combinations.

(8) See Differential Case Assy Kits in XGI Catalog for spline data & ratios.

Ford Model 60 /248 Rear Axles

Bill of Material Table

Axle			Axle Kits				Shaft & Joint Assy.	
Bill of Material	Diff. Type	Ratio	Ring Gear & Pinion Kit ⁽⁷⁾	Differential			Right Hand Shaft Assy.	Left Hand Shaft Assy.
				Case Assy. Kit ⁽⁸⁾	Case Kit	Inner Parts Kit		
1989 E-250 Van SRW - Semi Float								
605414-1	Standard	3.54	706834-2X	707211X	707212X	706844X	70867-17X	70867-18X
605414-2	Standard	3.73	706834-3X	707211X	707212X	706844X	70867-17X	70867-18X
605414-3	Trac Lok	3.73	706834-3X	707163X	707164X	707095X	70867-17X	70867-18X
1989 E-350 Van SRW - Full Float								
605413-1	Standard	3.54	706033-1X	707213X	707214X	706043X	39260-7	39260-8
605413-2	Standard	4.10	706033-3X	707213X	707214X	706043X	39260-7	39260-8
605413-3	Trac Lok	4.10	706033-3X	707143X	707144X	707084X	39260-7	39260-8
1990-91 1/2 E-250 Van SRW - Semi Float - ABS								
605419-1	Standard	3.54	706834-2X	707211X	707212X	706844X	70867-17X	70867-18X
605419-2	Standard	3.73	706834-3X	707211X	707212X	706844X	70867-17X	70867-18X
605419-3	Trac Lok	3.73	706834-3X	707163X	707164X	707095X	70867-17X	70867-18X
1990-91 1/2 E-250 Van SRW - Full Float - ABS								
605420-1	Standard	3.54	706033-1X	707213X	707214X	706043X	39260-7	39260-8
605420-2	Standard	4.10	706033-3X	707213X	707214X	706043X	39260-7	39260-8
605420-3	Trac Lok	4.10	706033-3X	707143X	707144X	707084X	39260-7	39260-8
605420-4	Trac Lok	3.54	706033-1X	707143X	707144X	707084X	39260-7	39260-8
1992 E-250 Van SRW - Semi Float - ABS								
605556-1	Standard	3.54	706834-2X	707211X	707212X	706844X	70867-17X	70867-18X
605556-2	Standard	3.73	706834-3X	707211X	707212X	706844X	70867-17X	70867-18X
605556-3	Trac Lok	3.73	706834-3X	707163X	707164X	707095X	70867-17X	70867-18X
605556-4	Standard	3.54	706834-2X	707211X	707212X	706844X	70867-17X	70867-18X
605556-5	Standard	3.73	706834-3X	707211X	707212X	706844X	70867-17X	70867-18X
605556-6	Trac Lok	3.73	706834-3X	707163X	707164X	707095X	70867-17X	70867-18X
1992-93 1/2 E-350 Van SRW - Full Float - ABS								
605487-1	Standard	3.54	706033-1X	707213X	707214X	706043X	39260-7	39260-8
605487-2	Standard	4.10	706033-3X	707213X	707214X	706043X	39260-7	39260-8
605487-3	Trac Lok	4.10	706033-3X	707143X	707144X	707084X	39260-7	39260-8
605487-4	Trac Lok	3.54	706033-1X	707143X	707144X	707084X	39260-7	39260-8
1993-94 E-250 Van SRW - Semi Float - ABS								
605623-1	Standard	3.54	706834-3X	707211X	707212X	706844X	70867-17X	70867-18X
1993-95 E-250 Van SRW - Semi Float - ABS								
605569-1	Standard	3.54	706834-2X	707211X	707212X	706844X	70867-17X	70867-18X
605569-2	Standard	3.73	706834-3X	707211X	707212X	706844X	70867-17X	70867-18X
605569-3	Trac Lok	3.73	706834-3X	707163X	707164X	707095X	70867-17X	70867-18X
1993 1/2-94 E-350 Van SRW - Full Float - ABS								
605624-1	Standard	4.09	706033-13X	707213X	707214X	706043X	39260-7	39260-8
605624-2	Trac Lok	4.09	706033-13X	707143X	707144X	707084X	39260-7	39260-8
605624-3	Standard	3.54	706033-1X	707213X	707214X	706043X	39260-7	39260-8
605624-4	Trac Lok	3.54	706033-1X	707143X	707144X	707084X	39260-7	39260-8
1994-94 1/2 E-350 Van SRW - Full Float - ABS								
605670-1	Standard	4.09	706033-13X	707213X	707214X	706043X	39260-7	39260-8
605670-2	Trac Lok	4.09	706033-13X	707143X	707144X	707084X	39260-7	39260-8
605670-3	Standard	3.54	706033-1X	707213X	707214X	706043X	39260-7	39260-8
605670-4	Trac Lok	3.54	706033-1X	707143X	707144X	707084X	39260-7	39260-8

(7) See Ring Gear & Pinion Kits in XGI Catalog for ratio & tooth combinations.

(8) See Differential Case Assy Kits in XGI Catalog for spline data & ratios.

Ford Model 60 /248 Rear Axles

Bill of Material Table

Axle			Axle Kits				Shaft & Joint Assy.	
Bill of Material	Diff. Type	Ratio	Ring Gear & Pinion Kit ⁽⁷⁾	Differential			Right Hand Shaft Assy.	Left Hand Shaft Assy.
				Case Assy. Kit ⁽⁸⁾	Case Kit	Inner Parts Kit		
1994-95 E-350 Van SRW - Full Float - ABS								
605639-1	Standard	3.54	706033-1X	707213X	707214X	706043X	39260-7	39260-8
605639-2	Trac Lok	3.54	706033-1X	707143X	707144X	707084X	39260-7	39260-8
605639-3	Standard	3.73	706033-2X	707213X	707214X	706043X	39260-7	39260-8
605639-4	Trac Lok	3.73	706033-2X	707143X	707144X	707084X	39260-7	39260-8
605639-5	Standard	4.09	706033-13X	707213X	707214X	706043X	39260-7	39260-8
605639-6	Trac Lok	4.09	706033-13X	707143X	707144X	707084X	39260-7	39260-8
1994 1/2 E-350 Van SRW - Full Float - ABS								
605713-1	Standard	4.09	706033-13X	707213X	707214X	706043X	39260-7	39260-8
605713-2	Trac Lok	4.09	706033-13X	707143X	707144X	707084X	39260-7	39260-8
605713-3	Standard	3.54	706033-1X	707213X	707214X	706043X	39260-7	39260-8
605713-4	Trac Lok	3.54	706033-1X	707143X	707144X	707084X	39260-7	39260-8
1995-96 E-250 Van SRW - Semi Float - ABS								
605700-1	Standard	3.54	706834-2X	707211X	707212X	706844X	75344-1X	75344-2X
605700-2	Standard	3.73	706834-3X	707211X	707212X	706844X	75344-1X	75344-2X
605700-3	Trac Lok	3.73	706834-3X	707163X	707164X	707095X	75344-1X	75344-2X
605700-4	Standard	3.54	706834-2X	707211X	707212X	706844X	75344-1X	75344-2X
605700-5	Standard	3.73	706834-3X	707211X	707212X	706844X	75344-1X	75344-2X
605700-6	Trac Lok	3.73	706834-3X	707163X	707164X	707095X	75344-1X	75344-2X
1995-96 E-350 Van SRW - Full Float - ABS								
605684-1	Standard	3.54	706033-1X	707213X	707214X	706043X	39260-7	39260-8
605684-2	Standard	3.54	706033-1X	707213X	707214X	706043X	39260-7	39260-8
605684-3	Standard	4.09	706033-13X	707213X	707214X	706043X	39260-7	39260-8
605684-4	Trac Lok	4.09	706033-13X	707143X	707144X	707084X	39260-7	39260-8
605684-5	Standard	3.73	706033-2X	707213X	707214X	706043X	39260-7	39260-8
605684-6	Trac Lok	3.73	706033-2X	707143X	707144X	707084X	39260-7	39260-8
605684-7	Standard	3.54	706033-1X	707213X	707214X	706043X	39260-7	39260-8
605684-8	Trac Lok	3.54	706033-1X	707143X	707144X	707084X	39260-7	39260-8
605684-9	Standard	4.09	706033-13X	707213X	707214X	706043X	39260-7	39260-8
605684-10	Trac Lok	4.09	706033-13X	707143X	707144X	707084X	39260-7	39260-8
605684-11	Standard	3.73	706033-2X	707213X	707214X	706043X	39260-7	39260-8
605684-12	Trac Lok	3.73	706033-2X	707143X	707144X	707084X	39260-7	39260-8
605685-1	Standard	3.55	706033-15X	707387X	707214X	707389X	43811-16	43811-17
605685-2	Trac Lok	3.55	706033-15X	707388X	707144X	707390X	43811-16	43811-17
605685-3	Standard	4.10	706033-16X	707387X	707214X	707389X	43811-16	43811-17
605685-4	Trac Lok	4.10	706033-16X	707388X	707144X	707390X	43811-16	43811-17
605685-5	Standard	3.55	706033-15X	707387X	707214X	707389X	43811-16	43811-17
605685-6	Trac Lok	3.55	706033-15X	707388X	707144X	707390X	43811-16	43811-17
605685-7	Standard	4.10	706033-16X	707387X	707214X	707389X	43811-16	43811-17
605685-8	Trac Lok	4.10	706033-16X	707388X	707144X	707390X	43811-16	43811-17
1995-97 E-250 Van SRW - Semi Float - ABS								
605750-1	Standard	3.73	706834-3X	707211X	707212X	706844X	75344-1X	75344-2X
1996 E-350 Van SRW - Full Float - ABS								
605843-1	Standard	3.55	706033-15X	707387X	707214X	707389X	43811-16	43811-17
605843-2	Trac Lok	3.55	706033-15X	707388X	707144X	707390X	43811-16	43811-17
605843-3	Standard	4.10	706033-16X	707387X	707214X	707389X	43811-16	43811-17
605843-4	Trac Lok	4.10	706033-16X	707388X	707144X	707390X	43811-16	43811-17

(7) See Ring Gear & Pinion Kits in XGI Catalog for ratio & tooth combinations.

(8) See Differential Case Assy Kits in XGI Catalog for spline data & ratios.

Ford Model 60 /248 Rear Axles

Bill of Material Table

Axle			Axle Kits				Shaft & Joint Assy.	
Bill of Material	Diff. Type	Ratio	Ring Gear & Pinion Kit ⁽⁷⁾	Differential			Right Hand Shaft Assy.	Left Hand Shaft Assy.
				Case Assy. Kit ⁽⁸⁾	Case Kit	Inner Parts Kit		
1996-96 1/2 E-250 Van SRW - Semi Float - ABS								
605841-1	Standard	3.54	706834-2X	707211X	707212X	706844X	75344-1X	75344-2X
605841-2	Trac Lok	3.54	706834-3X	707163X	707164X	707095X	75344-1X	75344-2X
605841-3	Standard	3.73	706834-3X	707211X	707212X	706844X	75344-1X	75344-2X
605841-4	Trac Lok	3.73	706834-3X	707163X	707164X	707095X	75344-1X	75344-2X
1996-96 1/2 E-350 Van SRW - Full Float - ABS								
605842-1	Standard	3.54	706033-1X	707213X	707214X	706043X	39260-7	39260-8
605842-2	Trac Lok	3.54	706033-1X	707143X	707144X	707084X	39260-7	39260-8
605842-3	Standard	3.73	706033-2X	707213X	707214X	706043X	39260-7	39260-8
605842-4	Trac Lok	3.73	706033-2X	707143X	707144X	707084X	39260-7	39260-8
605842-5	Standard	4.09	706033-13X	707213X	707214X	706043X	39260-7	39260-8
605842-6	Trac Lok	4.09	706033-13X	707143X	707144X	707084X	39260-7	39260-8
1996-97 E-250 Van SRW - Semi Float - ABS								
605859-1	Standard	3.73	706834-3X	707211X	707212X	706844X	75344-1X	75344-2X
1996-99 E-250 Van SRW - Semi Float - ABS								
605920-1	Standard	3.73	706834-3X	707211X	707212X	706844X	75344-1X	75344-2X
605921-1	Trac Lok	3.73	706834-3X	707163X	707164X	707095X	75344-1X	75344-2X
1996 1/2 E-350 Van SRW - Full Float - ABS								
605934-1	Standard	3.54	706033-1X	707213X	707214X	706043X	39260-7	39260-8
605934-2	Trac Lok	3.54	706033-1X	707449X	707144X	707084-1X	39260-7	39260-8
605934-3	Standard	3.73	706033-2X	707213X	707214X	706043X	39260-7	39260-8
605934-4	Trac Lok	3.73	706033-2X	707449X	707144X	707084-1X	39260-7	39260-8
605934-5	Standard	4.09	706033-13X	707213X	707214X	706043X	39260-7	39260-8
605934-6	Trac Lok	4.09	706033-13X	707449X	707144X	707084-1X	39260-7	39260-8
605935-1	Standard	3.55	706033-15X	707387X	707214X	707389X	43811-16	43811-17
605935-2	Trac Lok	3.55	706033-15X	707432X	707144X	707434X	43811-16	43811-17
605935-3	Standard	4.10	706033-16X	707387X	707214X	707389X	43811-16	43811-17
605935-4	Trac Lok	4.10	706033-16X	707432X	707144X	707434X	43811-16	43811-17
1996 1/2-97 E-250 Van SRW - Semi Float - ABS								
605933-1	Standard	3.54	706834-2X	707211X	707212X	706844X	75344-1X	75344-2X
605933-3	Standard	3.73	706834-3X	707211X	707212X	706844X	75344-1X	75344-2X
605933-4	Trac Lok	3.73	706834-3X	707163X	707164X	707095X	75344-1X	75344-2X
1997 1/2 E-250 Van SRW - Semi Float - ABS								
605947-1	Standard	3.73	708125-4	707211-1X	707212-1X	706844X	75344-1X	75344-2X
605947-2	Trac Lok	3.73	708125-4	707427X	707428X	707435X	75344-1X	75344-2X
605947-3	Standard	4.09	708125-5	707211-1X	707212-1X	706844X	75344-1X	75344-2X
605947-4	Trac Lok	4.09	708125-5	707427X	707428X	707435X	75344-1X	75344-2X
1997 1/2 E-350 Van SRW - Full Float - ABS								
605948-1	Standard	3.55	708125-6	707387-1X	707214-1X	707389X	43811-16	43811-17
605948-2	Trac Lok	3.55	708125-6	707432X	707433X	707434X	43811-16	43811-17
605948-3	Standard	3.73	708125-4	707387-1X	707214-1X	707389X	43811-16	43811-17
605948-4	Trac Lok	3.73	708125-4	707432X	707433X	707434X	43811-16	43811-17
605949-1	Standard	4.10	708125-5	707387-1X	707214-1X	707389X	43811-16	43811-17
605949-2	Trac Lok	4.10	708125-5	707432X	707433X	707434X	43811-16	43811-17
1997 1/2-98 E-250 Van SRW - Semi Float - ABS								
606029-1	Standard	4.09	708125-5	707211-1X	707212-1X	706844X	75344-1X	75344-2X
606029-2	Trac Lok	4.09	708125-5	707427X	707428X	707435X	75344-1X	75344-2X

(7) See Ring Gear & Pinion Kits in XGI Catalog for ratio & tooth combinations.

(8) See Differential Case Assy Kits in XGI Catalog for spline data & ratios.

Ford Model 60 /248 Rear Axles

Bill of Material Table

Axle			Axle Kits				Shaft & Joint Assy.	
Bill of Material	Diff. Type	Ratio	Ring Gear & Pinion Kit ⁽⁷⁾	Differential			Right Hand Shaft Assy.	Left Hand Shaft Assy.
				Case Assy. Kit ⁽⁸⁾	Case Kit	Inner Parts Kit		
1998 E-350 Van SRW - Full Float - ABS								
606049-1	Standard	3.55	708125-6	707387-1X	707214-1X	707389X	43811-16	43811-17
606049-2	Trac Lok	3.55	708125-6	707432X	707433X	707434X	43811-16	43811-17
606049-3	Standard	3.73	708125-4	707387-1X	707214-1X	707389X	43811-16	43811-17
606049-4	Trac Lok	3.73	708125-4	707432X	707433X	707434X	43811-16	43811-17
606050-1	Standard	4.10	708125-5	707387-1X	707214-1X	707389X	43811-16	43811-17
606050-2	Trac Lok	4.10	708125-5	707432X	707433X	707434X	43811-16	43811-17
1998 E-250 Van SRW - Semi Float - ABS								
606163-1	Trac Lok	4.09	708125-5	707427X	707428X	707435X	75344-1X	75344-2X
1998-98 1/2 E-250 Van SRW - Semi Float - ABS								
606017-1	Standard	3.73	708125-4	707211-1X	707212-1X	706844X	75344-1X	75344-2X
606017-2	Trac Lok	3.73	708125-4	707427X	707428X	707435X	75344-1X	75344-2X
606017-3	Standard	4.09	708125-5	707211-1X	707212-1X	706844X	75344-1X	75344-2X
606017-4	Trac Lok	4.09	708125-5	707427X	707428X	707435X	75344-1X	75344-2X
1998 1/2-99 E-250 Van SRW - Semi Float - ABS								
606102-1	Trac Lok	4.09	708125-5	707427X	707428X	707435X	75344-1X	75344-2X
606161-1	Standard	3.73	708125-4	707211-1X	707212-1X	706844X	75344-1X	75344-2X
606161-2	Trac Lok	3.73	708125-4	707427X	707428X	707435X	75344-1X	75344-2X
606161-3	Standard	4.09	708125-5	707211-1X	707212-1X	706844X	75344-1X	75344-2X
606161-4	Trac Lok	4.09	708125-5	707427X	707428X	707435X	75344-1X	75344-2X
1998 1/2-99 E-350 Van SRW - Full Float - ABS								
606162-1	Standard	3.55	708125-6	707387-1X	707214-1X	707389X	43811-16	43811-17
606162-2	Trac Lok	3.55	708125-6	707432X	707433X	707434X	43811-16	43811-17
606162-3	Standard	3.73	708125-4	707387-1X	707214-1X	707389X	43811-16	43811-17
606162-4	Trac Lok	3.73	708125-4	707432X	707433X	707434X	43811-16	43811-17
606162-5	Standard	4.10	718125-5	707387-1X	707214-1X	707389X	43811-16	43811-17
606162-6	Trac Lok	4.10	707430-3X	707432X	707433X	707434X	43811-16	43811-17

(7) See Ring Gear & Pinion Kits in XGI Catalog for ratio & tooth combinations.

(8) See Differential Case Assy Kits in XGI Catalog for spline data & ratios.

Ford Model 60 /248 Rear Axles Variable Parts Listing

Kits & Parts - Use With All Applications							
Description & Item Number (Refer to "Exploded View" at the front of this section)			Bills of Material				
			603725	603901 603926	603943	605020	605031
1	PKG – Diff & Pinion Bearing Shim	-	706375X	706674X	706798X	706674X	706798X
2	PKG – Diff & Pinion Bearing Shim	-	706359X	706672X	706796X	706672X	706796X
3	Baffle – Pinion Bearing	5	30982	30982	30982	30982	30982
4	End Yoke/Companion Flange Assy	10	2-4-3801X	2-4-5311X	2-4-5311X	2-4-5311X	2-4-5311X
5	Slinger – End Yoke	11	34952	34592	34592	41195	34592
6	KIT – Carrier Cover	-	707108X	707108X	707108X	707108X	707108X
7	Carrier Cover	14	42799-2	42799-2	42799-2	42799-2	42799-2
8	Bolt – Carrier Cover	15	34822	34822	34822	34822	34822
9	Plug – Carrier Cover	16	43180	43180	43180	43180	43180
10	KIT – Differential Bearing	20	706047X	706047X	706047X	706047X	706047X
11	PKG – Differential Bearing Shim	21	708012	708012	708012	708012	708012
12	Bolt – Drive Gear (qty 12)	23	30266	30266	30266	30266	30266
13	Gear – Differential (std)	25	34394	34394	39232	34394	39232
14	Spacer/Shim – Differential Bearing	29	—	—	—	—	—
15	Tone Ring	30	—	—	—	—	—
16	Lock – Differential Shaft	31	44810	44810	40131-1	44810	40131-1
17	Seal – Hub (Full Float)	34	46004	46004	—	46004	—
18	Spindle Nut (Full Float)	38	—	—	—	—	—
19	Spindle Nut (Full Float - LH)	-	—	—	—	—	—
20	KIT – Unit Bearing & Seal (Semi Float)	-	—	—	706847X	—	706847X
21	Seal – Inboard Oil	42	—	—	39246	—	39246
22	Gear – Differential (t/l)	46	35803	35803	39256	35803	39256
23	Bolt – Axle Shaft (Full Float)	49	—	—	—	39694	—
24	Bolt – Axle Shaft (Semi Float)	50	—	—	39414	—	39414
25	KIT – Differential Plate & Disc (t/l)	-	707083X	707083X	707083X	707083X	707083X
26	KIT – RH Rear Axle Shaft	-	—	—	706746-1X	—	706746-3X
27	KIT – LH Rear Axle Shaft	-	—	—	706746-2X	—	706746-4X
			605086	605089	605145	605146	605169
1	PKG – Diff & Pinion Bearing Shim	-	706838X	706838X	706838X	706838X	706838X
2	PKG – Diff & Pinion Bearing Shim	-	706836X	706836X	706836X	706836X	706836X
3	Baffle – Pinion Bearing	5	30982	30982	30982	30982	30982
4	End Yoke/Companion Flange Assy	10	2-4-5311X	2-4-5311X	2-4-5311X	2-4-5311X	2-4-8051X
5	Slinger – End Yoke	11	34592	34592	34592	34592	41195
6	KIT – Carrier Cover	-	707108X	707108X	707108X	707106X	707108X
7	Carrier Cover	14	42799-2	42799-2	42799-2	42799-1	42799-2
8	Bolt – Carrier Cover	15	34822	34822	34822	34822	34822
9	Plug – Carrier Cover	16	43180	43180	43180	43180	43180
10	KIT – Differential Bearing	20	706047X	706047X	706047X	706047X	706047X
11	PKG – Differential Bearing Shim	21	708012	708012	708012	708012	708012
12	Bolt – Drive Gear (qty 12)	23	30266	30266	30266	30266	30266
13	Gear – Differential (std)	25	39232	39232	39232	39232	39232
14	Spacer/Shim – Differential Bearing	29	—	—	—	—	—
15	Tone Ring	30	—	—	—	—	—
16	Lock – Differential Shaft	31	40131-1	40131-1	40131-1	40131-1	40131-1
17	Seal – Hub (Full Float)	34	—	—	—	—	—
18	Spindle Nut (Full Float)	38	—	—	—	—	—
19	Spindle Nut (Full Float - LH)	-	—	—	—	—	—
20	KIT – Unit Bearing & Seal (Semi Float)	-	706847X	706847X	706847X	706847X	706847X
21	Seal – Inboard Oil	42	39246	39246	39246	39246	39246
22	Gear – Differential (t/l)	46	39256	39256	39256	39256	39256
23	Bolt – Axle Shaft (Full Float)	49	—	—	—	—	—
24	Bolt – Axle Shaft (Semi Float)	50	39414	39414	40751/40752	40751/40752	39414
25	KIT – Differential Plate & Disc (t/l)	-	707083X	707083X	707083X	707083X	707083X
26	KIT – RH Rear Axle Shaft	-	706846-1X	706846-3X	706846-5X	706846-7X	706846-1X
27	KIT – LH Rear Axle Shaft	-	706846-2X	706846-4X	706846-6X	706846-8X	706846-2X

(See next page for additional bills of material)

Ford Model 60 /248 Rear Axles Variable Parts Listing

Kits & Parts - Use With All Applications							
Description & Item Number (Refer to "Exploded View" at the front of this section)			Bills of Material				
			605179 605211 605251	605254	605298	605355	605413
1	PKG – Diff & Pinion Bearing Shim	-	706838X	706838X	706838X	706674X	706674X
2	PKG – Diff & Pinion Bearing Shim	-	706836X	706836X	706836X	706672X	706672X
3	Baffle – Pinion Bearing	5	30982	30982	30982	30982	30982
4	End Yoke/Companion Flange Assy	10	2-4-8051X	2-4-8051X	2-4-8051X	2-4-8051X	2-4-8051X
5	Slinger – End Yoke	11	41195	41195	41195	41195	41195
6	KIT – Carrier Cover	-	707108X	707106X	707108X	707108X	707108X
7	Carrier Cover	14	42799-2	42799-1	42799-2	42799-2	42799-2
8	Bolt – Carrier Cover	15	34822	34822	34822	34822	34822
9	Plug – Carrier Cover	16	43180	43180	43180	43180	43180
10	KIT – Differential Bearing	20	706047X	706047X	706047X	706047X	706047X
11	PKG – Differential Bearing Shim	21	708012	708012	708012	708012	708012
12	Bolt – Drive Gear (qty 12)	23	30266	30266	30266	30266	30266
13	Gear – Differential (std)	25	39232	39232	39232	34394	34394
14	Spacer\Shim – Differential Bearing	29	—	—	—	—	42563
15	Tone Ring	30	—	—	—	—	—
16	Lock – Differential Shaft	31	40131-1	40131-1	40131-1	44810	44810
17	Seal – Hub (Full Float)	34	—	—	—	46004	46004
18	Spindle Nut (Full Float)	38	—	—	—	43075	43075
19	Spindle Nut (Full Float - LH)	-	—	—	—	43076	43076
20	KIT – Unit Bearing & Seal (Semi Float)	-	706847X	706847X	706847X	—	—
21	Seal – Inboard Oil	42	39246	39246	39246	—	—
22	Gear – Differential (t/l)	46	39256	39256	39256	35803	35803
23	Bolt – Axle Shaft (Full Float)	49	—	—	—	39694	39694
24	Bolt – Axle Shaft (Semi Float)	50	39414	41554	44827	—	—
25	KIT – Differential Plate & Disc (t/l)	-	707083X	707083X	707083X	707083X	707083X
26	KIT – RH Rear Axle Shaft	-	706846-3X	—	706846-17X	—	—
27	KIT – LH Rear Axle Shaft	-	706846-4X	—	706846-18X	—	—
			605414	605419	605420	605487	605556
1	PKG – Diff & Pinion Bearing Shim	-	706838X	706838X	706674X	706674X	706838X
2	PKG – Diff & Pinion Bearing Shim	-	706836X	706836X	706672X	706672X	706836X
3	Baffle – Pinion Bearing	5	30982	30982	30982	30982	30982
4	End Yoke/Companion Flange Assy	10	2-4-8051X	2-4-8051X	2-4-8051X	2-4-8051X	2-4-8051X
5	Slinger – End Yoke	11	41195	41195	41195	41195	41195
6	KIT – Carrier Cover	-	707108X	707217X	707217X	707217X	707217X
7	Carrier Cover	14	42799-2	42799-2	42799-2	42799-2	42799-2
8	Bolt – Carrier Cover	15	34822	34822	34822	34822	34822
9	Plug – Carrier Cover	16	43180	43181	43181	43181	43181
10	KIT – Differential Bearing	20	706047X	706047X	706047X	706047X	706047X
11	PKG – Differential Bearing Shim	21	708012	708012	708012	708012	708012
12	Bolt – Drive Gear (qty 12)	23	30266	30266	30266	30266	30266
13	Gear – Differential (std)	25	39232	39232	34394	34394	39232
14	Spacer\Shim – Differential Bearing	29	42563	42563	42563	42563	42563
15	Tone Ring	30	—	42928	42928	42928	42928
16	Lock – Differential Shaft	31	40131-1	40131-1	44810	44810	40131-1
17	Seal – Hub (Full Float)	34	—	—	46004	46004	—
18	Spindle Nut (Full Float)	38	—	—	43075	43075	—
19	Spindle Nut (Full Float - LH)	-	—	—	43075	43075	—
20	KIT – Unit Bearing & Seal (Semi Float)	-	706847X	706847X	—	—	706847X
21	Seal – Inboard Oil	42	39246	39246	—	39246	39246
22	Gear – Differential (t/l)	46	39256	39256	35803	35803	39256
23	Bolt – Axle Shaft (Full Float)	49	—	—	39694	39694	—
24	Bolt – Axle Shaft (Semi Float)	50	44827	44827	—	—	44827
25	KIT – Differential Plate & Disc (t/l)	-	707083X	707083X	707083X	707083X	707083X
26	KIT – RH Rear Axle Shaft	-	706846-17X	706846-17X	—	—	706846-17X
27	KIT – LH Rear Axle Shaft	-	706846-18X	706846-18X	—	—	706846-18X

Ford Model 60 /248 Rear Axles Variable Parts Listing

Kits & Parts - Use With All Applications							
Description & Item Number (Refer to "Exploded View" at the front of this section)			Bills of Material				
			605569	605623	605624	605639	605670
1	PKG – Diff & Pinion Bearing Shim	-	706375X	706838X	706375X	706375X	706375X
2	PKG – Diff & Pinion Bearing Shim	-	706359X	706836X	706359X	706359X	706359X
3	Baffle – Pinion Bearing	5	30982	30982	30982	30982	30982
4	End Yoke/Companion Flange Assy	10	2-4-8051X	2-4-8051X	3-4-13031-1X	2-4-8051X	3-4-13031-1X
5	Slinger – End Yoke	11	41195	41195	41195	41195	41195
6	KIT – Carrier Cover	-	707217X	707217X	707217X	707217X	707217X
7	Carrier Cover	14	42799-2	42799-2	42799-2	42799-2	42799-2
8	Bolt – Carrier Cover	15	34822	34822	34822	34822	34822
9	Plug – Carrier Cover	16	43181	43181	43181	43181	43181
10	KIT – Differential Bearing	20	706047X	706047X	706047X	706047X	706047X
11	PKG – Differential Bearing Shim	21	708012	708012	708012	708012	708012
12	Bolt – Drive Gear (qty 12)	23	30266	30266	30266	30266	30266
13	Gear – Differential (std)	25	39232	39232	34394	34394	34394
14	Spacer/Shim – Differential Bearing	29	42563	42563	42563	42563	42563
15	Tone Ring	30	42928	42928	42928	42928	42928
16	Lock – Differential Shaft	31	40131-1	40131-1	44810	44810	44810
17	Seal – Hub (Full Float)	34	—	—	46004	46004	46004
18	Spindle Nut (Full Float)	38	—	—	43075	43075	43075
19	Spindle Nut (Full Float - LH)	-	—	—	43075	43075	43075
20	KIT – Unit Bearing & Seal (Semi Float)	-	706847X	706847X	—	—	—
21	Seal – Inboard Oil	42	39246	39246	—	—	—
22	Gear – Differential (t/l)	46	—	—	—	—	—
23	Bolt – Axle Shaft (Full Float)	49	—	—	45720	45720	45720
24	Bolt – Axle Shaft (Semi Float)	50	44827	44827	—	—	—
25	KIT – Differential Plate & Disc (t/l)	-	707083X	—	707083X	707083X	707083X
26	KIT – RH Rear Axle Shaft	-	706846-17X	706846-17X	—	—	—
27	KIT – LH Rear Axle Shaft	-	706846-18X	706846-18X	—	—	—
			605684	605685	605700	605713	605750
1	PKG – Diff & Pinion Bearing Shim	-	706375X	706375X	706375X	706375X	706375X
2	PKG – Diff & Pinion Bearing Shim	-	706359X	706359X	706359X	706359X	706359X
3	Baffle – Pinion Bearing	5	30982	30982	30982	30982	30982
4	End Yoke/Companion Flange Assy	10	2-4-8051X	3-4-13031-2X	2-4-8051X	3-4-13031-2X	2-4-8051X
5	Slinger – End Yoke	11	41195	41195	41195	41195	41195
6	KIT – Carrier Cover	-	707217X	707217X	707217X	707217X	707217-X
7	Carrier Cover	14	42799-2	42799-2	42799-2	42799-2	42799-2
8	Bolt – Carrier Cover	15	34822	34822	34822	34822	34822
9	Plug – Carrier Cover	16	43181	43181	43181	43181	43181
10	KIT – Differential Bearing	20	706047X	706047X	706047X	706047X	706047X
11	PKG – Differential Bearing Shim	21	708012	708012	708012	708012	708012
12	Bolt – Drive Gear (qty 12)	23	40638	40638	30266	30266	40638
13	Gear – Differential (std)	25	34394	45744	39232	34394	39232
4	Spacer/Shim – Differential Bearing	29	42563	42563	42563	42563	42563
15	Tone Ring	30	42928	42928	42928	42928	42928
16	Lock – Differential Shaft	31	44810	44810	40131-1	44810	40131-1
17	Seal – Hub (Full Float)	34	46004	46004	—	46004	—
18	Spindle Nut (Full Float)	38	43075	—	—	43075	—
19	Spindle Nut (Full Float - LH)	-	43075	—	—	43075	—
20	KIT – Unit Bearing & Seal (Semi Float)	-	—	—	706847X	—	706847X
21	Seal – Inboard Oil	42	—	39246	39246	—	39246
22	Gear – Differential (t/l)	46	—	—	—	—	—
23	Bolt – Axle Shaft (Full Float)	49	45720	45720	—	45720	—
24	Bolt – Axle Shaft (Semi Float)	50	—	—	46426	—	46426
25	KIT – Differential Plate & Disc (t/l)	-	707083X	707083X	707083X	707083X	707083X
26	KIT – RH Rear Axle Shaft	-	—	—	—	—	—
27	KIT – LH Rear Axle Shaft	-	—	—	—	—	—

(See next page for additional bills of material)

Ford Model 60 /248 Rear Axles Variable Parts Listing

Kits & Parts - Use With All Applications							
Description & Item Number (Refer to "Exploded View" at the front of this section)			Bills of Material				
			605841	605842	605843	605859	605920
1	PKG – Diff & Pinion Bearing Shim	-	706838X	706674X	706674X	706838X	706838X
2	PKG – Diff & Pinion Bearing Shim	-	706836X	706672X	706672X	706836X	706836X
3	Baffle – Pinion Bearing	5	30982	30982	30982	30982	—
4	End Yoke/Companion Flange Assy	10	2-4-8051X	2-4-8051X	3-4-13031-2X	2-4-8051X	2-4-8051X
5	Slinger – End Yoke	11	41195	41195	45799	41195	41195
6	KIT – Carrier Cover	-	707217X	707217X	707217X	707217X	707217X
7	Carrier Cover	14	42799-2	42799-2	42799-2	42799-2	42799-2
8	Bolt – Carrier Cover	15	34822	34822	34822	34822	34822
9	Plug – Carrier Cover	16	43181	43181	43181	43181	43181
10	KIT – Differential Bearing	20	706047X	706047X	706047X	706047X	706047X
11	PKG – Differential Bearing Shim	21	708012	708012	708012	708012	708012
12	Bolt – Drive Gear (qty 12)	23	40638	40638	40638	40638	40638
13	Gear – Differential (std)	25	39232	34394	45744	39232	39232
14	Spacer\Shim – Differential Bearing	29	42563	42563	42563	42563	42563
15	Tone Ring	30	42928	42928	42928	42928	42928
16	Lock – Differential Shaft	31	40131-1	44810	44810	40131-1	40131-1
17	Seal – Hub (Full Float)	34	—	46004	46004	—	—
18	Spindle Nut (Full Float)	38	—	43075	43075	—	—
19	Spindle Nut (Full Float - LH)	-	—	43075	43075	—	—
20	KIT – Unit Bearing & Seal (Semi Float)	-	706847X	—	—	706847X	706847X
21	Seal – Inboard Oil	42	39246	—	—	39246	39246
22	Gear – Differential (t/l)	46	—	—	—	—	—
23	Bolt – Axle Shaft (Full Float)	49	—	45720	45720	—	—
24	Bolt – Axle Shaft (Semi Float)	50	46426	—	—	46426	46426
25	KIT – Differential Plate & Disc (t/l)	-	707083X	707083X	707083X	—	—
26	KIT – RH Rear Axle Shaft	-	—	—	—	—	—
27	KIT – LH Rear Axle Shaft	-	—	—	—	—	—
			605921	605933	605934	605935	605947
1	PKG – Diff & Pinion Bearing Shim	-	706838X	706838X	706375X	706674X	707426X
2	PKG – Diff & Pinion Bearing Shim	-	706836X	706836X	706359X	706672X	701012-1X
3	Baffle – Pinion Bearing	5	—	30982	30982	30982	—
4	End Yoke/Companion Flange Assy	10	2-4-8051X	2-4-8051X	2-4-8051X	3-4-13031-2X	3-1-4881X
5	Slinger – End Yoke	11	41195	41195	41195	45799	45799
6	KIT – Carrier Cover	-	707217X	707217-1X	707217-1X	707217-1X	707217-1X
7	Carrier Cover	14	42799-2	42799-2	42799-2	42799-2	42799-2
8	Bolt – Carrier Cover	15	34822	47508-1	47508-1	47508-1	47508-1
9	Plug – Carrier Cover	16	43181	43181	43181	43181	43181
10	KIT – Differential Bearing	20	706047X	706047X	706047X	706047X	706047X
11	PKG – Differential Bearing Shim	21	708012	708012	708012	708012	707425X
12	Bolt – Drive Gear (qty 12)	23	40638	40638	40638	40638	40638
13	Gear – Differential (std)	25	—	39232	34394	45744	39232
14	Spacer\Shim – Differential Bearing	29	42563	42563	42563	42563	47560
15	Tone Ring	30	42928	42928	42928	42928	42928
16	Lock – Differential Shaft	31	40131-1	40131-1	44810	44810	40131-1
17	Seal – Hub (Full Float)	34	—	—	46004	46004	—
18	Spindle Nut (Full Float)	38	—	—	43075	—	—
19	Spindle Nut (Full Float - LH)	-	—	—	43075	—	—
20	KIT – Unit Bearing & Seal (Semi Float)	-	706847X	706847X	—	—	706847-1X
21	Seal – Inboard Oil	42	39246	39246	—	—	46995
22	Gear – Differential (t/l)	46	39256	—	—	—	—
23	Bolt – Axle Shaft (Full Float)	49	—	—	45720	45720	—
24	Bolt – Axle Shaft (Semi Float)	50	46426	46426	—	—	46426
25	KIT – Differential Plate & Disc (t/l)	-	707083X	707083X	707083X	701151X	701151X
26	KIT – RH Rear Axle Shaft	-	—	—	—	—	—
27	KIT – LH Rear Axle Shaft	-	—	—	—	—	—

Ford Model 60 /248 Rear Axles

Variable Parts Listing

Kits & Parts - Use With All Applications							
Description & Item Number (Refer to "Exploded View" at the front of this section)			Bills of Material				
			605948	605949	606017 606029	606049	606050
1	PKG – Diff & Pinion Bearing Shim	-	707431X	707431X	707426X	707431X	707431X
2	PKG – Diff & Pinion Bearing Shim	-	701012-1X	701012-1X	701012-1X	701012-1X	701012-1X
3	Baffle – Pinion Bearing	5	—	—	—	—	—
4	End Yoke/Companion Flange Assy	10	3-1-4881X	3-1-4881X	3-1-4881X	3-1-4881X	3-1-4881X
5	Slinger – End Yoke	11	45799	45799	45799	45799	45799
6	KIT – Carrier Cover	-	707217-1X	707217-1X	707217-1X	707217-1X	707217-1X
7	Carrier Cover	14	42799-2	42799-2	42799-2	42799-2	42799-2
8	Bolt – Carrier Cover	15	47508-1	47508-1	47508-1	47508-1	47508-1
9	Plug – Carrier Cover	16	43181	43181	43181	43181	43181
10	KIT – Differential Bearing	20	706047X	706047X	707489X	707489X	707489X
11	PKG – Differential Bearing Shim	21	701144X	701144X	707425X	701144X	701144X
12	Bolt – Drive Gear (qty 12)	23	40638	40638	40638	40638	40638
13	Gear – Differential (std)	25	45744	45744	39232	45744	45744
14	Spacer/Shim – Differential Bearing	29	47560	47560	47560	47560	47560
15	Tone Ring	30	42928	42928	42928	42928	42928
16	Lock – Differential Shaft	31	44810	44810	40131-1	44810	44810
17	Seal – Hub (Full Float)	34	47507	47507	—	47507	47507
18	Spindle Nut (Full Float)	38	43075	—	—	43075	—
19	Spindle Nut (Full Float - LH)	-	43075	—	—	43075	—
20	KIT – Unit Bearing & Seal (Semi Float)	-	—	—	706847-1X	—	—
21	Seal – Inboard Oil	42	—	—	46995	—	—
22	Gear – Differential (t/l)	46	—	—	—	45745	45745
23	Bolt – Axle Shaft (Full Float)	49	45720	45720	—	45720	45720
24	Bolt – Axle Shaft (Semi Float)	50	—	—	46426	—	—
25	KIT – Differential Plate & Disc (t/l)	-	701151X	701151X	701151X	701151X	701151X
26	KIT – RH Rear Axle Shaft	-	—	—	—	—	—
27	KIT – LH Rear Axle Shaft	-	—	—	—	—	—
			606102	606161	606162		
1	PKG – Diff & Pinion Bearing Shim	-	707426X	707426X	707431X		
2	PKG – Diff & Pinion Bearing Shim	-	701012-1X	701012-1X	701012-1X		
3	Baffle – Pinion Bearing	5	—	—	—		
4	End Yoke/Companion Flange Assy	10	3-1-4881X	3-1-4881X	3-1-4881X		
5	Slinger – End Yoke	11	45799	45799	45799		
6	KIT – Carrier Cover	-	707217-1X	707217-1X	707217-1X		
7	Carrier Cover	14	42799-2	42799-2	42799-2		
8	Bolt – Carrier Cover	15	47508-1	47508-1	47508-1		
9	Plug – Carrier Cover	16	43181	43181	43181		
10	KIT – Differential Bearing	20	707489X	707489X	707489X		
11	PKG – Differential Bearing Shim	21	707425X	707425X	701144X		
12	Bolt – Drive Gear (qty 12)	23	40638	40638	40638		
13	Gear – Differential (std)	25	—	39232	45744		
14	Spacer/Shim – Differential Bearing	29	47560	47560	47560		
15	Tone Ring	30	42928	42928	42928		
16	Lock – Differential Shaft	31	40131-1	40131-1	44810		
17	Seal – Hub (Full Float)	34	—	—	47507		
18	Spindle Nut (Full Float)	38	—	—	43075		
19	Spindle Nut (Full Float - LH)	-	—	—	43075		
20	KIT – Unit Bearing & Seal (Semi Float)	-	706847-1X	706847-1X	—		
21	Seal – Inboard Oil	42	46995	46995	—		
22	Gear – Differential (t/l)	46	39256	39256	45745		
23	Bolt – Axle Shaft (Full Float)	49	—	—	45720		
24	Bolt – Axle Shaft (Semi Float)	50	46426	46426	—		
25	KIT – Differential Plate & Disc (t/l)	-	701151X	701151X	701151X		
26	KIT – RH Rear Axle Shaft	-	—	—	—		
27	KIT – LH Rear Axle Shaft	-	—	—	—		

Ford 1979-1987

Model 61 Rear Axles for

E-250, E-350

F-250, F-350

Ford Model 61 Rear Axles Exploded View

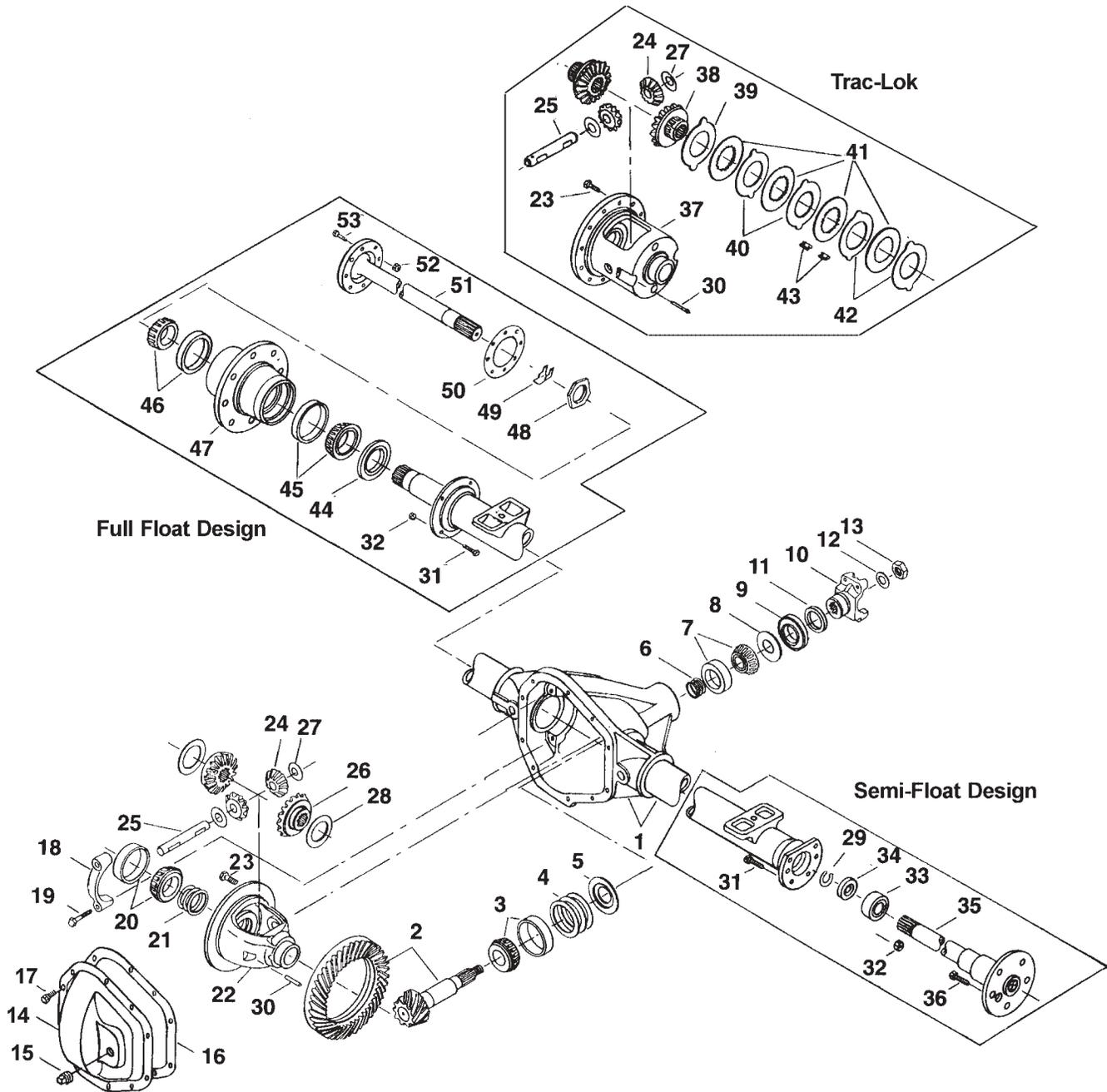

Ford Model 61 Rear Axles Parts Listing

ITEM NO.	PART NUMBER	DESCRIPTION	ITEM NO.	PART NUMBER	DESCRIPTION
1	— ⁽³⁾	Housing – Axle Service	27	34730	Thrustwasher – Diff Pinion (std-t/l)
2	— ⁽¹⁾	Drive Gear & Pinion Assembly	28	34729	Thrustwasher – Diff Gear (std)
3	706046X	KIT – Inner Pinion Bearing	29	39213	C-Clip (only on semi float)
	708020	PKG – Diff & Pinion Bearing Shim (inc items 4, 6, 11, 12, 15, 21)	30	44810	Lock – Differential Shaft
	706359X	PKG – Pinion Bearing Shim (inc items 4, 6, 11, 12, 15)	31	— ⁽³⁾	Bolt – Brake Mounting
4	— ⁽⁴⁾	Inner Pinion Bearing Shims (see shim packages)	32	— ⁽³⁾	Nut – Brake Mounting
5	30982	Baffle – Pinion Bearing	33	565978	KIT – Unit Bearing & Seal (inc items 16, 33, 34)
6	— ⁽⁴⁾	Outer Pinion Bearing Shims (see shim packages)	34	39246	Wheel Bearing Assembly
7	706045X	KIT – Outer Pinion Bearing	35	— ⁽¹⁾	Seal – Inboard Oil
8	42737	Thrustwasher – Bearing	36	— ⁽²⁾	Axle Shaft
9	42449	Seal – Pinion Oil	37	— ⁽⁴⁾	Bolt – Axle Shaft
10	— ⁽²⁾	End Yoke Assembly (inc 11)	38	35803	Case – Differential (t/l)
11	— ⁽²⁾	Slinger – End Yoke		707083X	Gear – Differential (t/l)
12	30275	Washer – Pinion Nut	39	— ⁽⁴⁾	KIT – Differential Plate & Disc (t/l) (inc items 39, 40, 41, 42, 43)
13	30271	Pinion Nut	40	— ⁽⁴⁾	Spacer – Differential Gear (dished)
	— ⁽²⁾	KIT – Carrier Cover (inc 14, 15, 17)	41	— ⁽⁴⁾	Plate – Differential Pressure
14	— ⁽²⁾	Carrier Cover	42	— ⁽⁴⁾	Disc – Differential
15	43180	Plug – Carrier Cover	43	40835	Plate – Differential
16	—	Gasket – Carrier Cover	44	39693	Retainer – Differential Clutch
17	34822	Bolt – Carrier Cover (qty 10)	45	706179X	Seal – Hub
18	— ⁽³⁾	Differential Bearing Cap	46	706074X	Bearing – Inner Wheel
19	48632-1	Bolt – Differential Bearing Cap	47	— ⁽³⁾	Bearing – Outer Wheel
20	706047X	KIT – Differential Bearing	48	— ⁽²⁾	Wheel Hub
21	706374X	PKG – Diff Bearing Shim (inc 15)	49	— ⁽²⁾	Wheel Bearing Retainer
22	— ⁽⁴⁾	Case – Differential (std)	50	39697	Locking Wedge
23	30266	Bolt – Drive Gear (qty 12)	51	— ⁽¹⁾	Gasket
24	34367	Pinion – Differential	52	36526	Axle Shaft
25	30263	Shaft – Differential	53	39694	Lockwasher
26	34394	Gear – Differential (std)		— ⁽²⁾	Bolt – Axle Shaft
				— ⁽²⁾	KIT – RH Rear Axle Shaft
				— ⁽²⁾	KIT – LH Rear Axle Shaft

(1) See "Bill of Material Table" on next page

(2) See "Variable Parts Table" within this section

(3) Contact Vehicle Manufacturer

(4) Not Sold Separately

(5) See Camber/Casting Bushing Table at the back of the Ford section of this catalog

Ford Model 61 Rear Axles

Bill of Material Table

Axle			Axle Kits				Shaft & Joint Assy.	
Bill of Material	Diff. Type	Ratio	Ring Gear & Pinion Kit ⁽⁷⁾	Differential			Right Hand Shaft Assy.	Left Hand Shaft Assy.
				Case Assy. Kit ⁽⁸⁾	Case Kit	Inner Parts Kit		
1979 F-250 4X2 - Full Float								
603925-1	Standard	3.07	706661-11X	706036X	706040X	706043X	35467-3	35467-3
603925-2	Standard	3.31	706661-1X	706036X	706040X	706043X	35467-3	35467-3
1979-80 E-250 - Full Float								
603932-1	Standard	3.31	706396-1X	706036X	706040X	706043X	37560-3	37560-4
603932-3	Standard	3.73	706033-2X	706399X	706400X	706043X	37560-3	37560-4
603932-4	Trac Lok	3.73	706396-4X	707097X	706039X	707084X	37560-3	37560-4
603932-7	Standard	3.07	706661-11X	706036X	706040X	706043X	37560-3	37560-4
603932-8	Standard	3.73	706033-2X	706399X	706400X	706043X	37560-3	37560-4
603932-9	Trac Lok	3.73	706396-4X	707097X	706039X	707084X	37560-3	37560-4
603932-10	Standard	3.54	706033-1X	706399X	706400X	706043X	37560-3	37560-4
603932-11	Trac Lok	3.54	706661-6X	707097X	706039X	707084X	37560-3	37560-4
603932-12	Trac Lok	3.31	706396-1X	708013	708014	707084X	37560-3	37560-4
603932-13	Standard	3.54	706033-1X	706399X	706400X	706043X	37560-3	37560-4
603932-14	Trac Lok	3.54	706661-6X	707097X	706039X	707084X	37560-3	37560-4
1980 F-350 4X2 Chassis - Full Float								
603944-1	Standard	3.73	706033-2X	706399X	706400X	706043X	39260-1	39260-1
603944-3	Standard	4.10	706033-3X	706399X	706400X	706043X	39260-1	39260-1
603944-4	Trac Lok	4.10	706661-9X	707097X	706039X	707084X	39260-1	39260-1
603944-7	Standard	4.56	706661-8X	706399X	706400X	706043X	39260-1	39260-1
1980 F-350 4X2, 4X4 Pick Up - Full Float								
603947-1	Standard	3.54	706033-1X	706399X	706400X	706043X	39260-2	39260-3
603947-2	Standard	4.10	706033-3X	706399X	706400X	706043X	39260-2	39260-3
603947-4	Trac Lok	4.10	706661-9X	707097X	706039X	707084X	39260-2	39260-3
603947-7	Standard	4.56	706661-8X	706399X	706400X	706043X	39260-2	39260-3
603947-8	Standard	3.73	706033-2X	706399X	706400X	706043X	39260-2	39260-3
1980-81 F-250 4X2 - Semi Float								
603946-1	Standard	3.07	706808-3X	706840X	706842X	706844X	70867-1X	70867-2X
603946-2	Trac Lok	3.07	706808-3X	707096X	706843X	707095X	70867-1X	70867-2X
603946-3	Trac Lok	3.00	706808-2X	707096X	706843X	707095X	70867-1X	70867-2X
603946-4	Standard	3.00	706808-2X	706840X	706842X	706844X	70867-1X	70867-2X
1981 E-250 Van - Semi Float								
605030-3	Standard	3.00	706808-2X	706840X	706842X	706844X	70867-3X	70867-4X
605030-4	Trac Lok	3.00	706808-2X	707096X	706843X	707095X	70867-3X	70867-4X
1981 E-250 Van - Full Float								
605064-1	Standard	3.00	706661-10X	706036X	706040X	706043X	37560-3	37560-4
605064-2	Trac Lok	3.00	706808-2X	708013	708014	707084X	37560-3	37560-4
605064-3	Standard	3.33	706660-9X	706399X	706400X	706043X	37560-3	37560-4
605064-4	Standard	3.54	706033-1X	706399X	706400X	706043X	37560-3	37560-4
605064-5	Standard	3.73	706033-2X	706399X	706400X	706043X	37560-3	37560-4
605064-6	Standard	4.10	706033-3X	706399X	706400X	706043X	37560-3	37560-4
605064-7	Trac Lok	4.10	706661-9X	707097X	706039X	707084X	37560-3	37560-4

(7) See Ring Gear & Pinion Kits in XGI Catalog for ratio & tooth combinations.

(8) See Differential Case Assy Kits in XGI Catalog for spline data & ratios.

Ford Model 61 Rear Axles

Bill of Material Table

Axle			Axle Kits				Shaft & Joint Assy.	
Bill of Material	Diff. Type	Ratio	Ring Gear & Pinion Kit ⁽⁷⁾	Differential			Right Hand Shaft Assy.	Left Hand Shaft Assy.
				Case Assy. Kit ⁽⁸⁾	Case Kit	Inner Parts Kit		
1981-83 E-350 DRW Chassis - Full Float								
605022-1	Standard	3.73	706033-2X	706399X	706400X	706043X	39260-4	39260-5
605022-2	Standard	4.10	706033-3X	706399X	706400X	706043X	39260-4	39260-5
605022-3	Trac Lok	4.10	706661-9X	707097X	706039X	707084X	39260-4	39260-5
605022-4	Standard	3.73	706033-2X	706399X	706400X	706043X	39260-4	39260-5
605022-5	Standard	4.10	706033-3X	706399X	706400X	706043X	39260-4	39260-5
605022-6	Trac Lok	4.10	706661-9X	707097X	706039X	707084X	39260-4	39260-5
605022-7	Trac Lok	3.73	706396-4X	707097X	706039X	707084X	39260-4	39260-5
605022-8	Standard	4.56	706661-8X	706399X	706400X	706043X	39260-4	39260-5
605022-10	Standard	3.07	706661-11X	706036X	706040X	706043X	39260-4	39260-5
605022-11	Standard	3.54	706033-1X	706399X	706400X	706043X	39260-4	39260-5
605022-12	Standard	3.07	706661-11X	706036X	706040X	706043X	39260-4	39260-5
605022-13	Standard	3.54	706033-1X	706399X	706400X	706043X	39260-4	39260-5
605022-14	Standard	3.73	706033-2X	706399X	706400X	706043X	39260-4	39260-5
605022-15	Trac Lok	3.73	706396-4X	707097X	706039X	707084X	39260-4	39260-5
605022-16	Standard	4.10	706033-3X	706399X	706400X	706043X	39260-4	39260-5
605022-17	Trac Lok	4.10	706661-9X	707097X	706039X	707084X	39260-4	39260-5
605022-18	Trac Lok	3.54	706661-6X	707097X	706039X	707084X	39260-4	39260-5
1981-83 E-350 School Bus - Full Float								
605056-1	Standard	3.73	706033-2X	706399X	706400X	706043X	39260-4	39260-5
605056-2	Standard	4.10	706033-3X	706399X	706400X	706043X	39260-4	39260-5
605056-3	Trac Lok	4.10	706661-9X	707097X	706039X	707084X	39260-4	39260-5
605056-4	Trac Lok	3.73	706396-4X	707097X	706039X	707084X	39260-4	39260-5
605056-5	Standard	3.07	706661-11X	706036X	706040X	706043X	39260-4	39260-5
605056-6	Standard	3.54	706033-1X	706399X	706400X	706043X	39260-4	39260-5
1981-83 F-350 Chassis - Full Float								
605039-1	Standard	3.73	706033-2X	706399X	706400X	706043X	39260-1	39260-1
605039-2	Standard	4.10	706033-3X	706399X	706400X	706043X	39260-1	39260-1
605039-3	Trac Lok	4.10	706661-9X	707097X	706039X	707084X	39260-1	39260-1
605039-4	Standard	4.56	706661-8X	706399X	706400X	706043X	39260-1	39260-1
605039-5	Standard	3.07	706661-11X	706036X	706040X	706043X	39260-1	39260-1
605039-6	Standard	3.54	706033-1X	706399X	706400X	706043X	39260-1	39260-1
605039-7	Trac Lok	3.54	706661-6X	707097X	706039X	707084X	39260-1	39260-1
1981-83 F-350 - Full Float								
605040-1	Standard	3.54	706033-1X	706399X	706400X	706043X	39260-2	39260-3
605040-2	Standard	4.10	706033-3X	706399X	706400X	706043X	39260-2	39260-3
605040-3	Trac Lok	4.10	706661-9X	707097X	706039X	707084X	39260-2	39260-3
605040-4	Standard	4.56	706661-8X	706399X	706400X	706043X	39260-2	39260-3
605040-5	Standard	3.73	706033-2X	706399X	706400X	706043X	39260-2	39260-3
605040-6	Trac Lok	3.54	706661-6X	707097X	706039X	707084X	39260-2	39260-3
605040-7	Standard	3.07	706661-11X	706036X	706040X	706043X	39260-2	39260-3
1982 F-250 - Semi Float								
605087-3	Trac Lok	3.00	706835-2X	707096X	706843X	707095X	70867-1X	70867-2X
605087-4	Standard	3.00	706835-2X	706840X	706842X	706844X	70867-1X	70867-2X
1982-83 E-250 Van - Semi Float								
605088-3	Standard	3.00	706835-2X	706840X	706842X	706844X	70867-3X	70867-4X
605088-4	Trac Lok	3.00	706835-2X	707096X	706843X	707095X	70867-3X	70867-4X
605088-5	Standard	3.00	706835-2X	706840X	706842X	706844X	70867-3X	70867-4X
605088-6	Trac Lok	3.00	706835-2X	707096X	706843X	707095X	70867-3X	70867-4X

(7) See Ring Gear & Pinion Kits in XGI Catalog for ratio & tooth combinations.

(8) See Differential Case Assy Kits in XGI Catalog for spline data & ratios.

Ford Model 61 Rear Axles

Bill of Material Table

Axle			Axle Kits				Shaft & Joint Assy.	
Bill of Material	Diff. Type	Ratio	Ring Gear & Pinion Kit ⁽⁷⁾	Differential			Right Hand Shaft Assy.	Left Hand Shaft Assy.
				Case Assy. Kit ⁽⁸⁾	Case Kit	Inner Parts Kit		
1983 1/2 E-250 Van - Semi Float								
605178-1	Standard	3.00	706835-2X	706840X	706842X	706844X	70867-3X	70867-4X
605178-2	Trac Lok	3.00	706835-2X	707096X	706843X	707095X	70867-3X	70867-4X
1983 1/2 F-350 Pick-Up - Semi Float								
605154-1	Standard	3.07	706835-3X	706840X	706842X	706844X	70867-11X	70867-12X
1983 1/2 F-350 Chassis - Semi Float								
605156-1	Standard	3.07	706835-3X	706840X	706842X	706844X	70867-13X	70867-14X
1984-85 E-350 Van SRW - Full Float								
605212-1	Standard	3.07	706661-11X	706036X	706040X	706043X	39260-4	39260-5
605212-2	Standard	3.54	706033-1X	706399X	706039X	706043X	39260-4	39260-5
605212-3	Trac Lok	3.54	706661-6X	707097X	706039X	707084X	39260-4	39260-5
605212-4	Standard	3.73	706033-2X	706399X	706400X	706043X	39260-4	39260-5
605212-5	Standard	4.10	706033-3X	706399X	706400X	706043X	39260-4	39260-5
605212-6	Trac Lok	4.10	706661-9X	707097X	706039X	707084X	39260-4	39260-5
1984-85 F-350 - Full Float								
605197-1	Standard	4.10	706033-3X	706399X	706400X	706043X	39260-2	39260-3
605197-2	Trac Lok	4.10	706661-9X	707097X	706039X	707084X	39260-2	39260-3
605197-3	Standard	3.54	706033-1X	706399X	706400X	706043X	39260-2	39260-3
605197-4	Standard	3.73	706033-2X	706399X	706400X	706043X	39260-2	39260-3
605197-5	Trac Lok	3.54	706661-6X	707097X	706039X	707084X	39260-2	39260-3
605197-6	Standard	3.07	706661-11X	706036X	706040X	706043X	39260-2	39260-3
1984-85 F-350 & F-350 Chassis								
605198-1	Trac Lok	3.54	706661-6X	707097X	706039X	707084X	39260-1	39260-1
605198-2	Standard	3.73	706033-2X	706399X	706400X	706043X	39260-1	39260-1
605198-3	Standard	4.10	706033-3X	706399X	706400X	706043X	39260-1	39260-1
605198-4	Trac Lok	4.10	706661-9X	707097X	706039X	707084X	39260-1	39260-1
605198-5	Standard	3.07	706661-11X	706036X	706040X	706043X	39260-1	39260-1
605198-6	Standard	3.54	706033-1X	706399X	706400X	706043X	39260-1	39260-1
1985 F-350 - Full Float								
605244-1	Standard	3.07	706661-11X	706036X	706040X	706043X	39260-2	39260-3
605244-2	Standard	3.54	706033-1X	706399X	706400X	706043X	39260-2	39260-3
605244-3	Trac Lok	3.54	706661-6X	707097X	706039X	707084X	39260-2	39260-3
605244-4	Standard	4.10	706033-3X	706399X	706400X	706043X	39260-2	39260-3
605244-5	Trac Lok	4.10	706661-9X	707097X	706039X	707084X	39260-2	39260-3
605244-6	Standard	4.56	706661-8X	706399X	706400X	706043X	39260-2	39260-3
1985-86 E-350 Van - Full Float								
605252-1	Standard	3.07	706661-11X	706036X	706040X	706043X	39260-4	39260-5
605252-2	Standard	3.54	706033-1X	706399X	706400X	706043X	39260-4	39260-5
605252-3	Trac Lok	3.54	706661-6X	707097X	706039X	707084X	39260-4	39260-5
605252-4	Standard	4.10	706033-3X	706399X	706400X	706043X	39260-4	39260-5
605252-5	Trac Lok	4.10	706661-9X	707097X	706039X	707084X	39260-4	39260-5
1987 E-350 Van - Full Float								
605299-1	Standard	3.07	706661-11X	706036X	706040X	706043X	39260-7	39260-8
605299-2	Standard	3.54	706033-1X	706399X	706400X	706043X	39260-7	39260-8
605299-3	Trac Lok	3.54	706661-6X	707097X	706039X	707084X	39260-7	39260-8
605299-4	Standard	4.10	706033-3X	706399X	706400X	706043X	39260-7	39260-8
605299-5	Trac Lok	4.10	706661-9X	707097X	706039X	707084X	39260-7	39260-8

(7) See Ring Gear & Pinion Kits in XGI Catalog for ratio & tooth combinations.

(8) See Differential Case Assy Kits in XGI Catalog for spline data & ratios.

Ford Model 61 Rear Axles Variable Parts Listing

Kits & Parts - Use With All Applications							
Description & Item Number (Refer to "Exploded View" at the front of this section)			Bills of Material				
			603925	603932 603944	603946	603947	605022
1	End Yoke Assembly (inc 11)	10	3-4-5731X	2-4-5311X	2-4-5311X	2-4-5311X	2-4-8051X
2	Slinger – End Yoke	11	34592	34592	34592	34592	41195
3	KIT – Carrier Cover	-	707106X	707106X	707108X	707106X	707106X
4	Carrier Cover	14	42799-1	42799-1	42799-2	42799-1	42799-1
5	KIT – Unit Bearing & Seal	-	—	—	706747X	—	—
6	Bolt – Axle Shaft	36	—	—	39414	—	—
7	Wheel Bearing Retainer	48	—	—	—	—	39695
8	Locking Wedge	49	—	—	—	—	41373
9	KIT – RH Rear Axle Shaft	-	—	—	706746-1X	—	—
10	KIT – LH Rear Axle Shaft	-	—	—	706746-2X	—	—
			605030	605039 605040 605056 605064	605087	605088	605154
1	End Yoke Assembly (inc 11)	10	2-4-5311X	2-4-5311X	2-4-5311X	2-4-5311X	2-4-5311X
2	Slinger – End Yoke	11	34592	34592	34592	34592	34592
3	KIT – Carrier Cover	-	707108X	707106X	707108X	707108X	707106X
4	Carrier Cover	14	42799-2	42799-1	42799-2	42799-2	42799-1
5	KIT – Unit Bearing & Seal	-	706747X	—	706847X	706847X	706847X
6	Bolt – Axle Shaft	36	39414	—	39414	39414	40751/40752
7	Wheel Bearing Retainer	48	—	39695	—	—	—
8	Locking Wedge	49	—	39696	—	—	—
9	KIT – RH Rear Axle Shaft	-	706746-3X	—	706846-1X	706846-3X	706846-11X
10	KIT – LH Rear Axle Shaft	-	706746-4X	—	706846-2X	706846-4X	706846-12X
			605156	605178	605197 605198 605212 605244 605252	605299	
1	End Yoke Assembly (inc 11)	10	2-4-5311X	2-4-5311X	2-4-8051X	2-4-8051X	
2	Slinger – End Yoke	11	34592	34592	41195	41195	
3	KIT – Carrier Cover	-	707106X	707108X	707106X	707106X	
4	Carrier Cover	14	42799-1	42799-2	42799-1	42799-1	
5	KIT – Unit Bearing & Seal	-	706847X	706847X	—	—	
6	Bolt – Axle Shaft	36	40751/40752	—	—	—	
7	Wheel Bearing Retainer	48	—	—	39695	43075	
8	Locking Wedge	49	—	—	41373	—	
9	KIT – RH Rear Axle Shaft	-	706846-13X	706846-3X	—	—	
10	KIT – LH Rear Axle Shaft	-	706846-14X	706846-4X	—	—	

Ford 1979-1998

Model 70 /267 Rear Axles for

Ambulance

Continental Bakery Chassis

E-250, E-350, E-450

F-350

UPS Chassis

Ford Model 70 /267 Rear Axles Exploded View

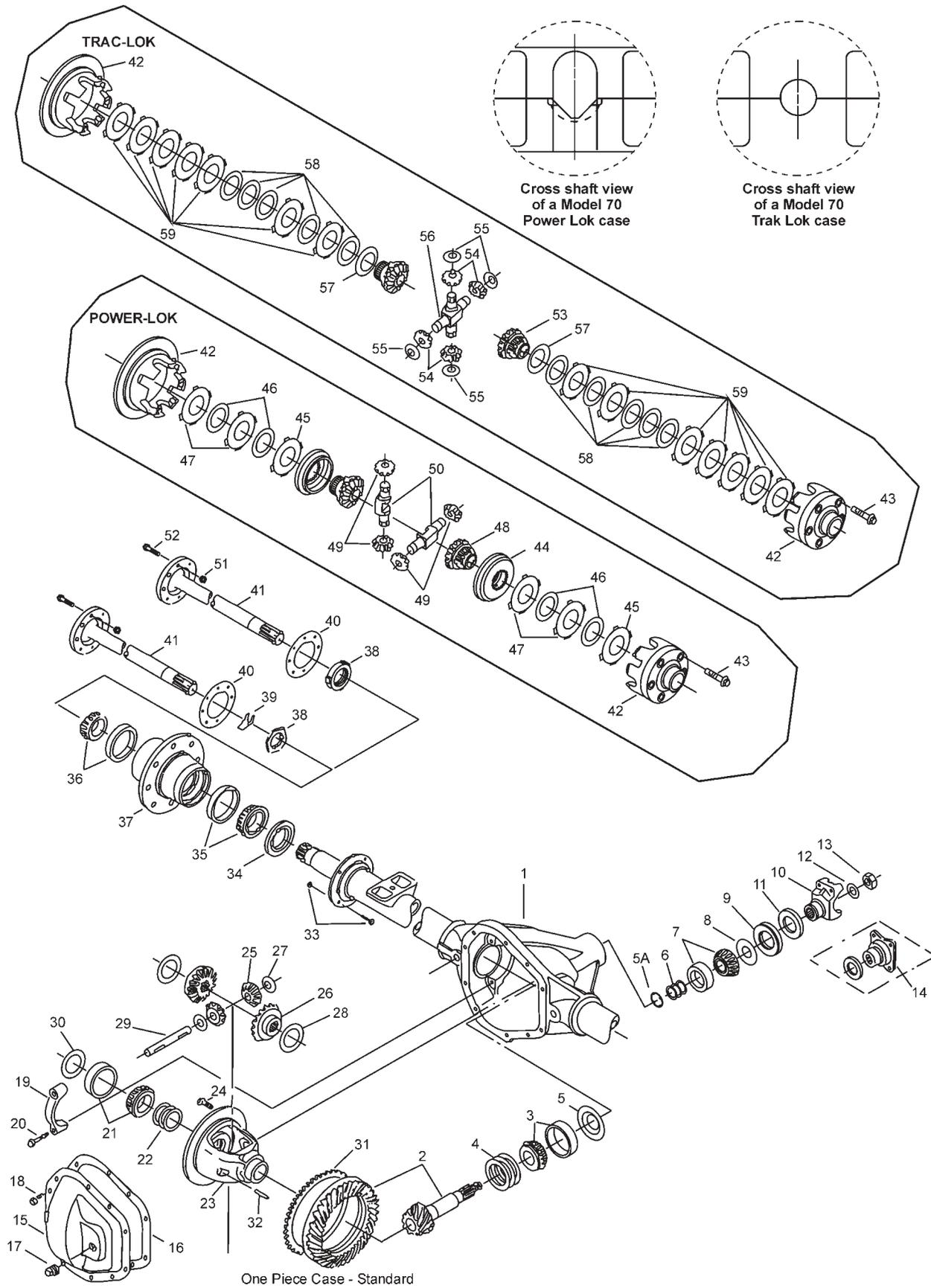

Ford Model 70 /267 Rear Axles

Parts Listing

ITEM NO.	PART NUMBER	DESCRIPTION	ITEM NO.	PART NUMBER	DESCRIPTION
1	— ⁽³⁾	Housing – Axle Service	24	— ⁽²⁾	Bolt – Drive Gear (qty 12)
2	— ⁽¹⁾	Drive Pinion & Gear Assembly	25	35080	Pinion – Differential (std)
3	— ⁽²⁾	KIT – Inner Pinion Bearing	26	— ⁽²⁾	Gear – Differential (std)
4	—	Inner Pinion Shims (see shim packages)	27	35082	Thrustwasher – Diff Pinion (std)
	— ⁽²⁾	PKG – Pinion Bearing Shim (inc items 4, 6, 12, 13, 15, 16)	28	34729	Thrustwasher – Diff Gear (std)
5	— ⁽²⁾	Baffle – Pinion Bearing	29	46640	Shaft – Differential (std)
5A	46176	Spacer – Flat	30	— ⁽²⁾	Spacer – Differential Bearing
6	— ⁽⁴⁾	Outer Pinion Shims (see shim packages)	31	— ⁽²⁾	Tone Ring
	— ⁽²⁾	PKG – Diff & Pinion Bearing Shim (inc items 4, 6, 12, 13, 16, 22)	32	47024	Lock – Differential Shaft
7	706045X	KIT – Outer Pinion Bearing	33	— ⁽³⁾	Nut/Bolt – Brake Mounting
8	42737	Thrustwasher – Bearing	34	— ⁽²⁾	Seal – Hub
9	42449	Seal – Pinion Oil	35	— ⁽²⁾	KIT – Inner Wheel Bearing
10	— ⁽²⁾	End Yoke Assembly (inc 11)	36	— ⁽²⁾	KIT – Outer Wheel Bearing
11	— ⁽²⁾	Slinger – End Yoke	37	— ⁽³⁾	Wheel Hub
12	30275	Washer – Pinion Nut	38	— ⁽²⁾	Spindle Nut / Wheel Bearing Retainer
13	30271	Pinion Nut		— ⁽²⁾	Wheel Bearing Retainer (Left Hand)
14	— ⁽²⁾	Companion Flange Assembly	39	— ⁽²⁾	Locking Wedge
	— ⁽²⁾	KIT – Carrier Cover (inc items 14, 15, 16, 17)	40	39697	Gasket
15	— ⁽²⁾	Carrier Cover	41	— ⁽¹⁾	Shaft – Axle Flange Drive
16	—	Gasket – Carrier Cover	42	— ⁽⁴⁾	Case – Differential
17	— ⁽²⁾	Plug – Carrier Cover	43	41610-1	Bolt – Differential Case
18	— ⁽²⁾	Bolt – Carrier Cover (qty 10)	44	42522	Ring – Differential Gear (p/l)
19	— ⁽³⁾	Differential Bearing Cap		707075X	KIT – Differential Plate & Disc (p/l) (inc items 45, 46, 47)
20	48632-1	Bolt – Differential Bearing Cap	45	— ⁽⁴⁾	Plate – Differential
21	— ⁽²⁾	KIT – Differential Bearing	46	— ⁽⁴⁾	Disc – Differential
22	— ⁽²⁾	PKG – Diff Bearing Shim (inc 16)	47	— ⁽⁴⁾	Plate – Differential
23	— ⁽⁴⁾	Case – Differential (std)	48	— ⁽²⁾	Gear – Differential (p/l)
			49	31040	Pinion – Differential (p/l)
			50	31041	Shaft – Differential (p/l)
			51	— ⁽²⁾	Lockwasher
			52	— ⁽²⁾	Screw – Flange Head

(1) See "Bill of Material Table" on next page

(2) See "Variable Parts Table" within this section

(3) Contact Vehicle Manufacturer

(4) Not Sold Separately

(5) See Camber/Casting Bushing Table at the back of the Ford section of this catalog

Ford Model 70 /267 Rear Axles

Bill of Material Table

Axle			Axle Kits				Shaft & Joint Assy.	
Bill of Material	Diff. Type	Ratio	Ring Gear & Pinion Kit ⁽⁷⁾	Differential			Right Hand Shaft Assy.	Left Hand Shaft Assy.
				Case Assy. Kit ⁽⁸⁾	Case Kit	Inner Parts Kit		
1979 E-350 - 70B								
603938-1	Standard	3.73	706999-3X	706051X	706055X	706058X	36113-8	36113-6
603938-2	Standard	3.73	706999-3X	706051X	706055X	706058X	36113-8	36113-6
603938-3	Standard	4.10	706999-4X	706051X	706055X	706058X	36113-8	36113-6
603938-4	Powr Lok	4.10	706999-4X	706049X	706053X	707074X	36113-8	36113-6
603938-5	Standard	4.56	706999-6X	706052X	706056X	706058X	36113-8	36113-6
603938-6	Standard	4.10	706999-4X	706051X	706055X	706058X	36113-8	36113-6
603938-7	Powr Lok	4.10	706999-4X	706049X	706053X	707074X	36113-8	36113-6
603938-8	Standard	4.56	706999-6X	706052X	706056X	706058X	36113-8	36113-6
1979 F-350 - 70B								
603937-1	Standard	3.73	706999-2X	706051X	706055X	706058X	36113-1	36113-1
603937-2	Standard	3.73	706999-2X	706051X	706055X	706058X	36113-1	36113-1
603937-3	Powr Lok	4.10	706999-4X	706049X	706053X	707074X	36113-1	36113-1
603937-4	Standard	4.56	706999-6X	706052X	706056X	706058X	36113-1	36113-1
603937-5	Standard	4.10	706999-4X	706051X	706055X	706058X	36113-1	36113-1
603937-6	Standard	4.56	706999-6X	706052X	706056X	706058X	36113-1	36113-1
603937-7	Standard	5.13	706999-9X	706052X	706056X	706058X	36113-1	36113-1
603937-8	No Spin	4.10	706999-4X	28286X	706083X	35683	36113-1	36113-1
603937-9	No Spin	4.56	706999-6X	28284X	706084X	35683	36113-1	36113-1
603937-10	Standard	7.17	706999-14X	706052X	706056X	706058X	36113-1	36113-1
603937-11	No Spin	3.73	706999-2X	28286X	706083X	35683	36113-1	36113-1
603937-12	Standard	4.56	706999-6X	706052X	706056X	706058X	36113-1	36113-1
603937-13	Powr Lok	4.56	706999-6X	706050X	706054X	707074X	36113-1	36113-1
603937-14	No Spin	4.56	706999-6X	28284X	706084X	35683	36113-1	36113-1
603935-1	Standard	3.73	706999-2X	706051X	706055X	706058X	36113-1	36113-1
603935-2	Powr Lok	4.10	706999-4X	706049X	706053X	707074X	36113-1	36113-1
603935-3	Powr Lok	3.73	706999-2X	706049X	706053X	707074X	36113-1	36113-1
1979-80 E-350 - 70HD								
603940-1	Standard	4.10	706999-4X	706064X	706068X	706058X	36113-8	36113-6
603940-2	Powr Lok	4.10	706999-4X	707028X ⁽⁹⁾	707029X	707074X	36113-8	36113-6
603940-3	Standard	4.10	706999-4X	706064X	706068X	706058X	36113-8	36113-6
603940-4	Powr Lok	4.10	706999-4X	707028X ⁽⁹⁾	707029X	707074X	36113-8	36113-6
1979-80 E-350 Van - 70B								
603934-1	Standard	3.73	706999-3X	706051X	706055X	706058X	36113-7	36113-8
603934-2	Standard	3.73	706999-3X	706051X	706055X	706058X	36113-7	36113-8
603934-3	Standard	4.10	706999-4X	706051X	706055X	706058X	36113-7	36113-8
603934-4	Powr Lok	4.10	706999-4X	706049X	706053X	707074X	36113-7	36113-8
603934-5	Powr Lok	3.73	706999-3X	706049X	706053X	707074X	36113-7	36113-8
603934-6	Standard	4.56	706999-6X	706052X	706052X	706058X	36113-7	36113-8
603934-7	Standard	4.10	706999-4X	706051X	706055X	706058X	36113-7	36113-8
603934-8	Powr Lok	4.10	706999-4X	706049X	706053X	707074X	36113-7	36113-8
603934-9	Standard	7.17	706999-14X	706052X	706056X	706058X	36113-7	36113-8
603934-10	Standard	4.56	706999-6X	706052X	706056X	706058X	36113-7	36113-8
1979-80 F-350 U-Haul - 70B								
603936-1	Standard	4.10	706999-4X	706051X	706055X	706058X	36113-1	36113-1
603936-2	Standard	4.56	706999-6X	706052X	706056X	706058X	36113-1	36113-1
603936-3	Standard	4.10	706999-4X	706051X	706055X	706058X	36113-1	36113-1

(7) See Ring Gear & Pinion Kits in XGI Catalog for ratio & tooth combinations.

(8) See Differential Case Assy Kits in XGI Catalog for spline data & ratios.

(9) May require 34848-10 & 34848-28 differential bearing spacers.

Ford Model 70 /267 Rear Axles

Bill of Material Table

Axle			Axle Kits				Shaft & Joint Assy.	
Bill of Material	Diff. Type	Ratio	Ring Gear & Pinion Kit ⁽⁷⁾	Differential			Right Hand Shaft Assy.	Left Hand Shaft Assy.
				Case Assy. Kit ⁽⁸⁾	Case Kit	Inner Parts Kit		
1980 Ambulance - 70HD								
603909-1	Standard	3.73	706999-2X	706064X	706068X	706058X	36113-17	36113-17
603909-2	Powr Lok	3.73	706999-2X	707028X ⁽⁹⁾	707029X	707074X	36113-17	36113-17
603909-3	Powr Lok	4.10	706999-4X	707028X ⁽⁹⁾	707029X	707074X	36113-17	36113-17
603909-4	Powr Lok	3.73	706999-2X	707028X ⁽⁹⁾	707029X	707074X	36113-17	36113-17
603909-5	Powr Lok	4.10	706999-4X	707028X ⁽⁹⁾	707029X	707074X	36113-17	36113-17
1980 F-350 - 70B								
603962-1	Standard	3.73	706999-2X	706051X	706055X	706058X	36113-1	36113-1
603962-2	Standard	3.73	706999-2X	706051X	706055X	706058X	36113-1	36113-1
603962-3	Standard	4.10	706999-4X	706051X	706055X	706058X	36113-1	36113-1
603962-4	Powr Lok	4.10	706999-4X	706049X	706053X	707074X	36113-1	36113-1
603962-5	Standard	4.10	706999-4X	706051X	706055X	706058X	36113-1	36113-1
603962-6	Powr Lok	4.10	706999-4X	706049X	706053X	707074X	36113-1	36113-1
603962-7	Standard	4.56	706999-6X	706052X	706056X	706058X	36113-1	36113-1
603962-8	No Spin	4.10	706999-4X	28286X	706083X	35683	36113-1	36113-1
603962-9	Powr Lok	4.56	706999-6X	706050X	706054X	707074X	36113-1	36113-1
603962-10	Standard	7.17	706999-14X	706052X	706056X	706058X	36113-1	36113-1
1980 F-350 Big Dooley - 70HD								
603949-1	Standard	3.73	706999-4X	706064X	706068X	706058X	36113-18	36113-19
603949-2	Powr Lok	4.10	706999-4X	707028X ⁽⁹⁾	707029X	707074X	36113-18	36113-19
603949-5	Standard	4.56	706999-6X	706065X	706069X	706058X	36113-18	36113-19
603949-6	Standard	3.73	706999-2X	706064X	706068X	706058X	36113-18	36113-19
1981-82 E-350 - 70B								
605042-1	Standard	3.73	706999-2X	706051X	706055X	706058X	36113-8	36113-6
605042-2	Standard	4.10	706999-4X	706051X	706055X	706058X	36113-8	36113-6
605042-3	Powr Lok	4.10	706999-4X	706049X	706053X	707074X	36113-8	36113-6
605042-4	Standard	4.56	706999-6X	706052X	706056X	706058X	36113-8	36113-6
605042-5	Powr Lok	3.73	706999-2X	706049X	706053X	707074X	36113-8	36113-6
605042-6	Standard	7.17	706999-14X	706052X	706056X	706058X	36113-8	36113-6
605042-7	Standard	3.73	706999-2X	706051X	706055X	706058X	36113-8	36113-6
605042-8	Standard	4.10	706999-4X	706051X	706055X	706058X	36113-8	36113-6
605042-9	Powr Lok	4.10	706999-4X	706049X	706053X	707074X	36113-8	36113-6
605042-10	Standard	4.56	706999-6X	706052X	706056X	706058X	36113-8	36113-6
605042-11	Powr Lok	3.73	706999-2X	706049X	706053X	707074X	36113-8	36113-6
605042-12	Standard	7.17	706999-14X	706052X	706056X	706058X	36113-8	36113-6
1981-82 E-350 School Bus - 70B								
605057-1	Standard	3.73	706999-2X	706051X	706055X	706058X	36113-8	36113-6
605057-2	Standard	4.10	706999-4X	706051X	706055X	706058X	36113-8	36113-6
605057-3	Powr Lok	4.10	706999-4X	706049X	706053X	707074X	36113-8	36113-6
605057-4	Powr Lok	3.73	706999-2X	706049X	706053X	707074X	36113-8	36113-6
605057-5	Standard	3.73	706999-2X	706051X	706055X	706058X	36113-8	36113-6
605057-6	Standard	4.10	706999-4X	706051X	706055X	706058X	36113-8	36113-6
605057-7	Powr Lok	4.10	706999-4X	706049X	706053X	707074X	36113-8	36113-6
605057-8	Powr Lok	3.73	706999-2X	706049X	706053X	707074X	36113-8	36113-6
1981-82 F-350 DSO Ambulance - 70HD								
605055-1	Standard	3.73	706999-2X	706064X	706068X	706058X	36113-17	36113-17
605055-3	Powr Lok	4.10	706999-4X	707028X ⁽⁹⁾	707029X	707074X	36113-17	36113-17
605055-5	Powr Lok	4.10	706999-4X	707028X ⁽⁹⁾	707029X	707074X	36113-17	36113-17
605055-6	Standard	7.17	706999-14X	706065X	706069X	706058X	36113-17	36113-17

(7) See Ring Gear & Pinion Kits in XGI Catalog for ratio & tooth combinations.

(8) See Differential Case Assy Kits in XGI Catalog for spline data & ratios.

(9) May require 34848-10 & 34848-28 differential bearing spacers.

Ford Model 70 /267 Rear Axles

Bill of Material Table

Axle			Axle Kits				Shaft & Joint Assy.	
Bill of Material	Diff. Type	Ratio	Ring Gear & Pinion Kit ⁽⁷⁾	Differential			Right Hand Shaft Assy.	Left Hand Shaft Assy.
				Case Assy. Kit ⁽⁸⁾	Case Kit	Inner Parts Kit		
1981-83 F-350 DSO Dual Wheel - 70B								
605038-1	Standard	3.73	706999-2X	706051X	706055X	706058X	36113-1	36113-1
605038-2	Standard	4.10	706999-4X	706051X	706055X	706058X	36113-1	36113-1
605038-3	Powr Lok	4.10	706999-4X	706049X	706053X	707074X	36113-1	36113-1
605038-4	Standard	4.56	706999-6X	706052X	706056X	706058X	36113-1	36113-1
605038-5	Standard	7.17	706999-14X	706052X	706056X	706058X	36113-1	36113-1
605038-6	Powr Lok	4.10	706999-4X	706049X	706053X	707074X	36113-1	36113-1
605038-7	Powr Lok	4.56	706999-6X	706050X	706054X	707074X	36113-1	36113-1
605038-8	Powr Lok	7.17	706999-14X	706050X	706054X	707074X	36113-1	36113-1
605038-10	Powr Lok	3.54	706999-1X	706049X	706053X	707074X	36113-1	36113-1
605038-11	No Spin	7.17	706999-14X	28284X	706084X	35683	36113-1	36113-1
605038-12	Standard	3.73	706999-2X	706051X	706055X	706058X	36113-1	36113-1
605038-13	Standard	4.10	706999-4X	706051X	706055X	706058X	36113-1	36113-1
605038-14	Powr Lok	4.10	706999-4X	706049X	706053X	707074X	36113-1	36113-1
605038-15	Powr Lok	4.10	706999-4X	706049X	706053X	707074X	36113-1	36113-1
605038-16	Standard	7.17	706999-14X	706052X	706056X	706058X	36113-1	36113-1
605038-17	No Spin	4.10	706999-4X	706049X	706053X	707074X	36113-1	36113-1
605038-18	Powr Lok	4.56	706999-6X	706050X	706054X	707074X	36113-1	36113-1
605038-19	Powr Lok	7.17	706999-14X	706050X	706054X	707074X	36113-1	36113-1
605038-20	Standard	3.54	706999-1X	706051X	706055X	706058X	36113-1	36113-1
605038-22	No Spin	7.17	706999-14X	28284X	706084X	35683	36113-1	36113-1
1981-83 F-350 Heavy Duty Chassis - 70HD								
605044-1	Standard	4.10	706999-4X	706064X	706068X	706058X	36113-1	36113-1
605044-2	Powr Lok	4.10	706999-4X	707028X ⁽⁹⁾	707029X	707074X	36113-1	36113-1
605044-3	Standard	3.73	706999-2X	706064X	706068X	706058X	36113-1	36113-1
605044-4	Standard	4.56	706999-6X	706065X	706069X	706058X	36113-1	36113-1
605044-5	Powr Lok	4.56	706999-6X	706063X	706730X	707074X	36113-1	36113-1
605044-6	Standard	7.17	706999-14X	706065X	706069X	706058X	36113-1	36113-1
605044-7	No Spin	7.17	706999-14X	26996X	706098X	35683	36113-1	36113-1
605044-8	No Spin	4.10	706999-4X	70716X	706185X	35683	36113-1	36113-1
605044-9	Standard	6.17	706999-12X	706065X	706069X	706058X	36113-1	36113-1
605044-10	Standard	4.10	706999-4X	706064X	706068X	706058X	36113-1	36113-1
605044-11	Powr Lok	4.10	706999-4X	707028X ⁽⁹⁾	707029X	707074X	36113-1	36113-1
605044-12	Standard	3.73	706999-2X	706064X	706068X	706058X	36113-1	36113-1
605044-13	Standard	4.56	706999-6X	706065X	706069X	706058X	36113-1	36113-1
605044-14	Powr Lok	4.56	706999-6X	706063X	706730X	707074X	36113-1	36113-1
605044-15	Standard	7.17	706999-14X	706065X	706069X	706058X	36113-1	36113-1
605044-16	No Spin	7.17	706999-14X	26996X	706098X	35683	36113-1	36113-1
605044-17	No Spin	4.10	706999-4X	70716X	706185X	35683	36113-1	36113-1
605044-18	Standard	6.17	706999-12X	706065X	706069X	706058X	36113-1	36113-1
1981-83 F-350 Dual Wheel - 70HD								
605045-1	Standard	4.10	706999-4X	706064X	706068X	706058X	36113-18	36113-19
605045-2	Powr Lok	4.10	706999-4X	707028X ⁽⁹⁾	707029X	707074X	36113-18	36113-19
605045-3	Standard	4.56	706999-6X	706065X	706069X	706058X	36113-18	36113-19
605045-4	Standard	3.73	706999-2X	706064X	706068X	706058X	36113-18	36113-19
605045-5	Standard	4.10	706999-4X	706064X	706068X	706058X	36113-18	36113-19
605045-6	Powr Lok	4.10	706999-4X	707028X ⁽⁹⁾	707029X	707074X	36113-18	36113-19
605045-7	Standard	4.56	706999-6X	706065X	706069X	706058X	36113-18	36113-19

Continued on next page

(7) See Ring Gear & Pinion Kits in XGI Catalog for ratio & tooth combinations.
 (8) See Differential Case Assy Kits in XGI Catalog for spline data & ratios.
 (9) May require 34848-10 & 34848-28 differential bearing spacers.

Ford Model 70 /267 Rear Axles Bill of Material Table

Axle			Axle Kits				Shaft & Joint Assy.	
Bill of Material	Diff. Type	Ratio	Ring Gear & Pinion Kit ⁽⁷⁾	Differential			Right Hand Shaft Assy.	Left Hand Shaft Assy.
				Case Assy. Kit ⁽⁸⁾	Case Kit	Inner Parts Kit		
1981-83 F-350 Dual Wheel - 70HD (Continued)								
605045-8	Standard	3.73	706999-2X	706064X	706068X	706058X	36113-18	36113-19
605045-9	Standard	3.54	706999-1X	706064X	706068X	706058X	36113-18	36113-19
605045-10	Powr Lok	3.54	706999-1X	706064X	707029X	706058X	36113-18	36113-19
605045-11	Standard	4.56	706999-6X	706065X	706069X	706058X	36113-18	36113-19
605045-12	Standard	4.10	706999-4X	706064X	706068X	706058X	36113-18	36113-19
605045-13	Powr Lok	4.10	706999-4X	707028X ⁽⁹⁾	707029X	707074X	36113-18	36113-19
605045-14	Standard	4.56	706999-6X	706065X	706069X	706058X	36113-18	36113-19
605045-15	Standard	3.73	706999-2X	706064X	706068X	706058X	36113-18	36113-19
605045-16	Standard	4.10	706999-4X	706064X	706068X	706058X	36113-18	36113-19
605045-17	Powr Lok	4.10	706999-4X	707028X ⁽⁹⁾	707029X	707074X	36113-18	36113-19
605045-18	Standard	4.56	706999-6X	706065X	706069X	706058X	36113-18	36113-19
605045-19	Standard	3.73	706999-2X	706064X	706068X	706058X	36113-18	36113-19
605045-22	Standard	4.56	706999-6X	706065X	706069X	706058X	36113-18	36113-19
1981-83 F-350 U-Haul - 70B								
605054-1	Standard	4.10	706999-4X	706051X	706055X	706058X	36113-1	36113-1
605054-3	Standard	4.10	706999-4X	706051X	706055X	706058X	36113-1	36113-1
605054-4	Standard	4.10	706999-4X	706051X	706055X	706058X	36113-1	36113-1
605054-6	Standard	4.10	706999-4X	706051X	706055X	706058X	36113-1	36113-1
1981-85 E-350 DSO - 70HD								
605053-2	Powr Lok	4.10	706999-4X	707028X ⁽⁹⁾	707029X	707074X	36113-8	36113-6
605053-3	Standard	4.10	706999-4X	706064X	706068X	706058X	36113-8	36113-6
605053-4	Powr Lok	4.10	706999-4X	707028X ⁽⁹⁾	707029X	707074X	36113-8	36113-6
605053-5	Standard	3.73	706999-2X	706064X	706068X	706058X	36113-8	36113-6
605053-6	Powr Lok	3.73	706999-2X	707028X ⁽⁹⁾	707029X	707074X	36113-8	36113-6
605053-7	Standard	4.10	706999-4X	706064X	706068X	706058X	36113-8	36113-6
605053-8	Powr Lok	4.10	706999-4X	707028X ⁽⁹⁾	707029X	707074X	36113-8	36113-6
605053-9	Standard	4.10	706999-4X	706064X	706068X	706058X	36113-8	36113-6
605053-10	Powr Lok	4.10	706999-4X	707028X ⁽⁹⁾	707029X	707074X	36113-8	36113-6
605053-11	Standard	3.73	706999-2X	706064X	706068X	706058X	36113-8	36113-6
605053-12	Powr Lok	3.73	706999-2X	707028X ⁽⁹⁾	707029X	707074X	36113-8	36113-6
605053-13	Standard	4.10	706999-4X	706064X	706068X	706058X	36113-8	36113-6
605053-14	Powr Lok	4.10	706999-4X	707028X ⁽⁹⁾	707029X	707074X	36113-8	36113-6
605053-15	Standard	3.73	706999-2X	706064X	706068X	706058X	36113-8	36113-6
605053-16	Powr Lok	3.73	706999-2X	707028X ⁽⁹⁾	707029X	707074X	36113-8	36113-6
605053-17	Standard	3.54	706999-1X	706064X	706068X	706058X	36113-8	36113-6
605053-18	Powr Lok	3.54	706999-1X	707028X ⁽⁹⁾	707029X	707074X	36113-8	36113-6
605053-19	Standard	4.10	706999-4X	706064X	706068X	706058X	36113-8	36113-6
605053-20	Powr Lok	4.10	706999-4X	707028X ⁽⁹⁾	707029X	707074X	36113-8	36113-6
605053-22	Powr Lok	3.73	706999-2X	707028X ⁽⁹⁾	707029X	707074X	36113-8	36113-6
1981 1/2-83 E-350 DSO - 70B								
605080-2	Standard	4.10	706999-4X	706051X	706055X	706058X	36113-8	36113-6
605080-4	Standard	4.56	706999-6X	706052X	706056X	706058X	36113-8	36113-6
1981 1/2-83 E-350 DSO - 70HD								
605101-1	Standard	4.10	706999-4X	706064X	706068X	706058X	36113-8	36113-6
605101-2	Powr Lok	4.10	706999-4X	707028X ⁽⁹⁾	707029X	707074X	36113-8	36113-6
605101-3	Standard	4.10	706999-4X	706064X	706068X	706058X	36113-8	36113-6
605101-4	Powr Lok	4.10	706999-4X	707028X ⁽⁹⁾	707029X	707074X	36113-8	36113-6

(7) See Ring Gear & Pinion Kits in XGI Catalog for ratio & tooth combinations.

(8) See Differential Case Assy Kits in XGI Catalog for spline data & ratios.

(9) May require 34848-10 & 34848-28 differential bearing spacers.

Ford Model 70 /267 Rear Axles

Bill of Material Table

Axle			Axle Kits				Shaft & Joint Assy.	
Bill of Material	Diff. Type	Ratio	Ring Gear & Pinion Kit ⁽⁷⁾	Differential			Right Hand Shaft Assy.	Left Hand Shaft Assy.
				Case Assy. Kit ⁽⁸⁾	Case Kit	Inner Parts Kit		
1982 1/2-83 E-350 DSO - 70B								
605139-1	Standard	3.73	706999-2X	706051X	706055X	706058X	36113-1	36113-1
1982 1/2-83 E-350 DSO - 70U								
605114-1	Standard	3.73	706998-2X	706051X	706055X	706058X	36113-8	36113-6
605114-2	Standard	4.10	706998-3X	706051X	706055X	706058X	36113-8	36113-6
605114-3	Powr Lok	4.10	706998-3X	706049X	706053X	707074X	36113-8	36113-6
605114-4	Standard	4.56	706998-4X	706052X	706056X	706058X	36113-8	36113-6
605114-5	Powr Lok	3.73	706998-2X	706049X	706053X	707074X	36113-8	36113-6
605114-6	Standard	3.54	706998-1X	706051X	706055X	706058X	36113-8	36113-6
605114-7	Standard	7.17	706998-9X	706052X	706056X	706058X	36113-8	36113-6
605114-8	Standard	3.73	706998-2X	706051X	706055X	706058X	36113-8	36113-6
605114-9	Standard	4.10	706998-3X	706051X	706055X	706058X	36113-8	36113-6
605114-10	Powr Lok	4.10	706998-3X	706049X	706053X	707074X	36113-8	36113-6
605114-11	Standard	4.56	706998-4X	706052X	706056X	706058X	36113-8	36113-6
605114-12	Powr Lok	3.73	706998-2X	706049X	706053X	707074X	36113-8	36113-6
605114-13	Standard	3.54	706998-1X	706051X	706055X	706058X	36113-8	36113-6
605114-14	Standard	7.17	706998-9X	706052X	706056X	706058X	36113-8	36113-6
605114-15	Standard	3.54	706998-1X	706051X	706055X	706058X	36113-8	36113-6
605114-16	Powr Lok	3.73	706998-2X	706049X	706053X	707074X	36113-8	36113-6
605114-17	Standard	4.10	706998-3X	706051X	706055X	706058X	36113-8	36113-6
605114-18	Powr Lok	4.10	706998-3X	706049X	706053X	707074X	36113-8	36113-6
605114-19	Standard	3.54	706998-1X	706051X	706055X	706058X	36113-8	36113-6
605114-26	Standard	7.17	706998-9X	706052X	706056X	706058X	36113-8	36113-6
1982 1/2-83 F-350 DSO Wide Track - 70HD								
605118-1	Standard	3.73	706999-2X	706064X	706068X	706058X	36113-17	36113-17
605118-2	Powr Lok	4.10	706999-4X	707028X ⁽⁹⁾	707029X	707074X	36113-17	36113-17
605118-3	Standard	3.54	706999-1X	706064X	706068X	706058X	36113-17	36113-17
605118-4	Standard	4.10	706999-4X	706064X	706068X	706058X	36113-17	36113-17
605118-5	Standard	3.73	706999-2X	706064X	706068X	706058X	36113-17	36113-17
605118-6	Powr Lok	4.10	706999-4X	707028X ⁽⁹⁾	707029X	707074X	36113-17	36113-17
605118-7	Standard	3.54	706999-1X	706064X	706068X	706058X	36113-17	36113-17
605118-8	Standard	4.10	706999-4X	706064X	706068X	706058X	36113-17	36113-17
1982 1/2-83 1/2 F-350 DSO Ambulance - 70HD								
605138-1	Powr Lok	4.10	706999-4X	707028X ⁽⁹⁾	707029X	707074X	36113-17	36113-17
605138-2	Standard	3.73	706999-2X	706064X	706068X	706058X	36113-17	36113-17
605138-3	Powr Lok	3.73	706999-2X	707028X ⁽⁹⁾	707029X	707074X	36113-17	36113-17
605138-4	Powr Lok	4.10	706999-4X	707028X ⁽⁹⁾	707029X	707074X	36113-17	36113-17
605138-5	Standard	3.73	706999-2X	706064X	706068X	706058X	36113-17	36113-17
605138-6	Powr Lok	3.73	706999-2X	707028X ⁽⁹⁾	707029X	707074X	36113-17	36113-17
1983 E-350 DSO - 70U								
605115-1	Standard	3.73	706998-2X	706051X	706055X	706058X	36113-8	36113-6
605115-2	Standard	4.10	706998-3X	706051X	706055X	706058X	36113-8	36113-6
605115-3	Powr Lok	4.10	706998-3X	706049X	706053X	707074X	36113-8	36113-6
605115-4	Powr Lok	3.73	706998-2X	706049X	706053X	707074X	36113-8	36113-6
605115-5	Standard	3.54	706998-1X	706051X	706055X	706058X	36113-8	36113-6
605115-6	Standard	3.73	706998-2X	706051X	706055X	706058X	36113-8	36113-6
605115-7	Standard	4.10	706998-3X	706051X	706055X	706058X	36113-8	36113-6
605115-8	Powr Lok	4.10	706998-3X	706049X	706053X	707074X	36113-8	36113-6
605115-9	Powr Lok	3.73	706998-2X	706049X	706053X	707074X	36113-8	36113-6
605115-10	Standard	3.54	706998-1X	706051X	706055X	706058X	36113-8	36113-6

(7) See Ring Gear & Pinion Kits in XGI Catalog for ratio & tooth combinations.
(8) See Differential Case Assy Kits in XGI Catalog for spline data & ratios.
(9) May require 34848-10 & 34848-28 differential bearing spacers.

Ford Model 70 /267 Rear Axles

Bill of Material Table

Axle			Axle Kits				Shaft & Joint Assy.	
Bill of Material	Diff. Type	Ratio	Ring Gear & Pinion Kit ⁽⁷⁾	Differential			Right Hand Shaft Assy.	Left Hand Shaft Assy.
				Case Assy. Kit ⁽⁸⁾	Case Kit	Inner Parts Kit		
1983 1/2 E-350 DSO - 70B								
605143-1	Standard	4.10	706999-4X	706051X	706055X	706058X	36113-8	36113-6
605143-2	Standard	4.56	706999-6X	706052X	706056X	706058X	36113-8	36113-6
1983 1/2 F-350 - 70U								
605175-1	Standard	3.54	706998-1X	706051X	706055X	706058X	36113-1	36113-1
605175-2	Powr Lok	3.54	706998-1X	706049X	706053X	707074X	36113-1	36113-1
605175-3	Standard	4.10	706998-3X	706051X	706055X	706058X	36113-1	36113-1
605175-4	Powr Lok	4.10	706998-3X	706049X	706053X	707074X	36113-1	36113-1
605175-5	Standard	3.54	706998-1X	706051X	706055X	706058X	36113-1	36113-1
605175-6	Powr Lok	3.54	706998-1X	706049X	706053X	707074X	36113-1	36113-1
605175-7	Standard	4.10	706998-3X	706051X	706055X	706058X	36113-1	36113-1
605175-8	Powr Lok	4.10	706998-3X	706049X	706053X	707074X	36113-1	36113-1
605175-9	Standard	3.54	706998-1X	706051X	706055X	706058X	36113-1	36113-1
605175-10	Powr Lok	3.54	706998-1X	706049X	706053X	707074X	36113-1	36113-1
605175-11	Standard	4.10	706998-3X	706051X	706055X	706058X	36113-1	36113-1
605175-12	Powr Lok	4.10	706998-3X	706049X	706053X	707074X	36113-1	36113-1
605175-13	Standard	4.56	706998-4X	706052X	706056X	706058X	36113-1	36113-1
605175-14	Standard	3.54	706998-1X	706051X	706055X	706058X	36113-1	36113-1
605175-15	Powr Lok	3.54	706998-1X	706049X	706053X	707074X	36113-1	36113-1
605175-16	Standard	4.10	706998-3X	706051X	706055X	706058X	36113-1	36113-1
605175-17	Powr Lok	4.10	706998-3X	706049X	706053X	707074X	36113-1	36113-1
605175-18	Standard	7.17	706999-15X	706052X	706056X	706058X	36113-1	36113-1
605175-19	Standard	4.56	706998-4X	706052X	706056X	706058X	36113-1	36113-1
605175-23	No Spin	7.17	706999-15X	28284X	706084X	35683	36113-1	36113-1
1983 1/2 F-350 U-Haul - 70U								
605206-1	Standard	4.10	706998-3X	706051X	706055X	706058X	36113-1	36113-1
605206-2	Standard	4.56	706998-4X	706052X	706056X	706058X	36113-1	36113-1
605206-3	Standard	4.10	706998-3X	706051X	706055X	706058X	36113-1	36113-1
1983 1/2-85 F-350 Heavy Duty Chassis - 70HD								
605176-1	Standard	4.10	706999-4X	706064X	706068X	706058X	36113-1	36113-1
605176-2	Standard	4.56	706999-6X	706065X	706069X	706058X	36113-1	36113-1
605176-3	Standard	4.10	706999-4X	706064X	706068X	706058X	36113-1	36113-1
605176-4	Standard	4.56	706999-6X	706065X	706069X	706058X	36113-1	36113-1
605176-5	Standard	4.10	706999-4X	706064X	706068X	706058X	36113-1	36113-1
605176-6	Standard	3.73	706999-2X	706064X	706068X	706058X	36113-1	36113-1
605176-7	Powr Lok	4.10	706999-4X	707028X ⁽⁹⁾	707029X	707074X	36113-1	36113-1
605176-8	Powr Lok	4.56	706999-6X	706063X	706067X	707074X	36113-1	36113-1
605176-9	Standard	4.10	706999-4X	706064X	706068X	706058X	36113-1	36113-1
605176-10	Standard	3.54	706999-1X	706064X	706068X	706058X	36113-1	36113-1
605176-11	Powr Lok	4.10	706999-4X	707028X ⁽⁹⁾	707029X	707074X	36113-1	36113-1
605176-12	Standard	4.56	706999-6X	706065X	706069X	706058X	36113-1	36113-1
605176-13	Powr Lok	4.56	706999-6X	706063X	706067X	707074X	36113-1	36113-1
605176-14	Standard	6.17	706999-12X	706065X	706069X	706058X	36113-1	36113-1
605176-15	Powr Lok	3.54	706999-1X	707028X	707029X	707074X	36113-1	36113-1
605176-16	Powr Lok	4.10	706999-4X	707028X	707029X	707074X	36113-1	36113-1
605176-17	Powr Lok	3.54	706999-1X	707028X	707029X	707074X	36113-1	36113-1
605176-18	Standard	4.56	706999-6X	706065X	706069X	706058X	36113-1	36113-1

(7) See Ring Gear & Pinion Kits in XGI Catalog for ratio & tooth combinations.

(8) See Differential Case Assy Kits in XGI Catalog for spline data & ratios.

(9) May require 34848-10 & 34848-28 differential bearing spacers.

Ford Model 70 /267 Rear Axles

Bill of Material Table

Axle			Axle Kits				Shaft & Joint Assy.	
Bill of Material	Diff. Type	Ratio	Ring Gear & Pinion Kit ⁽⁷⁾	Differential			Right Hand Shaft Assy.	Left Hand Shaft Assy.
				Case Assy. Kit ⁽⁸⁾	Case Kit	Inner Parts Kit		
1983 1/2-85 F-350 - 70U								
605205-1	Standard	4.10	706998-3X	706051X	706055X	706058X	36113-23	36113-22
605205-2	Powr Lok	4.10	706998-3X	706049X	706053X	707074X	36113-23	36113-22
605205-3	Standard	3.54	706998-1X	706051X	706055X	706058X	36113-23	36113-22
605205-4	Powr Lok	3.54	706998-1X	706049X	706053X	707074X	36113-23	36113-22
605205-5	Standard	3.54	706998-1X	706051X	706055X	706058X	36113-23	36113-22
605205-6	Powr Lok	3.54	706998-1X	706049X	706053X	707074X	36113-23	36113-22
605205-7	Standard	4.10	706998-3X	706051X	706055X	706058X	36113-23	36113-22
605205-8	Powr Lok	4.10	706998-3X	706049X	706053X	707074X	36113-23	36113-22
605205-9	Standard	4.56	706998-4X	706052X	706056X	706058X	36113-23	36113-22
605205-10	No Spin	4.56	706998-4X	28284X	706631X	35683	36113-23	36113-22
1983 1/2-85 F-350 Pick-Up - 70U								
605204-1	Standard	4.10	706998-3X	706051X	706055X	707074X	36113-7	36113-21
605204-2	Powr Lok	4.10	706998-3X	706049X	706053X	707074X	36113-7	36113-21
605204-3	Standard	3.54	706998-1X	706051X	706055X	706058X	36113-7	36113-21
605204-4	Powr Lok	3.54	706998-1X	706049X	706053X	707074X	36113-7	36113-21
605204-5	Standard	3.54	706998-1X	706051X	706055X	706058X	36113-7	36113-21
605204-6	Powr Lok	3.54	706998-1X	706049X	706053X	707074X	36113-7	36113-21
605204-7	Standard	4.10	706998-3X	706051X	706055X	706058X	36113-7	36113-21
605204-8	Powr Lok	4.10	706998-3X	706049X	706053X	707074X	36113-7	36113-21
1983 1/2-85 F-350 DSO Ambulance - 70HD								
605207-1	Powr Lok	4.10	706999-4X	707028X ⁽⁹⁾	707029X	707074X	36113-17	36113-17
605207-2	Standard	3.73	706999-2X	706064X	706068X	706058X	36113-17	36113-17
605207-3	Powr Lok	3.73	706999-2X	707028X ⁽⁹⁾	707029X	707074X	36113-17	36113-17
605207-4	Standard	4.10	706999-4X	706064X	706068X	706058X	36113-17	36113-17
605207-5	Standard	3.54	706999-1X	706064X	706068X	706058X	36113-17	36113-17
605207-6	Powr Lok	4.10	706999-4X	707028X ⁽⁹⁾	707029X	707074X	36113-17	36113-17
605207-7	Standard	3.73	706999-2X	706064X	706068X	706058X	36113-17	36113-17
605207-8	Powr Lok	3.73	706999-2X	707028X ⁽⁹⁾	707029X	707074X	36113-17	36113-17
605207-9	Standard	4.10	706999-4X	706064X	706068X	706058X	36113-17	36113-17
605207-10	Standard	3.54	706999-1X	706064X	706068X	706058X	36113-17	36113-17
605207-11	Powr Lok	4.10	706999-4X	707028X ⁽⁹⁾	707029X	707074X	36113-17	36113-17
605207-12	Standard	3.73	706999-2X	706064X	706068X	706058X	36113-17	36113-17
605207-13	Powr Lok	3.73	706999-2X	707028X ⁽⁹⁾	707029X	707074X	36113-17	36113-17
605207-14	Standard	4.10	706999-4X	706064X	706068X	706058X	36113-17	36113-17
605207-15	Standard	3.54	706999-1X	706064X	706068X	706058X	36113-17	36113-17
1984-85 E-350 - 70U								
605213-1	Standard	3.54	706998-1X	706051X	706055X	706058X	36113-8	36113-6
605213-2	Powr Lok	3.54	706998-1X	706049X	706053X	707074X	36113-8	36113-6
605213-3	Powr Lok	3.73	706998-2X	706049X	706053X	707074X	36113-8	36113-6
605213-4	Standard	4.10	706998-3X	706051X	706055X	706058X	36113-8	36113-6
605213-5	Powr Lok	4.10	706998-3X	706049X	706053X	707074X	36113-8	36113-6
605213-6	Standard	3.54	706998-1X	706051X	706055X	706058X	36113-8	36113-6
605213-7	Powr Lok	3.54	706998-1X	706049X	706053X	707074X	36113-8	36113-6
605213-8	Powr Lok	3.73	706998-2X	706049X	706053X	707074X	36113-8	36113-6
605213-9	Standard	4.10	706998-3X	706051X	706055X	706058X	36113-8	36113-6
605213-10	Powr Lok	4.10	706998-3X	706049X	706053X	707074X	36113-8	36113-6
605213-11	Standard	7.17	706998-9X	706052X	706056X	706058X	36113-8	36113-6
605213-12	Standard	4.56	706998-4X	706052X	706056X	706058X	36113-8	36113-6

(7) See Ring Gear & Pinion Kits in XGI Catalog for ratio & tooth combinations.

(8) See Differential Case Assy Kits in XGI Catalog for spline data & ratios.

(9) May require 34848-10 & 34848-28 differential bearing spacers.

Ford Model 70 /267 Rear Axles

Bill of Material Table

Axle			Axle Kits				Shaft & Joint Assy.	
Bill of Material	Diff. Type	Ratio	Ring Gear & Pinion Kit ⁽⁷⁾	Differential			Right Hand Shaft Assy.	Left Hand Shaft Assy.
				Case Assy. Kit ⁽⁸⁾	Case Kit	Inner Parts Kit		
1984-85 F-350 Big Dooley - 70HD								
605170-1	Standard	4.10	706999-4X	706064X	706068X	706058X	36113-18	36113-19
605170-2	Powr Lok	4.10	706999-4X	707028X ⁽⁹⁾	707029X	707074X	36113-18	36113-19
605170-3	Standard	4.56	706999-6X	706065X	706069X	706058X	36113-18	36113-19
605170-5	Standard	3.54	706999-1X	706064X	706068X	706058X	36113-18	36113-19
605170-6	Powr Lok	3.54	706999-1X	707028X ⁽⁹⁾	707029X	707074X	36113-18	36113-19
605170-7	Standard	4.10	706999-4X	706064X	706068X	706058X	36113-18	36113-19
605170-8	Powr Lok	4.10	706999-4X	707028X ⁽⁹⁾	707029X	707074X	36113-18	36113-19
605170-9	Standard	4.56	706999-6X	706065X	706069X	706058X	36113-18	36113-19
605170-11	Standard	3.54	706999-1X	706064X	706068X	706058X	36113-18	36113-19
605170-12	Powr Lok	3.54	706999-1X	707028X ⁽⁹⁾	707029X	707074X	36113-18	36113-19
605170-13	Standard	3.54	706999-1X	706064X	706068X	706058X	36113-18	36113-19
605170-14	Powr Lok	3.54	706999-1X	707028X ⁽⁹⁾	707029X	707074X	36113-18	36113-19
605170-15	Standard	4.10	706999-4X	706064X	706068X	706058X	36113-18	36113-19
605170-16	Powr Lok	4.10	706999-4X	707028X ⁽⁹⁾	707029X	707074X	36113-18	36113-19
605170-17	Standard	3.54	706999-1X	706064X	706068X	706058X	36113-18	36113-19
605170-18	Powr Lok	3.54	706999-1X	707028X ⁽⁹⁾	707029X	707074X	36113-18	36113-19
605170-19	Standard	4.10	706999-4X	706064X	706068X	706058X	36113-18	36113-19
605170-20	Powr Lok	4.10	706999-4X	707028X ⁽⁹⁾	707029X	707074X	36113-18	36113-19
1984-85 F-350 - 70U								
605208-1	Standard	3.54	706998-1X	706051X	706055X	706058X	36113-1	36113-1
605208-2	Powr Lok	3.54	706998-1X	706049X	706053X	707074X	36113-1	36113-1
605208-3	Standard	4.10	706998-3X	706051X	706055X	706058X	36113-1	36113-1
605208-4	Powr Lok	4.10	706998-3X	706049X	706053X	707074X	36113-1	36113-1
605208-5	Standard	3.54	706998-1X	706051X	706055X	706058X	36113-1	36113-1
605208-6	Powr Lok	3.54	706998-1X	706049X	706053X	707074X	36113-1	36113-1
605208-7	Standard	4.10	706998-3X	706051X	706055X	706058X	36113-1	36113-1
605208-8	Powr Lok	4.10	706998-3X	706049X	706053X	707074X	36113-1	36113-1
605208-9	Powr Lok	7.17	706998-10X	706050X	706054X	707074X	36113-1	36113-1
605208-10	Standard	7.17	706998-9X	706052X	706056X	706058X	36113-1	36113-1
605208-11	Standard	4.56	706998-4X	706052X	706056X	706058X	36113-1	36113-1
1985 F-350 - 70U								
605246-1	Standard	3.54	706998-1X	706051X	706055X	706058X	36113-7	36113-21
605246-2	Standard	4.10	706998-3X	706051X	706055X	706058X	36113-7	36113-21
605246-3	Powr Lok	4.10	706998-3X	707026X	706053X	707074X	36113-7	36113-21
605246-4	Standard	4.56	706998-4X	706052X	706056X	706058X	36113-7	36113-21
605247-1	Standard	3.54	706998-1X	706051X	706055X	706058X	36113-23	36113-22
605247-2	Powr Lok	3.54	706998-1X	707026X	706053X	707074X	36113-23	36113-22
605247-3	Standard	4.10	706998-3X	706051X	706055X	706058X	36113-23	36113-22
605247-4	Powr Lok	4.10	706998-3X	707026X	706053X	707074X	36113-23	36113-22
605248-1	Standard	3.54	706998-1X	706051X	706055X	706058X	36113-1	36113-1
605248-2	Powr Lok	3.54	706998-1X	707026X	706053X	707074X	36113-1	36113-1
605248-3	Standard	4.10	706998-3X	706051X	706055X	706058X	36113-1	36113-1
605248-4	Powr Lok	4.10	706998-3X	707026X	706053X	707074X	36113-1	36113-1
605248-5	Standard	4.56	706998-4X	706052X	706056X	706058X	36113-1	36113-1
605248-6	Standard	4.56	706998-4X	706052X	706056X	706058X	36113-1	36113-1
605248-7	Standard	7.17	706998-9X	706052X	706056X	706058X	36113-1	36113-1

(7) See Ring Gear & Pinion Kits in XGI Catalog for ratio & tooth combinations.

(8) See Differential Case Assy Kits in XGI Catalog for spline data & ratios.

(9) May require 34848-10 & 34848-28 differential bearing spacers.

Ford Model 70 /267 Rear Axles

Bill of Material Table

Axle			Axle Kits				Shaft & Joint Assy.	
Bill of Material	Diff. Type	Ratio	Ring Gear & Pinion Kit ⁽⁷⁾	Differential			Right Hand Shaft Assy.	Left Hand Shaft Assy.
				Case Assy. Kit ⁽⁸⁾	Case Kit	Inner Parts Kit		
1985 F-350 Big Dooley - 70HD								
605250-1	Standard	3.54	706999-1X	706064X	706068X	706058X	36113-18	36113-19
605250-2	Standard	4.10	706999-4X	706064X	706068X	706058X	36113-18	36113-19
605250-3	Powr Lok	4.10	706999-4X	707028X ⁽⁹⁾	707029X	707074X	36113-18	36113-19
1985 F-350 Heavy Duty Chassis - 70HD								
605249-1	Standard	4.10	706999-4X	706064X	706068X	706058X	36113-1	36113-1
605249-2	Standard	3.54	706999-1X	706064X	706068X	706058X	36113-1	36113-1
605249-3	Powr Lok	4.56	706999-6X	706063X	706730X	707074X	36113-1	36113-1
605249-4	Powr Lok	4.10	706999-4X	707028X ⁽⁹⁾	707029X	707074X	36113-1	36113-1
605249-5	No Spin	4.56	706999-6X	26996X	706098X	35683	36113-1	36113-1
605249-6	Standard	6.17	706999-12X	706065X	706069X	706058X	36113-1	36113-1
605249-7	Standard	4.56	706999-6X	706065X	706069X	706058X	36113-1	36113-1
1985-86 E-350 - 70U								
605253-1	Standard	3.54	706998-1X	706051X	706055X	706058X	36113-8	36113-6
605253-2	Standard	4.10	706998-3X	706051X	706055X	706058X	36113-8	36113-6
605253-3	Powr Lok	4.10	706998-3X	707026X	706053X	707074X	36113-8	36113-6
605253-4	Standard	4.56	706998-4X	706052X	706056X	706058X	36113-8	36113-6
605253-5	Standard	5.13	706998-6X	706052X	706056X	706058X	36113-8	36113-6
1985-87 F-350 - DSO Ambulance - 70HD								
605255-1	Standard	3.54	706999-1X	706064X	706068X	706058X	36113-17	36113-17
605255-2	Powr Lok	3.54	706999-1X	707028X ⁽⁹⁾	707029X	707074X	36113-17	36113-17
605255-3	Standard	3.73	706999-2X	706064X	706068X	706058X	36113-17	36113-17
605255-4	Powr Lok	3.73	706999-2X	707028X ⁽⁹⁾	707029X	707074X	36113-17	36113-17
605255-5	Standard	4.10	706999-4X	706064X	706068X	706058X	36113-17	36113-17
605255-6	Powr Lok	4.10	706999-4X	707028X ⁽⁹⁾	707029X	707074X	36113-17	36113-17
1987-88 E-350 - DRW - 70U								
605300-1	Standard	3.54	706998-1X	706051X	706055X	706058X	36113-27	36113-28
605300-2	Standard	4.10	706998-3X	706051X	706055X	706058X	36113-27	36113-28
605300-3	Powr Lok	4.10	706998-3X	707073X	706053X	707074X	36113-27	36113-28
605300-4	Standard	4.56	706998-4X	706052X	706056X	706058X	36113-27	36113-28
605300-5	Powr Lok	3.54	706998-1X	707073X	706053X	707074X	36113-27	36113-28
1987 1/2 E-350 - DRW - 70HD								
605344-1	Standard	4.10	706999-4X	706064X	706068X	706058X	36113-27	36113-28
605344-2	Standard	3.54	706999-1X	706064X	706068X	706058X	36113-27	36113-28
605344-3	Powr Lok	3.54	706999-1X	707088X	707029X	707074X	36113-27	36113-28
605344-4	Powr Lok	4.10	706999-4X	707088X	707029X	707074X	36113-27	36113-28
1987 1/2 E-350 - DRW - 70U								
605352-1	Standard	4.10	706998-3X	706051X	706055X	706058X	36113-27	36113-28
605352-2	Standard	4.56	706998-4X	706052X	706056X	706058X	36113-27	36113-28
1988 1/2-89 E-350 U-Haul - 70HD								
605337-1	Standard	3.54	706999-1X	706064X	706068X	706058X	36113-27	36113-28
605337-2	Standard	4.10	706999-4X	706064X	706068X	706058X	36113-27	36113-28
1989 E-350 - DRW - 70U								
605412-1	Standard	3.54	706998-1X	707215X	707216X	706058X	36113-27	36113-28
605412-2	Standard	4.10	706998-3X	707215X	707216X	706058X	36113-27	36113-28
605412-3	Powr Lok	4.10	706998-3X	707145X	707146X	707074X	36113-27	36113-28
605412-4	Standard	4.56	706998-4X	707176X	707177X	706058X	36113-27	36113-28

(7) See Ring Gear & Pinion Kits in XGI Catalog for ratio & tooth combinations.

(8) See Differential Case Assy Kits in XGI Catalog for spline data & ratios.

(9) May require 34848-10 & 34848-28 differential bearing spacers.

Ford Model 70 /267 Rear Axles

Bill of Material Table

Axle			Axle Kits				Shaft & Joint Assy.	
Bill of Material	Diff. Type	Ratio	Ring Gear & Pinion Kit ⁽⁷⁾	Differential			Right Hand Shaft Assy.	Left Hand Shaft Assy.
				Case Assy. Kit ⁽⁸⁾	Case Kit	Inner Parts Kit		
1989-90 E-350 Motor Home - 70HD								
605438-1	Standard	4.10	706999-4X	706064X	706068X	706058X	36113-27	36113-28
605438-2	Standard	3.54	706999-1X	706064X	706068X	706058X	36113-27	36113-28
605438-3	Powr Lok	3.54	706999-1X	707088X	707029X	707074X	36113-27	36113-28
605438-4	Powr Lok	4.10	706999-4X	707088X	707029X	707074X	36113-27	36113-28
1989-90 1/2 E-350 Motor Home - 70U								
605437-1	Standard	4.10	706998-3X	707215X	707216X	706058X	36113-27	36113-28
605437-2	Standard	4.56	706998-4X	707176X	707177X	706058X	36113-27	36113-28
1990-91 1/2 E-350 - DRW - ABS - 70U								
605421-1	Standard	3.54	706998-1X	707215X	707216X	706058X	36113-27	36113-28
605421-2	Standard	4.10	706998-3X	707215X	707216X	706058X	36113-27	36113-28
605421-3	Powr Lok	4.10	706998-3X	707145X	707146X	707074X	36113-27	36113-28
1990-91 1/2 UPS - ABS - 70U								
605518-1	Standard	4.10	706998-3X	707241X	707216X	707119X	36113-27	36113-28
1990-91 1/2 E-350 Motor Home - ABS - 70HD								
605471-1	Standard	4.10	706999-4X	707186X	707187X	706058X	36113-27	36113-28
605471-2	Standard	3.54	706999-1X	707186X	707187X	706058X	36113-27	36113-28
605471-3	Powr Lok	3.54	706999-1X	707189X	707188X	707074X	36113-27	36113-28
605471-4	Powr Lok	4.10	706999-4X	707189X	707188X	707074X	36113-27	36113-28
1990-91 1/2 E-350 U-Haul - ABS - 70HD								
605480-1	Standard	3.54	706999-1X	707186X	707187X	706058X	36113-27	36113-28
605480-2	Standard	4.10	706999-4X	707186X	707187X	706058X	36113-27	36113-28
1991-91 1/2 Continental Bakery Chassis - ABS - 70U								
605501-1	Standard	3.54	706998-1X	707215X	707216X	706058X	36113-27	36113-28
605501-2	Standard	4.10	706998-3X	707215X	707216X	706058X	36113-27	36113-28
1992 Continental Bakery - ABS - 70U								
605537-2	Standard	4.10	706998-3X	707215X	707216X	706058X	36113-27	36113-28
1992 E-350 - DRW - ABS - 70U								
605488-1	Standard	3.54	706998-1X	707215X	707216X	706058X	36113-27	36113-28
605488-2	Standard	4.10	706998-3X	707215X	707216X	706058X	36113-27	36113-28
605488-3	Powr Lok	4.10	706998-3X	707145X	707146X	707074X	36113-27	36113-28
1992-92 1/2 UPS - ABS - 70U								
605540-1	Standard	4.10	706998-3X	707241X	707216X	707119X	36113-27	36113-28
1992-93 1/2 E-350 Motor Home - ABS - 70HD								
605538-1	Standard	4.10	706999-4X	707186X	707187X	706058X	36113-27	36113-28
605538-2	Standard	3.54	706999-1X	707186X	707187X	706058X	36113-27	36113-28
605538-3	Powr Lok	3.54	706999-1X	707189X	707188X	707074X	36113-27	36113-28
605538-4	Powr Lok	4.10	706999-4X	707189X	707188X	707074X	36113-27	36113-28
605538-5	Standard	4.10	706999-4X	707186X	707187X	706058X	36113-27	36113-28
605538-6	Standard	3.54	706999-1X	707186X	707187X	706058X	36113-27	36113-28
605538-7	Powr Lok	3.54	706999-1X	707189X	707188X	707074X	36113-27	36113-28
605538-8	Powr Lok	4.10	706999-4X	707189X	707188X	707074X	36113-27	36113-28
605538-9	Standard	4.10	706999-4X	707186X	707187X	706058X	36113-27	36113-28
605538-10	Powr Lok	4.10	706999-4X	707189X	707188X	707074X	36113-27	36113-28
1992-93 1/2 E-350 U-Haul - ABS - 70HD								
605539-1	Standard	3.54	706999-1X	707186X	707187X	706058X	36113-27	36113-28
605539-2	Standard	4.10	706999-4X	707186X	707187X	706058X	36113-27	36113-28

(7) See Ring Gear & Pinion Kits in XGI Catalog for ratio & tooth combinations.

(8) See Differential Case Assy Kits in XGI Catalog for spline data & ratios.

(9) May require 34848-10 & 34848-28 differential bearing spacers.

Ford Model 70 /267 Rear Axles

Bill of Material Table

Axle			Axle Kits				Shaft & Joint Assy.	
Bill of Material	Diff. Type	Ratio	Ring Gear & Pinion Kit ⁽⁷⁾	Differential			Right Hand Shaft Assy.	Left Hand Shaft Assy.
				Case Assy. Kit ⁽⁸⁾	Case Kit	Inner Parts Kit		
1992 1/2-93 1/2 Continental Bakery - ABS - 70U								
605583-1	Standard	4.10	706998-3X	707276X	707216X	707252X	43811-4	43811-7
1992 1/2-93 1/2 UPS - ABS - 70U								
605584-1	Standard	4.10	706998-3X	707312X	707216X	707313X	43811-4	43811-7
1992 1/2-93 1/2 E-350 - DRW - ABS - 70U								
605567-1	Standard	3.54	706998-1X	707276X	707216X	707252X	43811-4	43811-7
605567-2	Standard	4.10	706998-3X	707276X	707216X	707252X	43811-4	43811-7
605567-3	Powr Lok	4.10	706998-3X	707277X	707146X	707254X	43811-4	43811-7
605567-4	Standard	3.54	706998-1X	707276X	707216X	707252X	43811-4	43811-7
605567-5	Standard	4.10	706998-3X	707276X	707216X	707252X	43811-4	43811-7
605567-6	Powr Lok	4.10	706998-3X	707277X	707146X	707254X	43811-4	43811-7
1992 1/2-93 1/2 E-350 SRW Cutaway, Wide Track - ABS - 70 2U								
605578-1	Standard	4.10	706998-3X	707276X	707216X	707252X	43811-4	43811-7
605578-2	Powr Lok	4.10	706998-3X	707277X	707146X	707254X	43811-4	43811-7
1993 1/2-94 E-350 - DRW - ABS - 70U								
605608-1	Standard	4.10	706998-3X	707276X	707216X	707252X	43811-4	43811-7
605608-2	Powr Lok	4.10	706998-3X	707277X	707146X	707254X	43811-4	43811-7
605665-1	Standard	4.10	706999-4X	707186X	707187X	706058X	36113-27	36113-28
605666-1	Standard	4.10	706999-4X	707186X	707187X	706058X	36113-27	36113-28
1993 1/2-94 E-350 Motor Home - ABS - 70HD								
605609-1	Standard	4.10	706999-4X	707186X	707187X	706058X	36113-27	36113-28
605609-2	Powr Lok	4.10	706999-4X	707189X	707188X	707074X	36113-27	36113-28
1993 1/2-94 E-350 SRW Cutaway, Wide Track - ABS - 70 2U								
605669-1	Standard	4.10	706998-3X	707276X	707216X	707252X	43811-4	43811-7
1993 1/2-94 1/2 E-350 - DRW - ABS - 70U								
605667-1	Standard	4.10	706999-4X	707186X	707187X	706058X	36113-27	36113-28
1994 E-350 - DRW - ABS - 70U								
605671-1	Standard	4.10	706998-3X	707276X	707216X	707252X	43811-4	43811-7
605671-2	Powr Lok	4.10	706998-3X	707277X	707146X	707254X	43811-4	43811-7
1994 E-350 - DRW - ABS - 70HD								
605692-1	Standard	4.10	706999-4X	707186X	707187X	706058X	36113-27	36113-28
605693-1	Standard	4.10	706999-4X	707186X	707187X	706058X	36113-27	36113-28
1994-94 1/2 E-350 - ABS - 70U								
605640-1	Standard	4.10	706998-3X	707312X	707216X	707313X	43811-4	43811-7
1994-94 1/2 E-350 - DRW - ABS - 70U								
605673-1	Standard	4.10	706998-3X	707276X	707216X	707252X	43811-4	43811-7
605673-2	Powr Lok	4.10	706998-3X	707277X	707146X	707254X	43811-4	43811-7
1994-94 1/2 E-350 Motor Home - ABS - 70HD								
605672-1	Standard	4.10	706999-4X	707186X	707187X	706058X	36113-27	36113-28
605672-2	Powr Lok	4.10	706999-4X	707189X	707188X	707074X	36113-27	36113-28
605675-1	Standard	4.10	706999-4X	707186X	707187X	706058X	36113-27	36113-28
605675-2	Powr Lok	4.10	706999-4X	707189X	707188X	707074X	36113-27	36113-28
1994 1/2-95 E-350 - DRW - ABS - 70HD								
605714-1	Standard	4.10	706998-3X	707276X	707216X	707252X	43811-4	43811-7
605714-2	Powr Lok	4.10	706998-3X	707277X	707146X	707254X	43811-4	43811-7

(7) See Ring Gear & Pinion Kits in XGI Catalog for ratio & tooth combinations.

(8) See Differential Case Assy Kits in XGI Catalog for spline data & ratios.

Ford Model 70 /267 Rear Axles

Bill of Material Table

Axle			Axle Kits				Shaft & Joint Assy.	
Bill of Material	Diff. Type	Ratio	Ring Gear & Pinion Kit ⁽⁷⁾	Differential			Right Hand Shaft Assy.	Left Hand Shaft Assy.
				Case Assy. Kit ⁽⁸⁾	Case Kit	Inner Parts Kit		
1994 1/2-95 E-350 Motor Home - ABS - 70HD								
605715-1	Standard	4.10	706999-4X	707186X	707187X	706058X	36113-27	36113-28
605715-2	Powr Lok	4.10	706999-4X	707189X	707188X	707074X	36113-27	36113-28
1995-95 1/2 E-350 - DRW - ABS - 70U								
605687-1	Standard	4.10	706998-3X	707276X	707216X	707252X	43811-4	43811-7
605687-2	Powr Lok	4.10	706998-3X	707277X	707146X	707254X	43811-4	43811-7
605687-3	Standard	4.10	706998-3X	707276X	707216X	707252X	43811-4	43811-7
605687-4	Powr Lok	4.10	706998-3X	707277X	707146X	707254X	43811-4	43811-7
605689-1	Standard	4.10	706998-3X	707276X	707216X	707252X	43811-4	43811-7
605689-2	Powr Lok	4.10	706998-3X	707277X	707146X	707254X	43811-4	43811-7
605689-3	Standard	4.10	706998-3X	707276X	707216X	707252X	43811-4	43811-7
605689-4	Powr Lok	4.10	706998-3X	707277X	707146X	707254X	43811-4	43811-7
605845-1	Standard	4.10	706998-3X	707276X	707216X	707252X	43811-4	43811-7
605845-2	Powr Lok	4.10	706998-3X	707277X	707146X	707254X	43811-4	43811-7
1995-95 1/2 E-350 SRW Cutaway, Wide Track - ABS - 70 2U								
605686-1	Standard	4.10	706998-3X	707276X	707216X	707252X	43811-4	43811-7
605686-2	Powr Lok	4.10	706998-3X	707277X	707146X	707254X	43811-4	43811-7
605686-3	Standard	4.10	706998-3X	707276X	707216X	707252X	43811-4	43811-7
605686-4	Powr Lok	4.10	706998-3X	707277X	707146X	707254X	43811-4	43811-7
605844-1	Standard	4.10	706998-3X	707276X	707216X	707252X	43811-4	43811-7
605844-2	Powr Lok	4.10	706998-3X	707277X	707146X	707254X	43811-4	43811-7
1995-95 1/2 E-350 Motor Home - 70HD								
605688-1	Standard	4.10	706999-4X	707186X	707187X	706058X	36113-27	36113-28
605688-2	Powr Lok	4.10	706999-4X	707189X	707188X	707074X	36113-27	36113-28
605688-3	Standard	4.10	706999-4X	707186X	707187X	706058X	36113-27	36113-28
605688-4	Powr Lok	4.10	706999-4X	707189X	707188X	707074X	36113-27	36113-28
1995-95 1/2 E-350 Motor Home - ABS - 70HD								
605690-1	Standard	4.10	706999-4X	707186X	707187X	706058X	36113-27	36113-28
605690-2	Powr Lok	4.10	706999-4X	707189X	707188X	707074X	36113-27	36113-28
605690-3	Standard	4.10	706999-4X	707186X	707187X	706058X	36113-27	36113-28
605690-4	Powr Lok	4.10	706999-4X	707189X	707188X	707074X	36113-27	36113-28
1996 E-350 Motor Home - ABS - 70HD								
605929-1	Standard	4.10	706999-4X	707186X	707187X	706058X	36113-27	36113-28
1996-97 E-350 Motor Home - ABS - 70HD								
605846-1	Standard	4.10	706999-4X	707186X	707187X	706058X	36113-27	36113-28
605846-2	Powr Lok	4.10	706999-4X	707189X	707188X	707074X	36113-27	36113-28
605848-1	Standard	4.10	706999-4X	707186X	707187X	706058X	36113-27	36113-28
605848-2	Powr Lok	4.10	706999-4X	707189X	707188X	707074X	36113-27	36113-28
1996-97 E-350 - DRW - ABS - 70U								
605847-1	Standard	4.10	706998-3X	707276X	707216X	707252X	43811-4	43811-7
605847-2	Powr Lok	4.10	706998-3X	707277X	707146X	707254X	43811-4	43811-7
605860-1	Standard	3.73	706998-2X	707276X	707216X	707252X	43811-4	43811-7
605861-1	Standard	3.73	706998-2X	707276X	707216X	707252X	43811-4	43811-7
605862-1	Standard	4.10	706999-4X	707186X	707187X	706058X	36113-27	36113-28

(7) See Ring Gear & Pinion Kits in XGI Catalog for ratio & tooth combinations.

(8) See Differential Case Assy Kits in XGI Catalog for spline data & ratios.

Ford Model 70 /267 Rear Axles

Bill of Material Table

Axle			Axle Kits				Shaft & Joint Assy.	
Bill of Material	Diff. Type	Ratio	Ring Gear & Pinion Kit ⁽⁷⁾	Differential			Right Hand Shaft Assy.	Left Hand Shaft Assy.
				Case Assy. Kit ⁽⁸⁾	Case Kit	Inner Parts Kit		
1997 E-350 - DRW - ABS - 70U								
605951-1	Standard	4.10	707407-1X	707276-1X	707216X	707252X	43811-4	43811-7
605951-2	Powr Lok	4.10	707407-1X	707277-1X	707146-1X	707254X	43811-4	43811-7
1997 E-350 SRW Cutaway, Wide Track - ABS - 70 2U								
605950-1	Standard	4.10	707407-1X	707276-1X	707216-1X	707252X	43811-4	43811-7
605950-2	Powr Lok	4.10	707407-1X	707277-1X	707146-1X	707254X	43811-4	43811-7
1997 1/2-98 1/2 E-350 - DRW								
606028-1	Standard	4.10	707482-1X	707483X	707484X	706058X	36113-27	36113-28
606028-2	Standard	4.56	707482-2X	707483X	707484X	706058X	36113-27	36113-28
1998 E350 - DRW - ABS								
606160-1	Standard	4.10	707482-1X	707483X	707484X	706058X	36113-27	36113-28
1998-98 1/2 E-350 - DRW - ABS - 70U								
606021-1	Standard	4.10	707407-1X	707276-1X	707216-1X	707252X	43811-4	43811-7
606021-2	Powr Lok	4.10	707407-1X	707277-1X	707146-1X	707254X	43811-4	43811-7
1998-98 1/2 E-350 SRW Cutaway, Wide Track - ABS - 70U								
606020-1	Standard	4.10	707407-1X	707276-1X	707216-1X	707252X	43811-4	43811-7
606020-2	Powr Lok	4.10	707407-1X	707277-1X	707146-1X	707254X	43811-4	43811-7
1998 1/2 E-350 DRW - Full Float - ABS								
606159-1	Standard	4.10	707407-1X	707276-1X	707216-1X	707252X	43811-4	43811-7
606159-2	Powr Lok	4.10	707407-1X	707277-1X	707146-1X	707254X	43811-4	43811-7
1998 1/2-99 E-350 Cutaway SRW or DRW Option - ABS								
606158-1	Standard	4.10	707407-1X	707276X	707216X	707252X	43811-4	43811-7
606158-2	Powr Lok	4.10	707407-1X	707277-1X	707146-1X	707254X	43811-4	43811-7

(7) See Ring Gear & Pinion Kits in XGI Catalog for ratio & tooth combinations.

(8) See Differential Case Assy Kits in XGI Catalog for spline data & ratios.

Ford Model 70 /267 Rear Axles Variable Parts Listing

Kits & Parts - Use With All Applications							
Description & Item Number (Refer to "Exploded View" at the front of this section)			Bills of Material				
			603909	603934	603935	603936	603937 603938
1	KIT – Inner Pinion Bearing	3	706060X	706060X	706060X	706060X	706060X
2	PKG – Pinion Bearing Shim	-	706357X	706357X	706357X	706357X	706357X
3	Baffle – Pinion Bearing	5	34849	—	—	—	—
4	PKG – Diff & Pinion Bearing Shim	-	706213X	706213X	706213X	706213X	706213X
5	End Yoke Assembly (inc 11)	10	3-4-5731X	2-4-5311X	3-4-5731X	3-4-5731X	2-4-5311X
6	Slinger – End Yoke	11	34592	34592	34592	34592	34592
7	Companion Flange Assembly	14	—	—	—	—	—
8	KIT – Carrier Cover	-	706059X	707104X	707104X	707104X	707104X
9	Carrier Cover	15	34055	42815-2	42815-2	42815-2	42815-2
10	Plug – Carrier Cover	17	36472	43180	43180	43180	43180
11	Bolt – Carrier Cover (qty 10)	18	34822	34822	34822	34822	34822
12	KIT – Differential Bearing	21	706070X	706047X	706047X	706047X	706047X
13	PKG – Diff Bearing Shim (inc 16)	22	708012	708012	708012	708012	708012
14	Bolt – Drive Gear (qty 12)	24	30266	30266	30266	30266	30266
15	Gear – Differential (std)	26	35079	35079	35079	35079	35079
16	Spacer – Differential Bearing	30	—	—	—	—	—
17	Tone Ring	31	—	—	—	—	—
18	Seal – Hub	34	46004	46004	46004	46004	46004
19	KIT – Inner Wheel Bearing	35	—	—	—	—	—
20	KIT – Outer Wheel Bearing	36	—	—	—	—	—
21	Spindle Nut / Wheel Bearing Retainer	38	—	—	—	—	—
22	Wheel Bearing Retainer (Left Hand)	-	—	—	—	—	—
23	Locking Wedge	39	—	—	—	—	—
24	Gear – Differential (p/l)	48	35294	35294	35294	—	35294
25	Lockwasher	51	36526	36526	36526	36526	36526
26	Screw – Flange Head	52	39694	39694	39694	39694	39694
			603940	603949	603962	605038	605042
1	KIT – Inner Pinion Bearing	3	706060X	706060X	706060X	706060X	706060X
2	PKG – Pinion Bearing Shim	-	706357X	706357X	706357X	706357X	706357X
3	Baffle – Pinion Bearing	5	—	—	—	—	—
4	PKG – Diff & Pinion Bearing Shim	-	706213X	706213X	706213X	706213X	706213X
5	End Yoke Assembly (inc 11)	10	3-4-5731X	2-4-5311X	2-4-5311X	2-4-8051X	2-4-5311X
6	Slinger – End Yoke	11	34592	34592	34592	41195	34592
7	Companion Flange Assembly	14	—	—	—	—	—
8	KIT – Carrier Cover	-	707104X	707104X	707104X	707104X	707104X
9	Carrier Cover	15	42815-2	42815-2	42815-2	42815-2	42815-2
10	Plug – Carrier Cover	17	43180	43180	43180	43180	43180
11	Bolt – Carrier Cover (qty 10)	18	34822	34822	34822	34822	34822
12	KIT – Differential Bearing	21	706070X	706070X	706047X	706047X	706047X
13	PKG – Diff Bearing Shim (inc 16)	22	708012	708012	708012	708012	708012
14	Bolt – Drive Gear (qty 12)	24	30266	30266	30266	30266	30266
15	Gear – Differential (std)	26	35079	35079	35079	35079	35079
16	Spacer – Differential Bearing	30	—	—	—	—	—
17	Tone Ring	31	—	—	—	—	—
18	Seal – Hub	34	46004	46004	46004	46004	46004
19	KIT – Inner Wheel Bearing	35	—	—	—	706179X	706179X
20	KIT – Outer Wheel Bearing	36	—	—	—	706074X	706074X
21	Spindle Nut / Wheel Bearing Retainer	38	—	—	—	39695	39695
22	Wheel Bearing Retainer (Left Hand)	-	—	—	—	—	—
23	Locking Wedge	39	—	—	—	41373	41373
24	Gear – Differential (p/l)	48	35294	35294	35294	35294	35294
25	Lockwasher	51	36526	36526	36526	36526	36526
26	Screw – Flange Head	52	39694	39694	39694	39694	39694

(See next page for additional bills of material)

Ford Model 70 /267 Rear Axles Variable Parts Listing

Kits & Parts - Use With All Applications							
Description & Item Number (Refer to "Exploded View" at the front of this section)			Bills of Material				
			605044 605045	605053	605054	605055	605057
1	KIT – Inner Pinion Bearing	3	706060X	706060X	706060X	706060X	706060X
2	PKG – Pinion Bearing Shim	-	706357X	706357X	706357X	706357X	706357X
3	Baffle – Pinion Bearing	5	—	—	—	—	—
4	PKG – Diff & Pinion Bearing Shim	-	706213X	706213X	706213X	706213X	706213X
5	End Yoke Assembly (inc 11)	10	2-4-5311X	2-4-8051X	3-4-5731X	2-4-5311X	2-4-5311X
6	Slinger – End Yoke	11	34592	41195	34592	34592	34592
7	Companion Flange Assembly	14	—	—	—	—	—
8	KIT – Carrier Cover	-	707104X	707104X	707104X	707104X	707104X
9	Carrier Cover	15	42815-2	42815-2	42815-2	42815-2	42815-2
10	Plug – Carrier Cover	17	43180	43180	43180	43180	43180
11	Bolt – Carrier Cover (qty 10)	18	34822	34822	34822	34822	34822
12	KIT – Differential Bearing	21	706070X	706070X	706047X	706070X	706047X
13	PKG – Diff Bearing Shim (inc 16)	22	708012	708012	708012	708012	708012
14	Bolt – Drive Gear (qty 12)	24	30266	30266	30266	30266	30266
15	Gear – Differential (std)	26	35079	35079	35079	35079	35079
16	Spacer – Differential Bearing	30	—	—	—	—	—
17	Tone Ring	31	—	—	—	—	—
18	Seal – Hub	34	46004	46004	46004	46004	46004
19	KIT – Inner Wheel Bearing	35	706179X	706179X	706179X	706179X	706179X
20	KIT – Outer Wheel Bearing	36	706074X	706074X	706074X	706074X	706074X
21	Spindle Nut / Wheel Bearing Retainer	38	39695	39695	39695	39695	39695
22	Wheel Bearing Retainer (Left Hand)	-	—	—	—	—	—
23	Locking Wedge	39	41373	41373	41373	41373	41373
24	Gear – Differential (p/l)	48	35294	35294	—	35294	35294
25	Lockwasher	51	36526	36526	36526	36526	36526
26	Screw – Flange Head	52	39694	39694	39694	39694	39694
			605080	605101	605114	605115	605118 605138
1	KIT – Inner Pinion Bearing	3	706060X	706060X	706861X	706861X	706060X
2	PKG – Pinion Bearing Shim	-	706357X	706357X	706359X	706359X	706357X
3	Baffle – Pinion Bearing	5	—	—	—	—	—
4	PKG – Diff & Pinion Bearing Shim	-	706213X	706213X	708020	708020	706213X
5	End Yoke Assembly (inc 11)	10	2-4-5311X	2-4-5311X	2-4-8051X	2-4-5311X	2-4-5311X
6	Slinger – End Yoke	11	34592	34592	41195	34592	34592
7	Companion Flange Assembly	14	—	—	—	—	—
8	KIT – Carrier Cover	-	707104X	707105X	707104X	707104X	707104X
9	Carrier Cover	15	42815-2	42815-2	42815-2	42815-2	42815-2
10	Plug – Carrier Cover	17	43180	43181	43180	43180	43180
11	Bolt – Carrier Cover (qty 10)	18	34822	34822	34822	34822	34822
12	KIT – Differential Bearing	21	706047X	706070X	706047X	706047X	706070X
13	PKG – Diff Bearing Shim (inc 16)	22	708012	706373X	708012	708012	708012
14	Bolt – Drive Gear (qty 12)	24	30266	30266	30266	30266	30266
15	Gear – Differential (std)	26	35079	35079	35079	35079	35079
16	Spacer – Differential Bearing	30	—	34848-28	—	—	—
17	Tone Ring	31	—	—	—	—	—
18	Seal – Hub	34	46004	46004	46004	46004	46004
19	KIT – Inner Wheel Bearing	35	706179X	706179X	706179X	706179X	706179X
20	KIT – Outer Wheel Bearing	36	706074X	706074X	706074X	706074X	706074X
21	Spindle Nut / Wheel Bearing Retainer	38	39695	39695	39695	39695	39695
22	Wheel Bearing Retainer (Left Hand)	-	—	—	—	—	—
23	Locking Wedge	39	41373	41373	41373	41373	41373
24	Gear – Differential (p/l)	48	—	35294	35294	35294	35294
25	Lockwasher	51	36526	36526	36526	36526	36526
26	Screw – Flange Head	52	39694	39694	39694	39694	39694

Ford Model 70 /267 Rear Axles

Variable Parts Listing

Kits & Parts - Use With All Applications							
Description & Item Number (Refer to "Exploded View" at the front of this section)			Bills of Material				
			605139 605143	605170	605175	605176	605204
1	KIT – Inner Pinion Bearing	3	706060X	706060X	706861X	706060X	706861X
2	PKG – Pinion Bearing Shim	-	706357X	706357X	706359X	706357X	706359X
3	Baffle – Pinion Bearing	5	—	—	—	—	—
4	PKG – Diff & Pinion Bearing Shim	-	706213X	706213X	708020	706213X	708020
5	End Yoke Assembly (inc 11)	10	2-4-5311X	2-4-8051X	2-4-8051X	2-4-8051X	2-4-8051X
6	Slinger – End Yoke	11	34592	41195	41195	41195	41195
7	Companion Flange Assembly	14	—	—	—	—	—
8	KIT – Carrier Cover	-	707104X	707104X	707104X	707104X	707104X
9	Carrier Cover	15	42815-2	42815-2	42815-2	42815-2	42815-2
10	Plug – Carrier Cover	17	43180	43180	43180	43180	43180
11	Bolt – Carrier Cover (qty 10)	18	34822	34822	34822	34822	34822
12	KIT – Differential Bearing	21	706047X	706070X	706047X	706070X	706047X
13	PKG – Diff Bearing Shim (inc 16)	22	708012	708012	708012	708012	708012
14	Bolt – Drive Gear (qty 12)	24	30266	30266	30266	30266	30266
15	Gear – Differential (std)	26	35079	35079	35079	35079	35079
16	Spacer – Differential Bearing	30	—	—	—	—	—
17	Tone Ring	31	—	—	—	—	—
18	Seal – Hub	34	46004	46004	46004	46004	46004
19	KIT – Inner Wheel Bearing	35	706179X	706179X	706179X	706179X	706179X
20	KIT – Outer Wheel Bearing	36	706074X	706074X	706074X	706074X	706074X
21	Spindle Nut / Wheel Bearing Retainer	38	39695	39695	39695	39695	39695
22	Wheel Bearing Retainer (Left Hand)	-	—	—	—	—	—
23	Locking Wedge	39	41373	41373	41373	41373	41373
24	Gear – Differential (p/l)	48	—	35294	35294	35294	35294
25	Lockwasher	51	36526	36526	36526	36526	36526
26	Screw – Flange Head	52	39694	39694	39694	39694	39694
			605206	605207 605205	605208 605213	605246 605247 605248	605249 605250
1	KIT – Inner Pinion Bearing	3	706861X	706060X	706861X	706861X	706860X
2	PKG – Pinion Bearing Shim	-	706357X	706357X	706359X	706359X	706357X
3	Baffle – Pinion Bearing	5	—	41550	—	—	—
4	PKG – Diff & Pinion Bearing Shim	-	708020	706213X	708020	708020	706213X
5	End Yoke Assembly (inc 11)	10	3-4-5731X	2-4-8051X	2-4-8051X	2-4-8051X	2-4-8051X
6	Slinger – End Yoke	11	41195	41195	41195	41195	41195
7	Companion Flange Assembly	14	—	—	—	—	—
8	KIT – Carrier Cover	-	707104X	707105X	707104X	707104X	707104X
9	Carrier Cover	15	42815-2	42815-2	42815-2	42815-2	42815-2
10	Plug – Carrier Cover	17	43180	43181	43180	43180	43180
11	Bolt – Carrier Cover (qty 10)	18	34822	34822	34822	34822	34822
12	KIT – Differential Bearing	21	706047X	706070X	706047X	706047X	706070X
13	PKG – Diff Bearing Shim (inc 16)	22	708012	706373X	708012	708012	708012
14	Bolt – Drive Gear (qty 12)	24	40638	30266	30266	40638	40638
15	Gear – Differential (std)	26	35079	35079	35079	35079	35079
16	Spacer – Differential Bearing	30	—	34848-28	—	—	—
17	Tone Ring	31	—	—	—	—	—
18	Seal – Hub	34	46004	46004	46004	46004	46004
19	KIT – Inner Wheel Bearing	35	706179X	706179X	706179X	706179X	706179X
20	KIT – Outer Wheel Bearing	36	706074X	706074X	706074X	706074X	706074X
21	Spindle Nut / Wheel Bearing Retainer	38	39695	39695	39695	39695	39695
22	Wheel Bearing Retainer (Left Hand)	-	—	—	—	—	—
23	Locking Wedge	39	41373	41373	41373	41373	41373
24	Gear – Differential (p/l)	48	—	35294	35294	35294	35294
25	Lockwasher	51	36526	36526	36526	36526	36526
26	Screw – Flange Head	52	39694	39694	39694	39694	39694

(See next page for additional bills of material)

Ford Model 70 /267 Rear Axles

Variable Parts Listing

Kits & Parts - Use With All Applications							
Description & Item Number (Refer to "Exploded View" at the front of this section)			Bills of Material				
			605253	605255	605300	605337	605344
1	KIT – Inner Pinion Bearing	3	706861X	706060X	706861X	706060X	706060X
2	PKG – Pinion Bearing Shim	-	706359X	706357X	706359X	706357X	706357X
3	Baffle – Pinion Bearing	5	—	—	—	—	—
4	PKG – Diff & Pinion Bearing Shim	-	708020	706213X	708020	706213X	706213X
5	End Yoke Assembly (inc 11)	10	2-4-8051X	2-4-8051X	2-4-8051X	2-4-8051X	2-4-8051X
6	Slinger – End Yoke	11	41195	41195	41195	41195	41195
7	Companion Flange Assembly	14	—	—	—	—	—
8	KIT – Carrier Cover	-	707104X	707104X	707104X	707105X	707104X
9	Carrier Cover	15	42815-2	42815-2	42815-2	42815-2	42815-2
10	Plug – Carrier Cover	17	43180	43180	43180	43181	43180
11	Bolt – Carrier Cover (qty 10)	18	34822	34822	34822	34822	34822
12	KIT – Differential Bearing	21	706047X	706070X	706047X	706070X	706070X
13	PKG – Diff Bearing Shim (inc 16)	22	708012	708012	708012	706373X	708012
14	Bolt – Drive Gear (qty 12)	24	30266	40638	30266	30266	30266
15	Gear – Differential (std)	26	35079	35079	35079	35079	35079
16	Spacer – Differential Bearing	30	—	—	—	34848-28	—
17	Tone Ring	31	—	—	—	—	—
18	Seal – Hub	34	46004	46004	46004	46004	46004
19	KIT – Inner Wheel Bearing	35	706179X	706179X	706179X	706179X	706179X
20	KIT – Outer Wheel Bearing	36	706074X	706074X	706074X	706074X	706074X
21	Spindle Nut / Wheel Bearing Retainer	38	39695	39695	43075	43075	43075
22	Wheel Bearing Retainer (Left Hand)	-	—	—	43076	43076	43076
23	Locking Wedge	39	41373	41373	—	—	—
24	Gear – Differential (p/l)	48	35294	35294	35294	—	35294
25	Lockwasher	51	36526	36526	36526	36526	36526
26	Screw – Flange Head	52	39694	39694	39694	39694	39694
			605352	605412	605421	605437	605438
1	KIT – Inner Pinion Bearing	3	706861X	706861X	706861X	706861X	706060X
2	PKG – Pinion Bearing Shim	-	706359X	706359X	706359X	706359X	706357X
3	Baffle – Pinion Bearing	5	—	—	—	—	—
4	PKG – Diff & Pinion Bearing Shim	-	708020	708020	708020	708020	706213X
5	End Yoke Assembly (inc 11)	10	2-4-8051X	2-4-8051X	2-4-8051X	2-4-8051X	2-4-8051X
6	Slinger – End Yoke	11	41195	41195	41195	41195	41195
7	Companion Flange Assembly	14	—	—	—	—	—
8	KIT – Carrier Cover	-	707104X	707104X	707105X	707104X	707104X
9	Carrier Cover	15	42815-2	42815-2	42815-2	42815-2	42815-2
10	Plug – Carrier Cover	17	43180	43180	43181	43180	43180
11	Bolt – Carrier Cover (qty 10)	18	34822	34822	34822	34822	34822
12	KIT – Differential Bearing	21	706047X	706047X	706047X	706047X	706070X
13	PKG – Diff Bearing Shim (inc 16)	22	708012	708012	708012	708012	706373X
14	Bolt – Drive Gear (qty 12)	24	30266	30266	30266	30266	30266
15	Gear – Differential (std)	26	35079	35079	35079	35079	35079
16	Spacer – Differential Bearing	30	—	42563	42563	42563	34848-28
17	Tone Ring	31	—	—	42929	—	—
18	Seal – Hub	34	46004	46004	46004	46004	46004
19	KIT – Inner Wheel Bearing	35	706179X	706179X	706179X	706179X	706179X
20	KIT – Outer Wheel Bearing	36	706074X	706074X	706074X	706074X	706074X
21	Spindle Nut / Wheel Bearing Retainer	38	43075	43075	43075	43075	43075
22	Wheel Bearing Retainer (Left Hand)	-	43076	43076	—	43076	43076
23	Locking Wedge	39	—	—	—	—	—
24	Gear – Differential (p/l)	48	—	35294	35294	—	35294
25	Lockwasher	51	36526	36526	36526	36526	36526
26	Screw – Flange Head	52	39694	39694	39694	39694	39694

Ford Model 70 /267 Rear Axles

Variable Parts Listing

Kits & Parts - Use With All Applications							
Description & Item Number (Refer to "Exploded View" at the front of this section)			Bills of Material				
			605471	605480	605488	605501 605518 605537	605538
1	KIT – Inner Pinion Bearing	3	706060X	706060X	706861X	706861X	706060X
2	PKG – Pinion Bearing Shim	-	706357X	706357X	706359X	706359X	706357X
3	Baffle – Pinion Bearing	5	—	—	—	—	—
4	PKG – Diff & Pinion Bearing Shim	-	706213X	706213X	708020	708020	706213X
5	End Yoke Assembly (inc 11)	10	2-4-8051X	2-4-8051X	2-4-8051X	2-4-8051X	2-4-8051X
6	Slinger – End Yoke	11	41195	41195	41195	41195	41195
7	Companion Flange Assembly	14	—	—	—	—	—
8	KIT – Carrier Cover	-	707105X	707104X	707105X	707105X	707105X
9	Carrier Cover	15	42815-2	42815-2	42815-2	42815-2	42815-2
10	Plug – Carrier Cover	17	43181	43180	43181	43181	43181
11	Bolt – Carrier Cover (qty 10)	18	34822	34822	34822	34822	34822
12	KIT – Differential Bearing	21	706070X	706070X	706047X	706047X	706070X
13	PKG – Diff Bearing Shim (inc 16)	22	706373X	706373X	708012	708012	706373X
14	Bolt – Drive Gear (qty 12)	24	30266	30266	30266	30266	30266
15	Gear – Differential (std)	26	35079	35079	35079	35079	35079
16	Spacer – Differential Bearing	30	34848-28	34848-28	42563	42563	34848-28
17	Tone Ring	31	42929	42929	42929	42929	42929
18	Seal – Hub	34	46004	46004	46004	46004	46004
19	KIT – Inner Wheel Bearing	35	706179X	706179X	706179X	706179X	706179X
20	KIT – Outer Wheel Bearing	36	706074X	706074X	706074X	706074X	706074X
21	Spindle Nut / Wheel Bearing Retainer	38	—	—	—	—	43075
22	Wheel Bearing Retainer (Left Hand)	-	—	—	—	—	—
23	Locking Wedge	39	43075	43075	43075	43075	—
24	Gear – Differential (p/l)	48	35294	—	35294	—	35294
25	Lockwasher	51	36526	36526	36526	36526	36526
26	Screw – Flange Head	52	39694	39694	39694	39694	39694
			605539	605540	605567	605578	605583 605584
1	KIT – Inner Pinion Bearing	3	706060X	706861X	706861X	706861X	706861X
2	PKG – Pinion Bearing Shim	-	706357X	706359X	706359X	706359X	706359X
3	Baffle – Pinion Bearing	5	—	—	—	—	—
4	PKG – Diff & Pinion Bearing Shim	-	706213X	708020	708020	708020	708020
5	End Yoke Assembly (inc 11)	10	2-4-8051X	2-4-8051X	2-4-8051X	2-4-8051X	2-4-8051X
6	Slinger – End Yoke	11	41195	41195	41195	41195	41195
7	Companion Flange Assembly	14	—	—	—	—	—
8	KIT – Carrier Cover	-	707105X	707105X	707105X	707105X	707105X
9	Carrier Cover	15	42815-2	42815-2	42815-2	42815-2	42815-2
10	Plug – Carrier Cover	17	43181	43181	43181	43181	43181
11	Bolt – Carrier Cover (qty 10)	18	34822	34822	34822	34822	34822
12	KIT – Differential Bearing	21	706070X	706047X	706047X	706047X	706047X
13	PKG – Diff Bearing Shim (inc 16)	22	706373X	708012	708012	708012	708012
14	Bolt – Drive Gear (qty 12)	24	30266	30266	30266	30266	30266
15	Gear – Differential (std)	26	35079	35079	43913	43913	43913
16	Spacer – Differential Bearing	30	34848-28	42563	42563	42563	42563
17	Tone Ring	31	42929	42929	42929	42929	42929
18	Seal – Hub	34	46004	46004	46004	46004	46004
19	KIT – Inner Wheel Bearing	35	706179X	706179X	706179X	706179X	706179X
20	KIT – Outer Wheel Bearing	36	706074X	706074X	706074X	706074X	706074X
21	Spindle Nut / Wheel Bearing Retainer	38	43075	43075	43075	43075	43075
22	Wheel Bearing Retainer (Left Hand)	-	—	—	—	—	—
23	Locking Wedge	39	—	—	—	—	—
24	Gear – Differential (p/l)	48	—	—	43914	43914	—
25	Lockwasher	51	—	36526	36526	—	—
26	Screw – Flange Head	52	45720	39694	39694	45720	45720

(See next page for additional bills of material)

Ford Model 70 /267 Rear Axles Variable Parts Listing

Kits & Parts - Use With All Applications							
Description & Item Number (Refer to "Exploded View" at the front of this section)			Bills of Material				
			605608	605609	605640	605665	605666
1	KIT – Inner Pinion Bearing	3	706861X	706060X	706861X	706060X	706060X
2	PKG – Pinion Bearing Shim	-	706359X	706357X	706359X	706357X	706357X
3	Baffle – Pinion Bearing	5	—	—	—	—	—
4	PKG – Diff & Pinion Bearing Shim	-	708020	706213X	708020	706213X	706213X
5	End Yoke Assembly (inc 11)	10	3-4-13031-1X	3-4-13031-1X	2-4-8051X	3-4-13031-1X	2-4-8051X
6	Slinger – End Yoke	11	45799	45799	41195	45799	41195
7	Companion Flange Assembly	14	—	—	—	—	—
8	KIT – Carrier Cover	-	707105X	707105X	707105X	707105X	707105X
9	Carrier Cover	15	42815-2	42815-2	42815-2	42815-2	42815-2
10	Plug – Carrier Cover	17	43181	43181	43181	43181	43181
11	Bolt – Carrier Cover (qty 10)	18	34822	34822	34822	34822	34822
12	KIT – Differential Bearing	21	706047X	706070X	706047X	706070X	706070X
13	PKG – Diff Bearing Shim (inc 16)	22	708012	706373X	708012	706373X	706373X
14	Bolt – Drive Gear (qty 12)	24	30266	30266	30266	30266	30266
15	Gear – Differential (std)	26	43913	35079	43913	35079	35079
16	Spacer – Differential Bearing	30	42563	34848-28	42563	34848-28	34848-28
17	Tone Ring	31	42929	42929	42929	42929	42929
18	Seal – Hub	34	46004	46004	46004	46004	46004
19	KIT – Inner Wheel Bearing	35	706179X	706179X	706179X	706179X	706179X
20	KIT – Outer Wheel Bearing	36	706074X	706074X	706074X	706074X	706074X
21	Spindle Nut / Wheel Bearing Retainer	38	43075	43075	43075	43075	43075
22	Wheel Bearing Retainer (Left Hand)	-	—	—	—	—	—
23	Locking Wedge	39	—	—	—	—	—
24	Gear – Differential (p/l)	48	43914	43914	—	—	—
25	Lockwasher	51	—	—	—	—	—
26	Screw – Flange Head	52	45720	45720	45720	45720	45720
			605667	605669	605671	605672	605673
1	KIT – Inner Pinion Bearing	3	706060X	706861X	706861X	706060X	706861X
2	PKG – Pinion Bearing Shim	-	706357X	706359X	706359X	706357X	706359X
3	Baffle – Pinion Bearing	5	—	—	—	—	—
4	PKG – Diff & Pinion Bearing Shim	-	706213X	708020	708020	706213X	708020
5	End Yoke Assembly (inc 11)	10	3-4-13031-2X	3-4-13031-1X	3-4-13031-2X	3-4-13031-2X	2-4-8051X
6	Slinger – End Yoke	11	45799	45799	45799	45799	41195
7	Companion Flange Assembly	14	—	—	—	—	—
8	KIT – Carrier Cover	-	707105X	707105X	707105X	707105X	707105X
9	Carrier Cover	15	42815-2	42815-2	42815-2	42815-2	42815-2
10	Plug – Carrier Cover	17	43181	43181	43181	43181	43181
11	Bolt – Carrier Cover (qty 10)	18	34822	34822	34822	34822	34822
12	KIT – Differential Bearing	21	706070X	706047X	706047X	706070X	706047X
13	PKG – Diff Bearing Shim (inc 16)	22	706373X	708012	708012	706373X	708012
14	Bolt – Drive Gear (qty 12)	24	30266	30266	30266	30266	30266
15	Gear – Differential (std)	26	35079	43913	43913	35079	43913
16	Spacer – Differential Bearing	30	34848-28	42563	42563	34848-28	42563
17	Tone Ring	31	42929	42929	42929	42929	42929
18	Seal – Hub	34	46004	46004	46004	46004	46004
9	KIT – Inner Wheel Bearing Kit	35	706179X	706179X	706179X	706179X	706179X
20	KIT – Outer Wheel Bearing	36	706074X	706074X	706074X	706074X	706074X
21	Spindle Nut / Wheel Bearing Retainer	38	43075	43075	43075	43075	43075
22	Wheel Bearing Retainer (Left Hand)	-	—	—	—	—	—
23	Locking Wedge	39	—	—	—	—	—
24	Gear – Differential (p/l)	48	—	—	43914	35294	43914
25	Lockwasher	51	—	—	—	—	—
26	Screw – Flange Head	52	45720	45720	45720	45720	45720

Ford Model 70 /267 Rear Axles Variable Parts Listing

Kits & Parts - Use With All Applications							
Description & Item Number (Refer to "Exploded View" at the front of this section)			Bills of Material				
			605675	605686	605687	605688	605689
1	KIT – Inner Pinion Bearing	3	706060X	706861X	706861X	706060X	706861X
2	PKG – Pinion Bearing Shim	-	706357X	706359X	706359X	706357X	706359X
3	Baffle – Pinion Bearing	5	—	—	—	—	—
4	PKG – Diff & Pinion Bearing Shim	-	706213X	708020	708020	706213X	708020
5	End Yoke Assembly (inc 11)	10	2-4-8051X	3-4-13031-2X	2-4-8051X	2-4-8051X	3-4-13031-2X
6	Slinger – End Yoke	11	41195	45799	41195	41195	45799
7	Companion Flange Assembly	14	—	—	—	—	—
8	KIT – Carrier Cover	-	707105X	707105X	707105X	707105X	707105X
9	Carrier Cover	15	42815-2	42815-2	42815-2	42815-2	42815-2
10	Plug – Carrier Cover	17	43181	43181	43181	43181	43181
11	Bolt – Carrier Cover (qty 10)	18	34822	34822	34822	34822	34822
12	KIT – Differential Bearing	21	706070X	706047X	706047X	706070X	706047X
13	PKG – Diff Bearing Shim (inc 16)	22	706373X	708012	708012	706373X	708012
14	Bolt – Drive Gear (qty 12)	24	30266	40638	40638	40638	40638
15	Gear – Differential (std)	26	35079	43913	43913	35079	43913
16	Spacer – Differential Bearing	30	34848-28	42563	42563	34848-28	42563
17	Tone Ring	31	42929	42929	42929	42929	42929
18	Seal – Hub	34	46004	46004	46004	46004	46004
19	KIT – Inner Wheel Bearing	35	706179X	706179X	706179X	706179X	706179X
20	KIT – Outer Wheel Bearing	36	706074X	706074X	706074X	706074X	706074X
21	Spindle Nut / Wheel Bearing Retainer	38	43075	43075	43075	43075	43075
22	Wheel Bearing Retainer (Left Hand)	-	—	—	—	—	—
23	Locking Wedge	39	—	—	—	—	—
24	Gear – Differential (p/l)	48	35294	43914	43914	35294	43914
25	Lockwasher	51	—	—	—	—	—
26	Screw – Flange Head	52	45720	45720	45720	45720	45720
			605690	605692	605693	605714	605715
1	KIT – Inner Pinion Bearing	3	706060X	706060X	706060X	706861X	706060X
2	PKG – Pinion Bearing Shim	-	706357X	706357X	706357X	706359X	706357X
3	Baffle – Pinion Bearing	5	—	—	—	—	—
4	PKG – Diff & Pinion Bearing Shim	-	706213X	706213X	706213X	708020	706213X
5	End Yoke Assembly (inc 11)	10	3-4-13031-2X	3-4-13031-2X	2-4-8051X	3-4-13031-2X	3-4-13031-2X
6	Slinger – End Yoke	11	45799	45799	41195	45799	45799
7	Companion Flange Assembly	14	—	—	—	—	—
8	KIT – Carrier Cover	-	707105X	707105X	707105X	707105X	707105X
9	Carrier Cover	15	42815-2	42815-2	42815-2	42815-2	42815-2
10	Plug – Carrier Cover	17	43181	43181	43181	43181	43181
11	Bolt – Carrier Cover (qty 10)	18	34822	34822	34822	34822	34822
12	KIT – Differential Bearing	21	706070X	706070X	706070X	706047X	706070X
13	PKG – Diff Bearing Shim (inc 16)	22	706373X	706373X	706373X	708012	706373X
14	Bolt – Drive Gear (qty 12)	24	40638	30266	30266	30266	30266
15	Gear – Differential (std)	26	35079	35079	35079	43913	35079
16	Spacer – Differential Bearing	30	34848-28	34848-28	34848-28	42563	34848-28
17	Tone Ring	31	42929	42929	42929	42929	42929
18	Seal – Hub	34	46004	46004	46004	46004	46004
19	KIT – Inner Wheel Bearing	35	706179X	706179X	706179X	706179X	706179X
20	KIT – Outer Wheel Bearing	36	706074X	706074X	706074X	706074X	706074X
21	Spindle Nut / Wheel Bearing Retainer	38	43075	43075	43075	43075	43075
22	Wheel Bearing Retainer (Left Hand)	-	—	—	—	—	—
23	Locking Wedge	39	—	—	—	—	—
24	Gear – Differential (p/l)	48	35294	—	—	43914	35294
25	Lockwasher	51	—	—	—	—	—
26	Screw – Flange Head	52	45720	45720	45720	45720	45720

(See next page for additional bills of material)

Ford Model 70 /267 Rear Axles Variable Parts Listing

Kits & Parts - Use With All Applications							
Description & Item Number (Refer to "Exploded View" at the front of this section)			Bills of Material				
			605844	605845	605846	605847	605848
1	KIT – Inner Pinion Bearing	3	706861X	706861X	706060X	706861X	706060X
2	PKG – Pinion Bearing Shim	-	706359X	706359X	706357X	706359X	706357X
3	Baffle – Pinion Bearing	5	—	—	—	—	—
4	PKG – Diff & Pinion Bearing Shim	-	708020	708020	706213X	708020	706213X
5	End Yoke Assembly (inc 11)	10	3-4-13031-2X	2-4-8051X	2-4-8051X	3-4-13031-2X	3-4-13031-2X
6	Slinger – End Yoke	11	45799	41195	41195	45799	45799
7	Companion Flange Assembly	14	—	—	—	—	—
8	KIT – Carrier Cover	-	707105X	707105X	707105X	707105X	707105X
9	Carrier Cover	15	42815-2	42815-2	42815-2	42815-2	42815-2
10	Plug – Carrier Cover	17	43181	43181	43181	43181	43181
11	Bolt – Carrier Cover (qty 10)	18	34822	34822	34822	34822	34822
12	KIT – Differential Bearing	21	706047X	706047X	706070X	706047X	706070X
13	PKG – Diff Bearing Shim (inc 16)	22	708012	708012	706373X	708012	706373X
14	Bolt – Drive Gear (qty 12)	24	40638	40638	40638	40638	40638
15	Gear – Differential (std)	26	43913	43913	35079	43913	35079
16	Spacer – Differential Bearing	30	42563	42563	34848-28	42563	34848-28
17	Tone Ring	31	42929	42929	42929	42929	42929
18	Seal – Hub	34	46004	46004	46004	46004	46004
19	KIT – Inner Wheel Bearing	35	706179X	706179X	706179X	706179X	706179X
20	KIT – Outer Wheel Bearing	36	706074X	706074X	706074X	706074X	706074X
21	Spindle Nut / Wheel Bearing Retainer	38	43075	43075	43075	43075	43075
22	Wheel Bearing Retainer (Left Hand)	-	—	—	—	—	—
23	Locking Wedge	39	—	—	—	—	—
24	Gear – Differential (p/l)	48	43914	43914	35294	43914	35294
25	Lockwasher	51	—	—	—	—	—
26	Screw – Flange Head	52	45720	45720	45720	45720	45720
			605860	605861	605862	605929	605950 605951
1	KIT – Inner Pinion Bearing	3	706861X	706861X	706060X	706060X	706861X
2	PKG – Pinion Bearing Shim	-	706359X	706359X	706357X	706357X	708709
3	Baffle – Pinion Bearing	5	—	—	—	—	—
4	PKG – Diff & Pinion Bearing Shim	-	708020	708020	706213X	706213X	708078
5	End Yoke Assembly (inc 11)	10	3-4-13031-2X	2-4-8051X	3-4-13031-2X	3-4-13031-2X	—
6	Slinger – End Yoke	11	45799	41195	45799	45799	45799
7	Companion Flange Assembly	14	—	—	—	—	3-1-4881X
8	KIT – Carrier Cover	-	707105X	707105X	707105X	707105X	707105-1X
9	Carrier Cover	15	42815-2	42815-2	42815-2	42815-2	42815-2
10	Plug – Carrier Cover	17	43181	43181	43181	43181	43181
11	Bolt – Carrier Cover (qty 10)	18	34822	34822	34822	34822	47508-1
12	KIT – Differential Bearing	21	706047X	706047X	706070X	706070X	706047X
13	PKG – Diff Bearing Shim (inc 16)	22	708012	708012	706373X	708012	701144X
14	Bolt – Drive Gear (qty 12)	24	40638	40638	40638	40638	40638
15	Gear – Differential (std)	26	43913	43913	35079	35079	43913
16	Spacer – Differential Bearing	30	42563	42563	34848-28	34848-28	47560 ⁽⁹⁾
17	Tone Ring	31	42929	42929	42929	42929	42929
18	Seal – Hub	34	46004	46004	46004	46004	47507
19	KIT – Inner Wheel Bearing	35	706179X	706179X	706179X	706179X	706179X
20	KIT – Outer Wheel Bearing	36	706074X	706074X	706074X	706074X	706074X
21	Spindle Nut / Wheel Bearing Retainer	38	43075	43075	43075	43075	43075
22	Wheel Bearing Retainer (Left Hand)	-	—	—	—	—	—
23	Locking Wedge	39	—	—	—	—	—
24	Gear – Differential (p/l)	48	—	—	—	—	43914
25	Lockwasher	51	—	—	—	—	—
26	Screw – Flange Head	52	45720	45720	45720	45720	45720

Ford Model 70 /267 Rear Axles Variable Parts Listing

Kits & Parts - Use With All Applications							
Description & Item Number (Refer to "Exploded View" at the front of this section)			Bills of Material				
			606020 606021	606028	606158 606159	606160	
1	KIT – Inner Pinion Bearing	3	706861X	706060X	706861X	706060X	
2	PKG – Pinion Bearing Shim	-	708709	708709	708709	708709	
3	Baffle – Pinion Bearing	5	—	—	—	—	
4	PKG – Diff & Pinion Bearing Shim	-	708078	708078	708078	707485X	
5	End Yoke Assembly (inc 11)	10	—	—	—	—	
6	Slinger – End Yoke	11	45799	45799	45799	45799	
7	Companion Flange Assembly	14	3-1-4881X	3-1-4881X	3-1-4881X	3-1-4881X	
8	KIT – Carrier Cover	-	707105-1X	707105-1X	707105-1X	707105-1X	
9	Carrier Cover	15	42815-2	42815-2	42815-2	42815-2	
10	Plug – Carrier Cover	17	43181	43181	43181	43181	
11	Bolt – Carrier Cover (qty 10)	18	47508-1	47508-1	47508-1	47508-1	
12	KIT – Differential Bearing	21	707489X	706070X	707489X	706070X	
13	PKG – Diff Bearing Shim (inc 16)	22	701144X	701144X	701144X	701144X	
14	Bolt – Drive Gear (qty 12)	24	40638	40638	40638	40638	
15	Gear – Differential (std)	26	43913	35079	43913	35079	
16	Spacer – Differential Bearing	30	47560 ⁽⁹⁾	47560 ⁽⁹⁾	47560 ⁽⁹⁾	48849 ⁽⁹⁾	
17	Tone Ring	31	42929	42929	42929	42929	
18	Seal – Hub	34	47507	47507	47507	47507	
19	KIT – Inner Wheel Bearing	35	706179X	706179X	706179X	706179X	
20	KIT – Outer Wheel Bearing	36	706074X	706074X	706074X	706074X	
21	Spindle Nut / Wheel Bearing Retainer	38	43075	43075	43075	43075	
22	Wheel Bearing Retainer (Left Hand)	-	—	43075	43075	43075	
23	Locking Wedge	39	—	—	—	—	
24	Gear – Differential (p/l)	48	43914	—	43914	—	
25	Lockwasher	51	—	—	—	—	
26	Screw – Flange Head	52	45720	45720	45720	45720	

(9) For selection thickness on 47560 and 48849 shims, see Differential Bearing Adjustment Shim Table at the end of the Ford section of this catalog.

Ford 1988-1998

Model 80 /286 Rear Axles for

E-350

F-350, F-450

Ford Model 80 /286 Rear Axles Exploded View

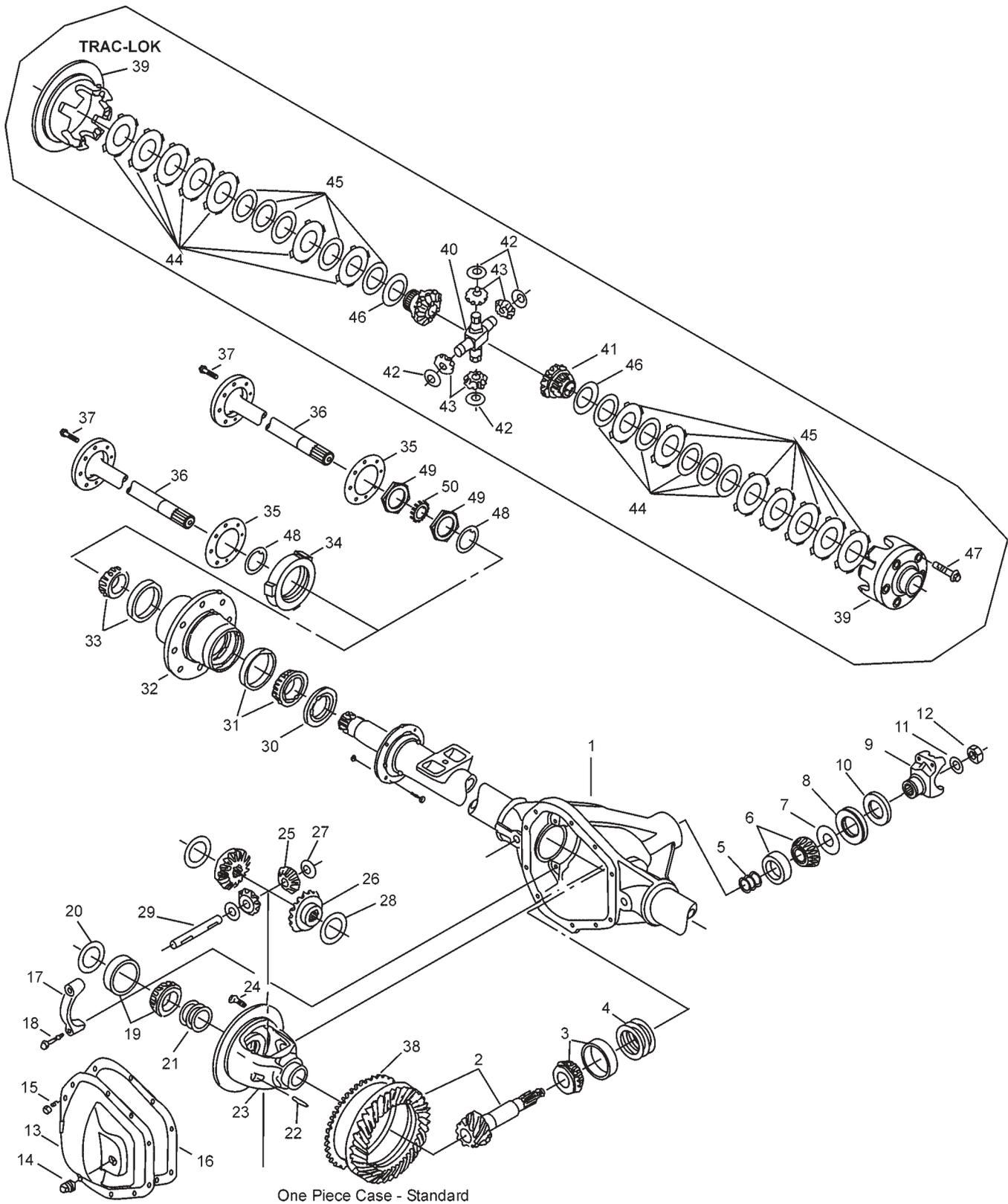

Ford Model 80 /286 Rear Axles Parts Listing

ITEM NO.	PART NUMBER	DESCRIPTION	ITEM NO.	PART NUMBER	DESCRIPTION
1	— ⁽³⁾	Housing – Axle Service	25	42413	Pinion – Differential (std)
2	— ⁽¹⁾	Drive Pinion & Gear Assembly	26	— ⁽²⁾	Gear – Differential (std)
3	— ⁽²⁾	KIT – Inner Pinion Bearing	27	35082	Thrustwasher – Diff Pinion (std)
	— ⁽²⁾	PKG – Pinion Bearing Shim (inc items 4, 5, 11, 12)	28	34729	Thrustwasher – Diff Gear (std)
	— ⁽²⁾	PKG – Diff & Pinion Bearing Shim (inc items 4, 5, 11, 12, 20)	29	46640	Shaft – Differential (std)
4	— ⁽⁴⁾	Inner Pinion Bearing Shims	30	— ⁽²⁾	Oil Seal (Inner Wheel)
5	— ⁽⁴⁾	Outer Pinion Bearing Shims	31	— ⁽²⁾	Bearing Cone – Inner Wheel
6	707064X	KIT – Outer Pinion Bearing	32	— ⁽³⁾	Bearing Cup – Inner Wheel
7	42430	Thrustwasher – Bearing	33	— ⁽²⁾	Hub & Rotor Assembly
8	46411	Seal – Pinion Oil	34	— ⁽³⁾	Bearing Cone – Outer Wheel
9	— ⁽²⁾	End Yoke Assembly (inc 10)	35	— ⁽²⁾	Bearing Cup – Outer Wheel
10	— ⁽²⁾	Slinger – End Yoke	36	— ⁽²⁾	Retainer – Wheel Bearing (RH)
11	37104	Washer – Pinion Nut	37	— ⁽¹⁾	Retainer – Wheel Bearing (LH)
12	37082	Pinion Nut	38	— ⁽²⁾	Gasket
	— ⁽²⁾	KIT – Carrier Cover (inc items 13, 14, 15)	39	— ⁽²⁾	Shaft – Axle
13	— ⁽²⁾	Carrier Cover	40	42414	Screw & Lockwasher Assembly
14	— ⁽²⁾	Plug – Carrier Cover	41	— ⁽⁴⁾	Tone Ring (ABS)
15	— ⁽²⁾	Bolt – Carrier Cover (qty 10)	42	— ⁽²⁾	Case – Differential (t/l)
16	38615	RTV Silicone Sealant	43	— ⁽²⁾	Shaft – Differential (t/l)
17	— ⁽³⁾	Differential Bearing Cap	44	— ⁽²⁾	Gear – Differential (t/l)
18	48632-1	Bolt – Differential Bearing Cap	45	— ⁽²⁾	Thrustwasher – Pinion (t/l)
19	706070X	KIT – Differential Bearing	46	— ⁽²⁾	Pinion – Differential (t/l)
20	— ⁽²⁾	KIT – Differential Outboard Spacer	47	— ⁽²⁾	KIT – Disc & Plate (t/l)
21	— ⁽²⁾	PKG – Differential Bearing Shim	48	— ⁽⁴⁾	Disc – Differential Clutch
22	47024	Lock – Differential Shaft	49	— ⁽⁴⁾	Plate – Differential Pressure
23	— ⁽⁴⁾	Case – Differential (std)	50	— ⁽⁴⁾	Disc – Differential Dished
24	42433	Bolt – Drive Gear (qty 12)		— ⁽²⁾	Bolt – Differential Case (t/l)
					Retainer Ring / O-Ring
					Spindle Nut
					Lockwasher – Spindle Nut

- (1) See "Bill of Material Table" on next page
(2) See "Variable Parts Table" within this section
(3) Contact Vehicle Manufacturer
(4) Not Sold Separately

Ford Model 80 /286 Rear Axles

Bill of Material Table

Axle			Axle Kits				Shaft & Joint Assy.	
Bill of Material	Diff. Type	Ratio	Ring Gear & Pinion Kit ⁽⁷⁾	Differential			Right Hand Shaft Assy.	Left Hand Shaft Assy.
				Case Assy. Kit ⁽⁸⁾	Case Kit	Inner Parts Kit		
1988 F-350 Super Duty								
605303-1	Standard	4.63	707060-1X	707061X	707062X	707063X	43286-1	43286-1
605303-2	Standard	5.13	707060-4X	707061X	707062X	707063X	43286-1	43286-1
605303-3	Standard	4.63	707060-1X	707061X	707062X	707063X	43286-1	43286-1
605303-4	Standard	5.13	707060-4X	707061X	707062X	707063X	43286-1	43286-1
1989 F-350 Super Duty								
605400-1	Standard	4.63	707060-1X	707061X	707062X	707063X	43286-1	43286-1
605400-2	Standard	5.13	707060-4X	707061X	707062X	707063X	43286-1	43286-1
1990-91 1/2 F-350 Super Duty								
605445-1	Standard	4.63	707060-1X	707184X	707062X	707185X	43651-1	43651-1
605445-2	Standard	5.13	707060-4X	707184X	707062X	707185X	43651-1	43651-1
1992-93 1/2 F-450 Chassis-DRW-Full Float								
605461-1	Standard	4.63	707060-1X	707232X	707230X	707185X	43651-1	43651-1
605461-2	Standard	5.13	707060-4X	707232X	707230X	707185X	43651-1	43651-1
1993-94 1/2 F-450 Chassis-DRW-Full Float								
605632-1	Standard	4.63	707060-1X	707232X	707230X	707185X	43651-1	43651-1
605632-2	Standard	5.13	707060-4X	707232X	707230X	707185X	43651-1	43651-1
1995-95 1/2 F-450 Chassis-DRW-Full Float								
605717-1	Standard	4.63	707060-12X	707232X	707230X	707185X	43651-1	43651-1
605717-2	Standard	5.13	707060-13X	707232X	707230X	707185X	43651-1	43651-1
1996 E-350 DRW Chassis - Full Float								
605834-1	Standard	4.63	707361-5X	707330X	707230X	707063X	46930-1	46930-2
1996-98 F-450 Chassis-DRW-Full Float								
605831-1	Standard	4.63	707361-5X	707394X	707395X	707185X	43651-1	43651-1
605831-2	Standard	5.13	707361-6X	707394X	707395X	707185X	43651-1	43651-1
605831-4	Trac Lok	5.13	707361-6X	708097	— ⁽³⁾	— ⁽³⁾	43651-1	43651-1
1997-98 E-350 DRW Chassis - Full Float								
605807-1	Standard	4.63	707361-5X	707330X	707230X	707063X	46930-1	46930-2
1998 1/2 E-350 Super Duty - DRW - Full Float								
606076-1	Standard	4.10	707361-11X	707330X	707230X	707063X	46930-1	46930-2
1998 1/2-99 1/2 F-350 Chassis DRW Full Float ABS								
605924-1	Standard	3.73	708120-5	707330X	707230X	707063X	47847-3	47847-4
605924-2	Trac Lok	4.10	708120-6	707477X	708053	708051	47847-3	47847-4
605924-3	Trac Lok	4.30	708120-7	707477X	708053	708051	47847-3	47847-4
605942-1	Trac Lok	4.10	708120-6	707477X	708053	708051	47847-1	47847-2
1998 1/2-99 1/2 F-450 Chassis-DRW-Full Float								
605925-1	Standard	4.88	708120-10	707394X	707395X	707185X	47852-1	47852-1
605925-2	Trac Lok	4.88	708120-10	708097	— ⁽³⁾	— ⁽³⁾	47852-1	47852-1
605925-3	Standard	5.38	708120-11	707394X	707395X	707185X	47852-1	47852-1
605925-4	Trac Lok	5.38	708120-11	708097	— ⁽³⁾	— ⁽³⁾	47852-1	47852-1
1998 1/2-2000 F-350 Pick-Up DRW-Full Float								
605926-1	Standard	3.73	708120-5	707330X	707230X	707063X	47847-1	47847-2
605926-2	Trac Lok	4.10	708120-6	707477X	708053	708051	47847-1	47847-2
605926-3	Trac Lok	4.30	708120-7	707477X	708053	708051	47847-1	47847-2

(3) Contact vehicle manufacturer

(7) See Ring Gear & Pinion Kits in XGI Catalog for ratio & tooth combinations.

(8) See Differential Case Assy Kits in XGI Catalog for spline data & ratios.

Ford Model 80 /286 Rear Axles Variable Parts Listing

Kits & Parts - Use With All Applications							
Description & Item Number (Refer to "Exploded View" at the front of this section)			Bills of Material				
			605303	605400 605445	605461	605632	605717
1	KIT – Inner Pinion Bearing	3	707065X	707065X	707065X	707065X	707065X
2	PKG – Pinion Bearing Shim	-	707066X	707066X	707066X	707066X	707066X
3	PKG – Diff & Pinion Bearing Shim	-	708036	708036	708036	708036	708036
4	End Yoke Assembly (inc 10)	9	3-4-11081-1X	3-4-11081-1X	3-4-11081-1X	3-4-11081-1X	3-4-11081-1X
5	Slinger – End Yoke	10	42432	42432	42432	42432	42432
6	KIT – Carrier Cover	-	707070X	707070X	707231X	707231X	707231X
7	Carrier Cover	13	42434	42434	42434	42434	42434
8	Plug – Carrier Cover	14	36472	36472	38637	38637	38637
9	Bolt – Carrier Cover (qty 10)	15	34822	34822	34822	34822	34822
10	KIT – Differential Outboard Spacer	20	707069X ⁽⁹⁾	707069X ⁽⁹⁾	707069X ⁽⁹⁾	707069X ⁽⁹⁾	707069X ⁽⁹⁾
11	PKG – Differential Bearing Shim	21	708035	708035	708035	708035	708035
12	Gear – Differential (std)	26	42411	43652	43652	43652	43652
13	Oil Seal (Inner Wheel)	30	42446	42446	44303	44303	44303
14	Bearing Cone – Inner Wheel	31	566025	566025	566025	565962	565962
15	Bearing Cone – Outer Wheel	33	565907	565907	565907	566057	566057
16	Retainer – Wheel Bearing (RH)	34	43075	43075	—	—	46471
17	Retainer – Wheel Bearing (LH)	-	43076	43076	—	—	46471
18	Gasket	35	42445	42445	45817	45817	42445
19	Screw & Lockwasher Assembly	37	42447	42447	45816	45816	45816
20	Shaft – Differential (t/l)	40	—	—	—	—	—
21	Gear – Differential (t/l)	41	—	—	—	—	—
22	Thrustwasher – Pinion (t/l)	42	—	—	—	—	—
23	Pinion – Differential (t/l)	43	—	—	—	—	—
24	KIT – Disc & Plate (t/l)	-	—	—	—	—	—
25	Bolt – Differential Case (t/l)	47	—	—	—	—	—
26	Retainer Ring / O-Ring	48	—	—	36637	36637	—
27	Spindle Nut	49	—	—	36635	36635	—
28	Lockwasher – Spindle Nut	50	—	—	36636	36636	—

(See next page for additional bills of material)

- (9) 701133X & 707069X contain bearing preload spacers which can be purchased separately. See Differential Bearing Adjustment Shim Table, at the back of the Ford section of this catalog, for thickness applications. The bearing cone spacer (44849) can be purchased separately in kit 701152X.

Ford Model 80 /286 Rear Axles Variable Parts Listing

Kits & Parts - Use With All Applications							
Description & Item Number (Refer to "Exploded View" at the front of this section)			Bills of Material				
			605807	605831	605834	605924	605925
1	KIT – Inner Pinion Bearing	3	707065X	707065X	707065X	707447X	707447X
2	PKG – Pinion Bearing Shim	-	707066X	707066X	707066X	707480X	707480X
3	PKG – Diff & Pinion Bearing Shim	-	707365X	707365X	707365X	707481X	707481X
4	End Yoke Assembly (inc 10)	9	75725X	3-4-11081-1X	75725X	3-4-11081-1X	3-4-11281-1X
5	Slinger – End Yoke	10	42432	42432	42432	231872	231872
6	KIT – Carrier Cover	-	707231X	707231X	707231X	707479X	707478X
7	Carrier Cover	13	42434	42434	42434	47717-1	47843
8	Plug – Carrier Cover	14	38637	38637	38637	38637	38637
9	Bolt – Carrier Cover (qty 10)	15	34822	34822	34822	34822	47508
10	KIT – Differential Outboard Spacer	20	701133X ⁽⁹⁾	701133X ⁽⁹⁾	701133X ⁽⁹⁾	701133X ⁽⁹⁾	701133X ⁽⁹⁾
11	PKG – Differential Bearing Shim	21	707364X	707364X	707364X	707364X	707364X
12	Gear – Differential (std)	26	42411	43652	42411	42411	43652
13	Oil Seal (Inner Wheel)	30	47507	44303	47507	47507	47860
14	Bearing Cone – Inner Wheel	31	565906	565962	565906	565906	566071
15	Bearing Cone – Outer Wheel	33	565911	566057	565911	565911	550348
16	Retainer – Wheel Bearing (RH)	34	43075	46471	43075	43075	47858
17	Retainer – Wheel Bearing (LH)	-	43075	46471	43075	43075	47858
18	Gasket	35	39697	42445	39697	—	—
19	Screw & Lockwasher Assembly	37	45720	45816	45720	45816	45816
20	Shaft – Differential (t/l)	40	—	—	—	47802	—
21	Gear – Differential (t/l)	41	—	—	—	47796	—
22	Thrustwasher – Pinion (t/l)	42	—	—	—	47800	—
23	Pinion – Differential (t/l)	43	—	—	—	47798	—
24	KIT – Disc & Plate (t/l)	-	—	—	—	702009	—
25	Bolt – Differential Case (t/l)	47	—	—	—	41610-1	—
26	Retainer Ring / O-Ring	48	—	—	—	47893	47857
27	Spindle Nut	49	—	—	—	—	—
28	Lockwasher – Spindle Nut	50	—	—	—	—	—

(See next page for additional bills of material)

(9) 701133X & 707069X contain bearing preload spacers which can be purchased separately. See Differential Bearing Adjustment Shim Table, at the back of the Ford section of this catalog, for thickness applications. The bearing cone spacer (44849) can be purchased separately in kit 701152X.

Ford Model 80 /286 Rear Axles Variable Parts Listing

Kits & Parts - Use With All Applications						
Description & Item Number (Refer to "Exploded View" at the front of this section)			Bills of Material			
			605926	605942	605944	606076
1	KIT – Inner Pinion Bearing	3	707447X	707447X	707447X	707065X
2	PKG – Pinion Bearing Shim	-	707480X	707480X	707480X	707066X
3	PKG – Diff & Pinion Bearing Shim	-	707481X	707481X	707481X	707365X
4	End Yoke Assembly (inc 10)	9	3-4-11081-1X	3-4-11081-1X	3-4-11281-1X	75725X
5	Slinger – End Yoke	10	231872	231872	231872	42432
6	KIT – Carrier Cover	-	707479X	707479X	707478X	707231X
7	Carrier Cover	13	47717-1	47717-1	47843	42434
8	Plug – Carrier Cover	14	38637	38637	38637	38637
9	Bolt – Carrier Cover (qty 10)	15	34822	34822	34822	34822
10	KIT – Differential Outboard Spacer	20	701133X ⁽⁹⁾	701133X ⁽⁹⁾	701133X ⁽⁹⁾	701133X ⁽⁹⁾
11	PKG – Differential Bearing Shim	21	707364X	707364X	707364X	707364X
12	Gear – Differential (std)	26	42411	—	43652	42411
13	Oil Seal (Inner Wheel)	30	47507	47507	47860	47507
14	Bearing Cone – Inner Wheel	31	565906	565906	566071	565906
15	Bearing Cone – Outer Wheel	33	565911	565911	550348-1	565911
16	Retainer – Wheel Bearing (RH)	34	43075	43075	47858	43075
17	Retainer – Wheel Bearing (LH)	-	43075	43075	47858	43075
18	Gasket	35	—	—	—	39697
19	Screw & Lockwasher Assembly	37	45816	45816	45816	45720
20	Shaft – Differential (t/l)	40	47802	47802	—	—
21	Gear – Differential (t/l)	41	47796	47796	—	—
22	Thrustwasher – Pinion (t/l)	42	47800	47800	—	—
23	Pinion – Differential (t/l)	43	47798	47798	—	—
24	KIT – Disc & Plate (t/l)	-	702009	702009	—	—
25	Bolt – Differential Case (t/l)	47	41610-1	41610-1	—	—
26	Retainer Ring / O-Ring	48	47893	47893	47857	—
27	Spindle Nut	49	—	—	—	—
28	Lockwasher – Spindle Nut	50	—	—	—	—

- (9) 701133X & 707069X contain bearing preload spacers which can be purchased separately. See Differential Bearing Adjustment Shim Table, at the back of the Ford section of this catalog, for thickness applications. The bearing cone spacer (44849) can be purchased separately in kit 701152X.

Ford Optional Camber/Caster Bushing Chart

Ford 28 IFS Front Optional Camber/Caster Bushing Chart (round)

CASTER			CAMBER			Part Number	Color
Amount of Caster Correction	Right Side	Left Side	Amount of Camber Correction	Right Side	Left Side		
0° 00'	none	none	0 00'	none	none	40218	none
0° 00'	none	none	1 00'	positive (1) negative (2)	positive (1) negative (2)	42981	
1° 00'	positive	do not use	1 00'	positive (1) negative (2)	do not use	43182	

(1) Arrow out

(2) Arrow in

Ford 28 IFS and 35 IFS Front Optional Camber/Caster Bushing Chart (hexagonal)

Amount of Caster Correction	Right Side	Left Side	Amount of Camber Correction	Part Number	Color
0° 00'	none	none	0 00'	43918	Black
0° 00'	none	none	0 30'	43592	Green
0° 00'	none	none	1 00'	43919	Red
0° 00'	none	none	1 30'	43920	Blue

No Arrows

Ford 44 IFS and 50 IFS Front Optional Camber/Caster Bushing Chart

CASTER			CAMBER			Part Number	Color
Amount of Caster Correction	Right Side	Left Side	Amount of Camber Correction	Right Side	Left Side		
0° 00'	none	none	0 30'	none	none	42229	none
0° 00'	none	none	1 00'	none	none	43149	Red
0° 00'	none	none	1 30'	none	none	43579	Blue
0° 30'			0 54'	positive (1) negative (2)	positive (1) negative (2)	46580	Black
0° 30'			1 24'	positive (1) negative (2)	positive (1) negative (2)	46579	Yellow

(1) Arrow out

(2) Arrow in

Ford 50 and 60 Front Optional Camber/Caster Bushing Chart

Amount of Caster Correction	Right Side	Left Side	Amount of Camber Correction	Part Number	Color
0° 00'	none	none	0 00'	44507	Black
0° 30'	positive	negative	0 00'	44508	Red
0° 30'	negative	positive	0 00'	44509	Blue
0° 45'	positive	none	0 00'	44510	Green
0° 45'	negative	positive	0 00'	44511	Yellow
0° 00'	positive	negative	0 30'	50421	Pink
0° 30'	negative	positive	0 30'	50422	Orange

No Arrows

Notes: The camber can be used for both positive and negative applications, unless otherwise noted. For negative camber, point the arrow on the camber adjuster inboard. OPT is for optional bushing.

Ford Differential Bearing Adjustment Shims



Model 60 Rear & 70 Rear

Part Number	Nominal		Manufacturing Limits	
	MM	Inch	MM	Inch
47560-241	2.41	0.095	2.400/2.423	0.0945/0.0954
47560-254	2.54	0.100	2.527/2.550	0.0995/0.1004
47560-267	2.67	0.105	2.654/2.677	0.1045/0.1054
47560-279	2.79	0.110	2.791/2.804	0.1095/0.1104
47560-292	2.92	0.115	2.908/2.931	0.1145/0.1154
47560-305	3.05	0.120	3.035/3.058	0.1195/0.1204
47560-318	3.18	0.125	3.162/3.185	0.1245/0.1254
47560-330	3.30	0.130	3.289/3.312	0.1295/0.1304
47560-343	3.43	0.135	3.416/3.439	0.1345/0.1354
47560-356	3.56	0.140	3.543/3.566	0.1395/0.1404
47560-368	3.68	0.145	3.670/3.693	0.1445/0.1454
47560-381	3.81	0.150	3.797/3.820	0.1495/0.1504
47560-394	3.94	0.155	3.924/3.947	0.1545/0.1554
47560-406	4.06	0.160	4.051/4.074	0.1595/0.1604
47560-419	4.19	0.165	4.178/4.201	0.1645/0.1654
47560-432	4.32	0.170	4.305/4.328	0.1695/0.1704
47560-445	4.45	0.175	4.432/4.455	0.1745/0.1754
47560-457	4.57	0.180	4.559/4.582	0.1795/0.1804

Model 70 Rear

Part Number	Nominal		Manufacturing Limits	
	MM	Inch	MM	Inch
48849-457	4.57	0.180	4.559/4.582	0.1795/0.1804
48849-470	4.70	0.185	4.686/4.709	0.1845/0.1854
48849-483	4.83	0.190	4.813/4.836	0.1895/0.1904
48849-495	4.95	0.195	4.940/4.963	0.1945/0.1954
48849-508	5.08	0.200	5.067/5.090	0.1995/0.2004
48849-521	5.21	0.205	5.194/5.217	0.2045/0.2054
48849-533	5.33	0.210	5.321/5.344	0.2095/0.2104
48849-546	5.46	0.215	5.448/5.471	0.2145/0.2154
48849-559	5.59	0.220	5.575/5.598	0.2195/0.2204
48849-572	5.72	0.225	5.702/5.725	0.2245/0.2254
48849-584	5.84	0.230	5.829/5.852	0.2295/0.2304
48849-597	5.97	0.235	5.956/5.979	0.2345/0.2354
48849-610	6.10	0.240	6.083/6.106	0.2395/0.2404
48849-622	6.22	0.245	6.210/6.233	0.2445/0.2454
48849-635	6.35	0.250	6.237/6.360	0.2495/0.2504
48849-648	6.48	0.255	6.464/6.487	0.2545/0.2554

Model 80 Rear

Part Number	Nominal		Manufacturing Limits	
	MM	Inch	MM	Inch
44848-1	4.61	0.181	4.623/4.597	0.1820/0.1810
44848-2	4.65	0.183	4.661/4.636	0.1835/0.1825
44848-3	4.69	0.185	4.699/4.674	0.1850/0.1840
44848-4	4.72	0.186	4.737/4.712	0.1865/0.1855
44848-5	4.76	0.188	4.775/4.750	0.1880/0.1870
44848-6	4.80	0.189	4.813/4.788	0.1895/0.1885
44848-7	4.84	0.191	4.851/4.826	0.1850/0.1900
44848-8	4.88	0.192	4.890/4.864	0.1910/0.1915
44848-9	4.91	0.194	4.928/4.902	0.1940/0.1930
44848-10	4.95	0.195	4.966/4.940	0.1955/0.1945
44848-11	4.99	0.197	5.004/4.978	0.1970/0.1960
44848-12	5.03	0.198	5.042/5.017	0.1985/0.1975
44848-13	5.07	0.200	5.085/5.055	0.2000/0.1990
44848-14	5.11	0.201	5.118/5.093	0.2015/0.2005
44848-15	5.14	0.203	5.156/5.131	0.2030/0.2020
44848-16*	5.18	0.204	5.494/5.169	0.2045/0.2035
44848-17	5.22	0.205	5.232/5.207	0.2006/0.2050
44848-18*	5.26	0.207	5.271/5.245	0.2075/0.2065
44848-20*	5.33	0.210	5.347/5.321	0.2105/0.2095
44848-21	5.37	0.211	5.385/5.359	0.2120/0.2110
44848-22*	5.41	0.213	5.423/5.398	0.2135/0.2125
44848-23	5.45	0.215	5.461/5.436	0.2150/0.2140
44848-24*	5.41	0.216	5.499/5.474	0.2165/0.2155
44848-25	5.57	0.218	5.537/5.512	0.2180/0.1170
44848-26*	5.51	0.219	5.575/5.550	0.2195/0.2185
44848-27	5.67	0.221	5.613/5.588	0.2210/0.1200
44848-28*	5.61	0.222	5.652/5.626	0.2225/0.2215
44848-29	5.67	0.224	5.690/5.664	0.2240/0.1230
44848-30*	5.71	0.225	5.728/5.702	0.2255/0.2245
44848-31	5.77	0.227	5.766/5.740	0.2270/0.1260
44848-32*	5.71	0.228	5.804/5.779	0.2285/0.2275
44848-33	5.87	0.230	5.842/5.817	0.2300/0.1290
44848-34*	5.81	0.231	5.880/5.855	0.2315/0.2305
44848-35	5.97	0.233	5.918/5.893	0.2330/0.1320
44848-36*	5.91	0.234	5.956/5.931	0.2345/0.2335
44848-37	5.97	0.235	5.994/5.969	0.2360/0.1350
44848-38*	6.01	0.237	6.033/6.007	0.2375/0.2365
44848-39	6.01	0.238	6.071/6.045	0.2395/0.2385
44848-40*	6.11	0.240	6.109/6.083	0.2405/0.2395
44848-41	6.13	0.241	6.147/6.121	0.2420/0.2410

* Included in Kit 701133X

GM / Chevrolet 1978-1980

Model 44 /216 Front Axles for

Blazer, K-10 and K-20

GM Model 44 /216 Front Axles Parts Listing



ITEM NO.	PART NUMBER	DESCRIPTION	ITEM NO.	PART NUMBER	DESCRIPTION
1	— ⁽³⁾	Housing – Axle Service		— ⁽²⁾	KIT – Left Knuckle Assembly (inc 32,33,34,35,36,37,38,39,43)
2	— ⁽¹⁾	Drive Pinion & Gear Assembly			
3	30764 ⁽⁵⁾	Slinger – Inner Pinion Bearing		706116X	KIT – Socket Assembly
4	706031X	KIT – Inner Pinion Bearing	32	44101	Nut – Hex Slotted
	706376X	PKG – Diff & Pinion Bearing Shim (inc items 5, 7, 13, 16, 22)	33	500024-6	Cotter Pin
	706358X	PKG – Pinion Bearing Shim (inc items 5, 7, 13, 16)	34	35417	Adjusting Split Ring
5	—	Inner Pinion Adj Shims (see shim packages)	35	40112	Socket Assembly – Upper
			36	35566	Lock Nut
6	30765 ⁽⁵⁾	Baffle – Pinion Bearing	37	40113	Socket Assembly – Lower
7	—	Outer Pinion Bearing Shims (see shim packages)	38	35928	Snap Ring
			39	— ⁽²⁾	Bolt – Hex (qty 6)
8	706030X	KIT – Outer Pinion Bearing	40	31026-1	Stop Screw
9	13575	Slinger – Outer Pinion Bearing	41	500381-3	Jam Nut
10	39118	Seal – Pinion Oil	42	620260	Right Knuckle
11	2-4-5331X	End Yoke Assembly (inc 12)	43	620261	Left Knuckle
12	15099	Slinger – End Yoke	44	— ⁽³⁾	Nut – Hex Slotted
13	30186	Washer – Pinion Nut	45	— ⁽³⁾	Cotter Pin
14	30185	Pinion Nut	46	— ⁽³⁾	Tie Rod Assembly
	706112X	KIT – Carrier Cover (15, 16, 17, 18)	47	— ⁽¹⁾	Shaft & Joint Assembly
15	39015	Carrier Cover	48	36364	Slinger – Spindle Yoke
16	34685	Gasket – Carrier Cover		706527X	KIT – Spindle Seal & Bearing
17	36472	Plug – Carrier Cover	49	706570X	KIT – Spindle (inc 49, 50, 51, 52, 53)
18	34279	Bolt – Carrier Cover		38128	Oil Seal
19	— ⁽³⁾	Differential Bearing Cap	50	36361	Oil Seal (block vee)
20	48632-1	Bolt – Differential Bearing Cap	51	38106	Spacer – Wheel Bearing Spindle
21	706032X	KIT – Differential Bearing	52	550759	Needle Bearing Assembly
22	706086X	PKG – Diff Bearing Shim (inc 16)	53	38428	Spindle – Wheel Bearing
23	— ⁽⁴⁾	Case – Differential (std)	54	— ⁽³⁾	Nut – Brake Mounting
24	41221	Bolt – Drive Gear (qty 10)	55	36366	Oil Seal
25	40194	Gear – Differential (std)	56	706074X	KIT – Inner Wheel Bearing
26	17717	Pinion – Differential (std)	57	— ⁽³⁾	Wheel Hub
27	13338-3	Thrustwasher – Diff Pinion (std)	58	706111X	KIT – Outer Wheel Bearing
28	32121	Thrustwasher – Diff Gear (std)	59	21588X	Nut & Pin Assembly – Inner Lock
29	39194	Shaft – Differential (std)	60	36569	Lock Nut
30	13449	Lock – Differential Shaft	61	31139	Nut – Wheel Bearing Adjusting
31	620216	Seal & Guide Tube	62	32589	Plate – Spring Retaining
	— ⁽²⁾	KIT – Right Knuckle Assembly (inc 32,33,34,35,36,37,38,39,42)	63	35218	Spring – Pressure
			64	42667	Gear – Axle Drive
			65	31624	Snap Ring
			66	44328	Hub Cap

- (1) See "Bill of Material Table" on next page
- (2) See "Variable Parts Table" below
- (3) Contact Vehicle Manufacturer
- (4) Not Sold Separately
- (5) Inner Slinger & Pinion Baffle may be included in Ring & Pinion Kit. Use only if axle being rebuilt has them also.

Variable Parts Listing

Kits & Parts - Use With All Applications					
Description & Item Number (Refer to "Exploded View" on the previous page)			Bills of Material		
			610054 610055 610056	610079 610080 610081	
1	KIT – Right Knuckle Assembly	-	700076	700141	
2	KIT – Left Knuckle Assembly	-	700077	700142	
3	Bolt – Hex (qty 6)	39	36326-4	36326-2	

GM Model 44 /216 Front Axles

Bill of Material Table

Axle			Axle Kits				Shaft & Joint Assy.	
Bill of Material	Diff. Type	Ratio	Ring Gear & Pinion Kit ⁽⁷⁾	Differential			Right Hand Shaft Assy.	Left Hand Shaft Assy.
				Case Assy. Kit ⁽⁸⁾	Case Kit	Inner Parts Kit		
1978-79 K-20								
610055-1	Standard	3.73	706017-4X	706020X	706024X	706027X	29833-1X	29833-2X
610055-2	Standard	3.73	706017-4X	706020X	706024X	706027X	29833-1X	29833-2X
610055-3	Standard	4.09	706017-5X	706021X	706025X	706027X	29833-1X	29833-2X
610055-4	Standard	4.09	706017-5X	706021X	706025X	706027X	29833-1X	29833-2X
1979 Blazer & K-10								
610054-1	Standard	2.72	706017-19X	706020X	706024X	706027X	29833-1X	29833-2X
610054-2	Standard	2.72	706017-19X	706020X	706024X	706027X	29833-1X	29833-2X
610054-3	Standard	3.07	706017-1X	706020X	706024X	706027X	29833-1X	29833-2X
610054-4	Standard	3.07	706017-1X	706020X	706024X	706027X	29833-1X	29833-2X
610054-5	Standard	3.42	700025-3	706020X	706024X	706027X	29833-1X	29833-2X
610054-6	Standard	3.42	700025-3	706020X	706024X	706027X	29833-1X	29833-2X
610054-7	Standard	3.73	706017-4X	706020X	706024X	706027X	29833-1X	29833-2X
610054-8	Standard	3.73	706017-4X	706020X	706024X	706027X	29833-1X	29833-2X
610054-9	Standard	4.09	706017-5X	706021X	706025X	706027X	29833-1X	29833-2X
610054-10	Standard	4.09	706017-5X	706021X	706025X	706027X	29833-1X	29833-2X
1979 K-20								
610056-1	Standard	3.73	706017-4X	706020X	706024X	706027X	29833-1X	29833-2X
610056-2	Standard	3.73	706017-4X	706020X	706024X	706027X	29833-1X	29833-2X
610056-3	Standard	4.09	706017-5X	706021X	706025X	706027X	29833-1X	29833-2X
610056-4	Standard	4.09	706017-5X	706021X	706025X	706027X	29833-1X	29833-2X
1979-80 K-20								
610080-1	Standard	3.73	706017-4X	706020X	706024X	706027X	29833-1X	29833-2X
610080-2	Standard	3.73	706017-4X	706020X	706024X	706027X	29833-1X	29833-2X
610080-3	Standard	4.09	706017-5X	706021X	706025X	706027X	29833-1X	29833-2X
610080-4	Standard	4.09	706017-5X	706021X	706025X	706027X	29833-1X	29833-2X
610080-5	Standard	3.23	706017-16X	706020X	706024X	706027X	29833-1X	29833-2X
610080-6	Standard	3.42	700025-3	706020X	706024X	706027X	29833-1X	29833-2X
610081-1	Standard	3.73	706017-4X	706020X	706024X	706027X	29833-1X	29833-2X
610081-2	Standard	3.73	706017-4X	706020X	706024X	706027X	29833-1X	29833-2X
610081-3	Standard	4.09	706017-5X	706021X	706025X	706027X	29833-1X	29833-2X
610081-4	Standard	4.09	706017-5X	706021X	706025X	706027X	29833-1X	29833-2X
610081-5	Standard	3.23	706017-16X	706020X	706024X	706027X	29833-1X	29833-2X
610081-6	Standard	3.42	700025-3	706020X	706024X	706027X	29833-1X	29833-2X
610081-7	Standard	4.55	706017-6X	706021X	706025X	706027X	29833-1X	29833-2X
1980 K-20								
610079-1	Standard	2.72	706017-19X	706020X	706024X	706027X	29833-1X	29833-2X
610079-2	Standard	2.72	706017-19X	706020X	706024X	706027X	29833-1X	29833-2X
610079-3	Standard	3.07	706017-1X	706020X	706024X	706027X	29833-1X	29833-2X
610079-4	Standard	3.07	706017-1X	706020X	706024X	706027X	29833-1X	29833-2X
610079-5	Standard	3.42	700025-3	706020X	706024X	706027X	29833-1X	29833-2X
610079-6	Standard	3.42	700025-3	706020X	706024X	706027X	29833-1X	29833-2X
610079-7	Standard	3.73	706017-4X	706020X	706024X	706027X	29833-1X	29833-2X
610079-8	Standard	3.73	706017-4X	706020X	706024X	706027X	29833-1X	29833-2X
610079-9	Standard	4.09	706017-5X	706021X	706025X	706027X	29833-1X	29833-2X
610079-10	Standard	4.09	706017-5X	706021X	706025X	706027X	29833-1X	29833-2X

(7) See Ring Gear & Pinion Kits in XGI Catalog for ratio & tooth combinations.

(8) See Differential Case Assy Kits in XGI Catalog for spline data & ratios.

GM / Chevrolet 1979-1991 1/2
Model 60 /248 Front Axles for
CUCV, K-30 and V-30

GM Model 60 /248 Front Axles Exploded View

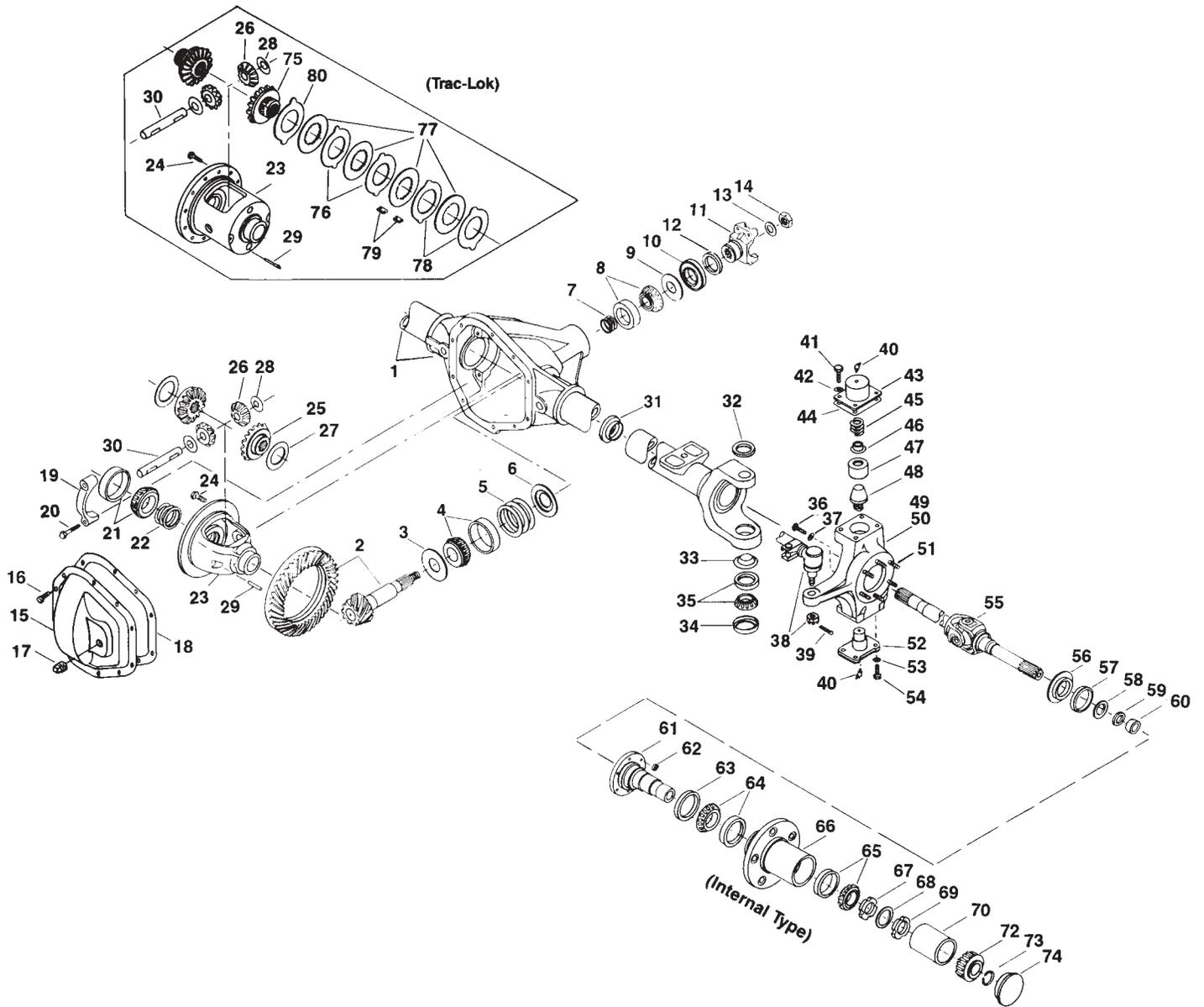

GM Model 60 /248 Front Axles Parts Listing

ITEM NO.	PART NUMBER	DESCRIPTION	ITEM NO.	PART NUMBER	DESCRIPTION
1	— ⁽³⁾	Housing – Axle Service	41	30875	Nut – Hex Tapered
2	— ⁽¹⁾	Drive Pinion & Gear Assembly	42	—	Lockwasher (King Pin Cap – Upper)
3	34643 ⁽⁵⁾	Slinger – Inner Pinion Bearing	43	38139	Steering Arm (LH only)
4	706046X	KIT – Inner Pinion Bearing		620132	King Pin Cap – Upper (RH only)
5	—	Inner Pinion Bearing Shims (see shim packages)	44	37307	Gasket – King Pin Cap
	706375X	PKG – Diff & Pinion Bearing Shim (inc items 4, 6, 13, 18, 22)	45	37300	Spring – Pressure
6	30982 ⁽⁵⁾	Baffle – Pinion Bearing	46	620180	Spring Retainer
	706359X	PKG – Pinion Bearing Shim (inc items 4, 6, 13, 18)	47	41886	Bushing – King Pin
	—	Outer Pinion Bearing Shims (see shim packages)	48	37302	King Pin
7	—	Outer Pinion Bearing Shims (see shim packages)	49	41893	KIT – Right Knuckle Assy (49, 51)
8	706045X	KIT – Outer Pinion Bearing	50	41894	KIT – Left Knuckle Assy (50, 51)
9	42737	Thrustwasher – Bearing	51	37879	Right Knuckle
10	42449	Seal – Pinion Oil	52	37299	Left Knuckle
11	2-4-3801-1X	End Yoke Assembly (inc 12) Bearing strap kit used w/end yoke	53	500357-13	Bolt – Hex
12	34592	Slinger – End Yoke	54	500412-13	King Pin Bearing Cap – Lower
13	30275	Washer – Pinion Nut	55	— ⁽¹⁾	Lockwasher (King Pin Cap – Lower)
14	30271	Pinion Nut	56	37308	Bolt – Hex (King Pin Cap – Lower)
	— ⁽²⁾	KIT – Carrier Cover (inc items 15, 16, 17)		700014	Shaft & Joint Assembly
15	— ⁽²⁾	Carrier Cover		— ⁽²⁾	Slinger – Spindle Yoke
16	34822	Bolt – Carrier Cover (qty 10)	57	37311	KIT – Spindle Seal & Bearing (inc items 57, 58, 59, 60)
17	— ⁽²⁾	Plug – Carrier Cover	58	37312	KIT – Spindle (inc items 57, 58, 59, 60, 61)
18	34687	Gasket – Carrier Cover	59	620062	Oil Seal
19	—	Differential Bearing Cap	60	620063	Spacer – Wheel Bearing Spindle
20	48632-1	Bolt – Differential Bearing Cap	61	— ⁽²⁾	Oil Seal (Block-Vee)
21	706047X	KIT – Differential Bearing	62	36880	Needle Bearing Assembly
22	706378X	PKG – Diff Differential Shim (inc 18)	63	48816	Spindle – Wheel Bearing
23	— ⁽⁴⁾	Case – Differential	64	706411X	Nut – Brake Mounting
24	30266	Bolt – Drive Gear (qty 12)	65	706074X	Oil Seal
25	35625	Gear – Differential (std)	66	— ⁽³⁾	KIT – Inner Wheel Bearing
26	34367	Pinion – Differential	67	— ⁽²⁾	KIT – Outer Wheel Bearing
27	34729	Thrustwasher – Diff Gear (std)	68	— ⁽²⁾	Wheel Hub
28	34730	Thrustwasher – Diff Pinion (std)	69	— ⁽²⁾	Nut & Pin Assembly
29	44810	Lock – Differential Shaft	70	— ⁽²⁾	Lockwasher – Wheel Bearing Nut
30	30263	Shaft – Differential	71	— ⁽²⁾	Spindle Nut
31	36487	Seal & Guide Tube	72	37730	Spacer
	706395X	KIT – King Pin Parts (inc items 32, 33, 34, 35)	73	— ⁽²⁾	Gear – Axle Drive
32	620058	King Pin Seal – Upper	N.I.	—	Snap Ring
33	37305	Grease Retainer		— ⁽²⁾	Hub Cap
34	706150X	KIT – King Pin Bearing – Lower		— ⁽³⁾	Key – Square
35	41777	Oil Seal		— ⁽³⁾	Hub Lock Assembly
36	31026-1	Stop Screw	75	35830	Gear – Differential (t/l)
37	500381-3	Jam Nut		707083X	KIT – Differential Plate & Disc (t/l) (inc items 76, 77, 78, 79, 80)
38	— ⁽³⁾	Tie Rod Assembly	76	— ⁽⁴⁾	Plate – Differential Pressure
39	— ⁽³⁾	Cotter Pin	77	— ⁽⁴⁾	Disc – Differential
40	500175-1	Lube Fitting	78	— ⁽⁴⁾	Plate – Differential
			79	40835	Clip – Differential Clutch
			80	— ⁽⁴⁾	Spacer – Plate Preload

(1) See "Bill of Material Table" on next page

(2) See "Variable Parts Table" within this section

(3) Contact Vehicle Manufacturer

(4) Not Sold Separately

(5) Inner Slinger & Pinion Baffle may be included in Ring & Pinion Kit. Use only if axle being rebuilt has them also.

GM Model 60 /248 Front Axles

Bill of Material Table

Axle			Axle Kits				Shaft & Joint Assy.	
Bill of Material	Diff. Type	Ratio	Ring Gear & Pinion Kit ⁽⁷⁾	Differential			Right Hand Shaft Assy.	Left Hand Shaft Assy.
				Case Assy. Kit ⁽⁸⁾	Case Kit	Inner Parts Kit		
1979-80 K-30								
610057-1	Standard	4.10	706033-3X	706180X	706040X	706702X	907967-5	907967-6
610057-2	Standard	4.10	706033-3X	706180X	706040X	706702X	907967-5	907967-6
610057-3	Standard	4.56	706033-4X	706182X	706041X	706702X	907967-5	907967-6
610057-4	Standard	4.56	706033-4X	706182X	706041X	706702X	907967-5	907967-6
610057-5	Standard	4.10	706033-3X	706180X	706040X	706702X	907967-5	907967-6
610057-7	Standard	4.56	706033-4X	706182X	706041X	706702X	907967-5	907967-6
610057-8	Standard	4.10	706033-3X	706180X	706040X	706702X	907967-5	907967-6
1981 K-30								
610132-1	Standard	4.10	706033-3X	706180X	706040X	706702X	907967-5	907967-6
610132-2	Standard	4.56	706033-4X	706182X	706041X	706702X	907967-5	907967-6
610132-3	Standard	4.10	706033-3X	706180X	706040X	706702X	907967-5	907967-6
610132-4	Standard	4.56	706033-4X	706182X	706041X	706702X	907967-5	907967-6
610132-5	Standard	3.73	706033-2X	706180X	706040X	706702X	907967-5	907967-6
610132-6	Standard	3.73	706033-2X	706180X	706040X	706702X	907967-5	907967-6
1982-87 K-30								
610159-1	Standard	4.10	706033-3X	706180X	706040X	706702X	907967-5	907967-6
610159-2	Standard	4.56	706033-4X	706182X	706041X	706702X	907967-5	907967-6
610159-3	Standard	4.10	706033-3X	706180X	706040X	706702X	907967-5	907967-6
610159-4	Standard	4.56	706033-4X	706182X	706041X	706702X	907967-5	907967-6
610159-5	Standard	3.73	706033-2X	706180X	706040X	706702X	907967-5	907967-6
610159-6	Standard	3.73	706033-2X	706180X	706040X	706702X	907967-5	907967-6
1984-85 K-30								
610202-1	Standard	3.73	706033-2X	706180X	706040X	706702X	907967-5	907967-6
610202-2	Standard	3.73	706033-2X	706180X	706040X	706702X	907967-5	907967-6
610202-3	Standard	4.10	706033-3X	706180X	706040X	706702X	907967-5	907967-6
610202-4	Standard	4.10	706033-3X	706180X	706040X	706702X	907967-5	907967-6
610202-5	Standard	4.56	706033-4X	706182X	706041X	706702X	907967-5	907967-6
610202-6	Standard	4.56	706033-4X	706182X	706041X	706702X	907967-5	907967-6
1984-88 CUCV								
610201-1	Standard	4.56	706033-4X	706182X	706041X	706702X	907967-5	907967-6
610201-2	Trac Lok	4.56	706033-4X	707097-4X	706039X	707086X	907967-5	907967-6
1988-91 1/2 V-30								
610295-1	Standard	4.10	706033-3X	706180X	706040X	706702X	907967-5	907967-6
610295-2	Standard	4.56	706033-4X	706182X	706041X	706702X	907967-5	907967-6
610295-3	Standard	4.10	706033-3X	706180X	706040X	706702X	907967-5	907967-6
610295-4	Standard	4.56	706033-4X	706182X	706041X	706702X	907967-5	907967-6
610295-5	Standard	3.73	706033-2X	706180X	706040X	706702X	907967-5	907967-6
610295-6	Standard	3.73	706033-2X	706180X	706040X	706702X	907967-5	907967-6

(7) See Ring Gear & Pinion Kits in XGI Catalog for ratio & tooth combinations.
(8) See Differential Case Assy Kits in XGI Catalog for spline data & ratios.

GM Model 60 /248 Front Axles Variable Parts Listing

Kits & Parts - Use With All Applications							
Description & Item Number (Refer to "Exploded View" at the front of this section)			Bills of Material				
			610057	610132	610159	610201	610202
1	KIT – Carrier Cover	-	706128X	707233X	707233X	706968X	707233X
2	Carrier Cover	15	34675	43600-1	43600-1	43797	43600-1
3	Plug – Carrier Cover	17	36472	43180	43180	43180	43180
4	KIT – Spindle	-	700013	700013	700013	706979X	706979X
5	Spindle – Wheel Bearing	61	620061	620061	620061	40950	40950
6	Nut & Pin Assembly	67	—	—	660568	660568	—
7	Lockwasher – Wheel Bearing Nut	68	33733	33733	621028	621028	—
8	Spindle Nut	69	33732	33732	621027	621027	40951
9	Spacer	70	37997	37997	—	—	—
10	Gear – Axle Drive	71	37994	37994	—	—	—
11	Hub Cap	73	37996	—	—	—	—
			610295				
1	KIT – Carrier Cover	-	707233X				
2	Carrier Cover	15	43600-1				
3	Plug – Carrier Cover	17	43180				
4	KIT – Spindle	-	700013				
5	Spindle – Wheel Bearing	61	620061				
6	Nut & Pin Assembly	67	660568				
7	Lockwasher – Wheel Bearing Nut	68	621028				
8	Spindle Nut	69	621027				
9	Spacer	70	—				
10	Gear – Axle Drive	71	—				
11	Hub Cap	73	—				

GM /Chevrolet 1984-1996 1/2

Model 36 /200 ICA Rear Axles for

Corvette

GM Model 36 /200 ICA Rear Axles Exploded View

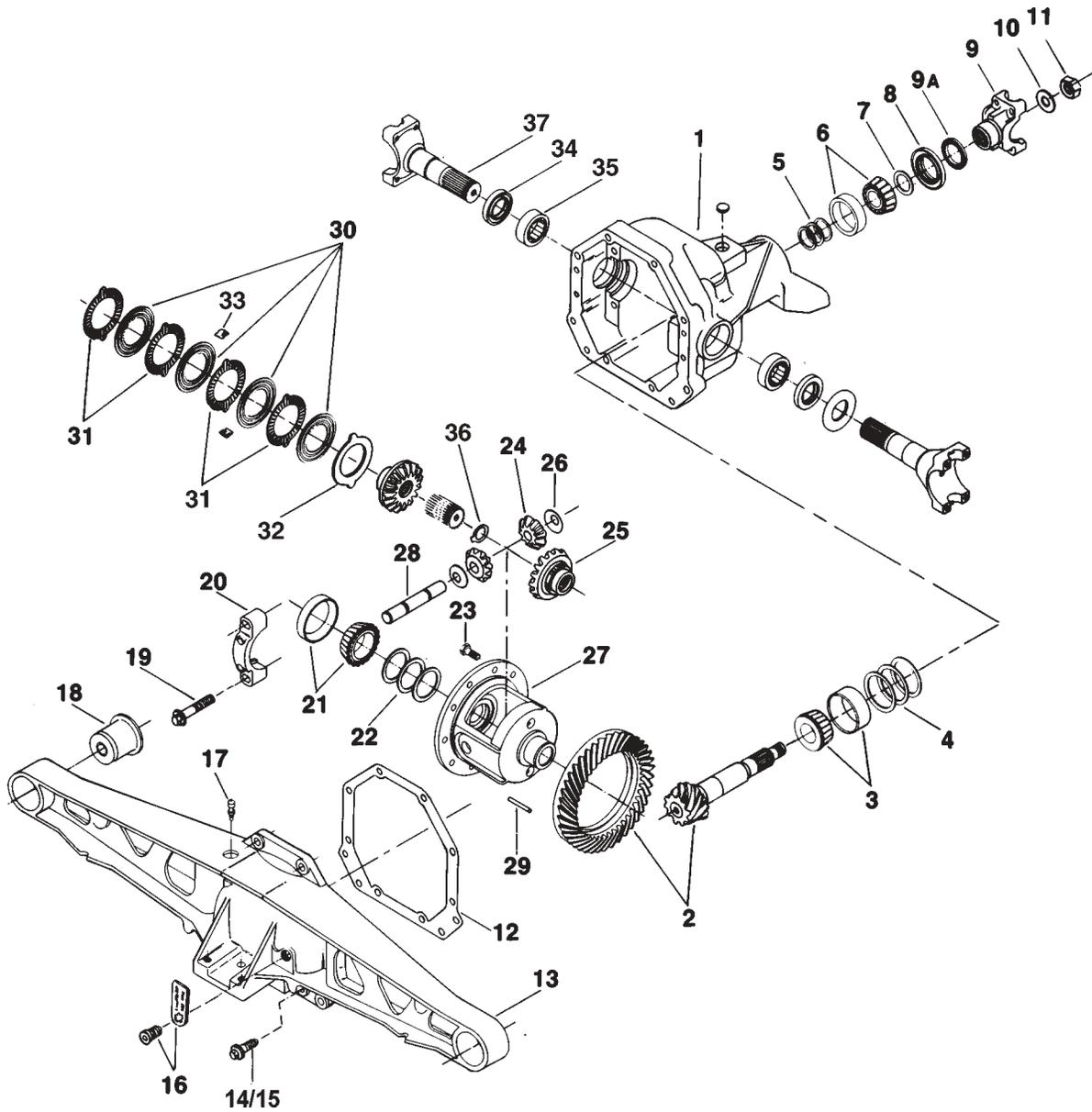

GM Model 36 /200 ICA Rear Axles Parts Listing

ITEM NO.	PART NUMBER	DESCRIPTION	ITEM NO.	PART NUMBER	DESCRIPTION
1	— ⁽³⁾	Housing – Axle Service	21	706016X	KIT – Differential Bearing
2	— ⁽¹⁾	Drive Pinion & Gear Assembly	22	706878X	PKG – Diff Bearing Shim (inc 12, 36)
3	706015X	KIT – Inner Pinion Bearing	23	41221	Bolt – Drive Gear (qty 10)
4	74438X	PKG – Inner Pinion Bearing Shim	24	— ⁽²⁾	Pinion – Differential
5	73173X	PKG – Outer Pinion Bearing Shim	25	— ⁽²⁾	Gear – Differential
6	706014X	KIT – Outer Pinion Bearing	26	40266	Thrustwasher – Diff Pinion
7	41012	Slinger – Outer Pinion Bearing	27	— ⁽³⁾	Case – Differential
8	41455	Seal – Pinion Oil	28	— ⁽²⁾	Shaft – Differential
9	2-4-6641-1	End Yoke	29	13449	Lock – Differential Shaft
9A	42502	Slinger – End Yoke		707386X	KIT – Differential Plate & Disc
10	30186	Washer – Pinion Nut			(inc items 12, 29, 30, 31, 32, 33, 36)
11	30185	Pinion Nut	30	— ⁽⁴⁾	Disc – Differential
12	38615	RTV Silicone Sealant	31	— ⁽⁴⁾	Plate – Differential
13	— ⁽³⁾	Arm – Carrier Cover Support	32	— ⁽⁴⁾	Spacer – Dished
14	40286-1	Screw – Carrier Cover	33	40835	Clip – Differential Clutch Retainer
15	40286-2	Screw – Carrier Cover		706880X	KIT – Unit Bearing & Seal
16	39527	Fill Plug			(inc items 12, 34, 35, 36)
17	40750	Breather Vent	34	40108	Oil Seal
18	— ⁽³⁾	Bushing – Carrier Cover Arm	35	565987	Bearing – Inner Yoke Shaft
19	40284-2	Bolt – Differential Bearing Cap	36	— ⁽⁴⁾	Snap Ring
20	— ⁽³⁾	Differential Bearing Cap	37	— ⁽¹⁾	Shaft – Inner Yoke

(1) See "Bill of Material Table" on next page

(2) See "Variable Parts Table" below

(3) Contact Vehicle Manufacturer

(4) Not Sold Separately

Variable Parts Listing

Kits & Parts - Use With All Applications							
Description & Item Number (Refer to "Exploded View" on the previous page)			Bills of Material				
			605172 605180 605239	605260 605321 605490			
1	Pinion – Differential	24	40265	41599			
2	Gear – Differential	25	40276	44038			
3	Shaft – Differential	28	41028	41519			

GM Model 36 /200 ICA Rear Axles

Bill of Material Table

Axle			Axle Kits				Shaft & Joint Assy.	
Bill of Material	Diff. Type	Ratio	Ring Gear & Pinion Kit ⁽⁷⁾	Differential			Right Hand Shaft Assy.	Left Hand Shaft Assy.
				Case Assy. Kit ⁽⁸⁾	Case Kit	Inner Parts Kit		
1984 Corvette								
605172-1	Trac Lok	3.07	72505-5X	706872X	706874X	706875X	3-82-1001-2	3-82-1001-1
605172-2	Trac Lok	3.31	72504-5X	706872X	706874X	706875X	3-82-1001-2	3-82-1001-1
605180-1	Trac Lok	3.07	72505-5X	706872X	706874X	706875X	3-82-1001-2	3-82-1001-1
605180-2	Trac Lok	3.31	72504-5X	706872X	706874X	706875X	3-82-1001-2	3-82-1001-1
605180-3	Trac Lok	3.07	72505-5X	706872X	706874X	706875X	3-82-1001-2	3-82-1001-1
605180-4	Trac Lok	3.07	72505-5X	706872X	706874X	706875X	3-82-1001-2	3-82-1001-1
605180-5	Trac Lok	3.31	72504-5X	706872X	706874X	706875X	3-82-1001-2	3-82-1001-1
605180-6	Trac Lok	3.07	72505-5X	706872X	706874X	706875X	3-82-1001-2	3-82-1001-1
605180-7	Trac Lok	2.73	72587-5X	706871X	706873X	706875X	3-82-1001-2	3-82-1001-1
1984-86 Corvette								
605239-1	Trac Lok	2.73	72587-5X	706871X	706873X	706875X	3-82-1001-2	3-82-1001-1
605239-2	Trac Lok	3.07	72505-5X	706872X	706874X	706875X	3-82-1001-2	3-82-1001-1
605239-3	Trac Lok	3.31	72504-5X	706872X	706874X	706875X	3-82-1001-2	3-82-1001-1
605239-4	Trac Lok	3.07	72505-5X	706872X	706874X	706875X	3-82-1001-2	3-82-1001-1
1985-87 Corvette								
605260-1	Trac Lok	2.73	72587-5X	74224X ⁽⁹⁾	707015X	707226X	41533-1	41533-2
605260-2	Trac Lok	3.07	72505-5X	74230X ⁽⁹⁾	707016X	707226X	41533-1	41533-2
605260-3	Trac Lok	3.31	72504-5X	74230X ⁽⁹⁾	707016X	707226X	41533-1	41533-2
605260-4	Trac Lok	3.07	72505-5X	74230X ⁽⁹⁾	707016X	707226X	41533-1	41533-2
605260-5	Trac Lok	2.53	72839-5X	74224X ⁽⁹⁾	707015X	707226X	41533-1	41533-2
605260-6	Trac Lok	2.59	72668-5X	74224X ⁽⁹⁾	707015X	707226X	41533-1	41533-2
1988-90 Corvette								
605321-1	Trac Lok	2.73	72587-5X	74224X ⁽⁹⁾	707015X	707226X	41533-1	41533-2
605321-4	Trac Lok	3.07	72505-5X	74230X ⁽⁹⁾	707016X	707226X	41533-1	41533-2
605321-6	Trac Lok	2.59	72668-5X	74224X ⁽⁹⁾	707015X	707226X	41533-1	41533-2
1990 1/2-96 1/2 Corvette								
605490-1	Trac Lok	2.73	72587-5X	74224X ⁽⁹⁾	707015X	707226X	41533-1	41533-2
605490-2	Trac Lok	3.07	72505-5X	74230X ⁽⁹⁾	707016X	707226X	41533-1	41533-2
605490-4	Trac Lok	2.59	72668-5X	74224X ⁽⁹⁾	707015X	707226X	41533-1	41533-2

(7) See Ring Gear & Pinion Kits in XGI Catalog for ratio & tooth combinations.
(8) See Differential Case Assy Kits in XGI Catalog for spline data & ratios.
(9) This is a case assembly and does not include shims, bearings or drive gear screws.

GM / Chevrolet 1980 - 1996 1/2

Model 44 /216 ICA Rear Axles for

Corvette

GM / Chevrolet 44 /216 ICA Rear Axles Exploded View

X510-9

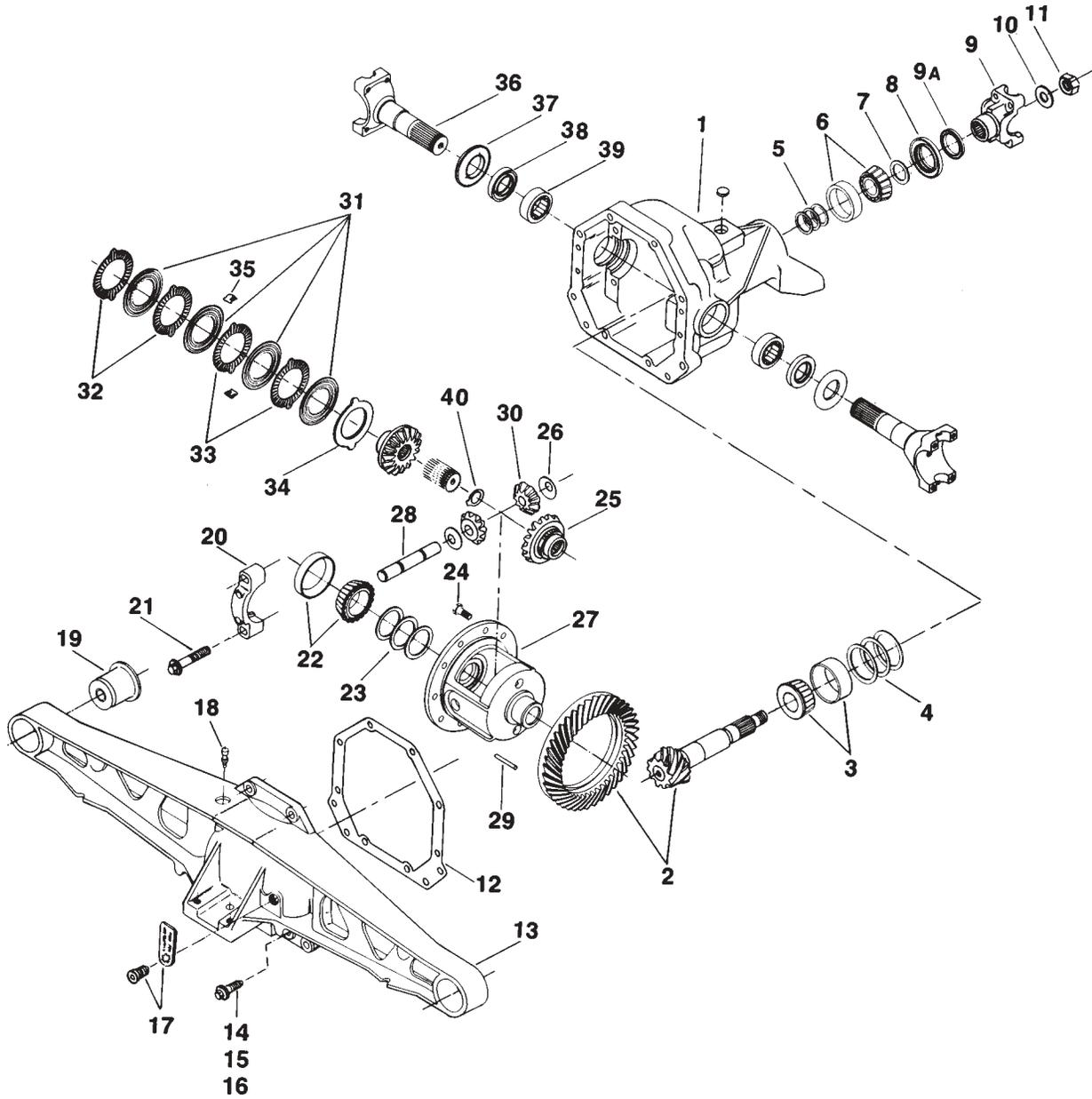

GM / Chevrolet 44 /216 ICA Rear Axles

Parts Listing

ITEM NO.	PART NUMBER	DESCRIPTION	ITEM NO.	PART NUMBER	DESCRIPTION
1	— ⁽³⁾	Housing – Axle Service	22	— ⁽²⁾	KIT – Differential Bearing
2	— ⁽¹⁾	Drive Pinion & Gear Assembly	23	706757X	PKG – Diff & Pinion Bearing Shim
3	— ⁽²⁾	KIT – Inner Pinion Bearing	24	— ⁽²⁾	Bolt – Drive Gear (qty 10)
4	72922-1X	PKG – Inner Pinion Bearing Shims	25	—	Gear – Differential
5	72921X	PKG – Outer Pinion Bearing Shims	26	13338-3	Thrustwasher – Differential Pinion
6	— ⁽²⁾	KIT – Outer Pinion Bearing	27	— ⁽¹⁾	Case – Differential
7	42737	Thrustwasher – Bearing	28	— ⁽²⁾	Shaft – Differential
8	— ⁽²⁾	Seal – Pinion Oil	29	13449	Lock – Differential Shaft
9	— ⁽²⁾	End Yoke or Assembly (inc 9A)	30	— ⁽²⁾	Pinion – Differential
9A	— ⁽²⁾	Slinger – End Yoke		707018X	KIT – Differential Plate & Disc
10	30275	Washer – Pinion Nut			(inc items 31, 32, 33, 34, 35)
11	30271	Pinion Nut	31	— ⁽⁴⁾	Disc – Differential
12	38615	RTV Silicone Sealant	32	— ⁽⁴⁾	Plate – Differential
13	— ⁽³⁾	Arm – Carrier Cover Support	33	— ⁽⁴⁾	Plate – Differential
14	40326-2	Screw – Carrier Cover (qty 5)	34	— ⁽⁴⁾	Spacer – Dished
15	43507	Nut – Carrier Cover (qty 2)	35	40835	Clip – Differential Clutch Retainer
16	44539	Bolt – Carrier Cover (qty 2)	36	— ⁽¹⁾	Shaft – Inner Yoke
17	39527	Fill Plug	37	41218	Shield – Stone
18	40750	Breather Vent	38	— ⁽²⁾	Oil Seal
19	—	Bushing – Carrier Cover	39	566002	Bearing – Inner Yoke Shaft
20	— ⁽³⁾	Differential Bearing Cap	40	— ⁽⁴⁾	Snap Ring
21	41212	Bolt – Differential Bearing Cap			

(1) See "Bill of Material Table" on next page

(2) See "Variable Parts Table" below

(3) Contact Vehicle Manufacturer

(4) Not Sold Separately

Variable Parts Listing

Kits & Parts - Use With All Applications							
Description & Item Number (Refer to "Exploded View" on the previous page)			Bills of Material				
			603967	605062	605220 605322 605417	605491 605492	
1	KIT – Inner Pinion Bearing	3	706015X	706015X	706996X	706996X	
2	KIT – Outer Pinion Bearing	6	706014X	706014X	706123X	706123X	
3	Seal – Pinion Oil	8	39118	39118	42449	42449	
4	End Yoke or Assembly (inc 9A)	9	2-4-8091-1X	2-4-8091-1X	2-4-6541-1	2-4-6541-1	
5	Slinger – End Yoke	9A	15099	15099	42501	42501	
6	KIT – Differential Bearing	22	706110X	706110X	706988X	706988X	
7	Bolt – Drive Gear (qty 10)	24	40164	40164	41221	41221	
8	Shaft – Differential	28	35659	35659	41219	41219	
9	Pinion – Differential	30	32808	32808	32808	44010	
10	Oil Seal	38	39590	41220	41220	41220	

GM / Chevrolet 44 /216 ICA Rear Axles

Bill of Material Table

Axle			Axle Kits				Shaft & Joint Assy.	
Bill of Material	Diff. Type	Ratio	Ring Gear & Pinion Kit ⁽⁷⁾	Differential			Right Hand Shaft Assy.	Left Hand Shaft Assy.
				Case Assy. Kit ⁽⁸⁾	Case Kit	Inner Parts Kit		
1980 Corvette								
603967-1	Trac Lok	3.54	706755-2X	706752X	706753X	706754X	70987-2X	70987-1X
603967-2	Trac Lok	3.31	706755-1X	706752X	706753X	706754X	71090-2X	71090-1X
603967-3	Trac Lok	3.73	706755-3X	706752X	706753X	706754X	70987-2X	70987-1X
603967-4	Trac Lok	2.72	706755-8X	706752X	706753X	706754X	71090-2X	71090-1X
603967-5	Trac Lok	3.31	706755-1X	706752X	706753X	706754X	71090-2X	71090-1X
603967-6	Trac Lok	3.07	706755-4X	706752X	706753X	706754X	71090-2X	71090-1X
603967-7	Trac Lok	3.07	706755-4X	706752X	706753X	706754X	71090-2X	71090-1X
603967-8	Trac Lok	3.54	706755-2X	706752X	706753X	706754X	70987-2X	70987-1X
603967-9	Trac Lok	3.23	706755-6X	706752X	706753X	706754X	70987-2X	70987-1X
603967-10	Trac Lok	3.23	706755-6X	706752X	706753X	706754X	70987-2X	70987-1X
603967-11	Trac Lok	2.72	706755-8X	706752X	706753X	706754X	71090-2X	71090-1X
603967-12	Trac Lok	3.73	706755-3X	706752X	706753X	706754X	70987-2X	70987-1X
603967-13	Trac Lok	2.87	706755-9X	706752X	706753X	706754X	71090-2X	71090-1X
603967-14	Trac Lok	2.87	706755-9X	706752X	706753X	706754X	71090-2X	71090-1X
1981-83 Corvette								
605062-1	Trac Lok	2.72	706755-8X	706752X	706753X	706754X	71090-2X	71090-1X
605062-2	Trac Lok	2.87	706755-9X	706752X	706753X	706754X	70987-2X	70987-1X
605062-3	Trac Lok	2.72	706755-8X	706752X	706753X	706754X	70987-2X	70987-1X
605062-4	Trac Lok	2.72	706755-8X	706752X	706753X	706754X	70987-2X	70987-1X
605062-5	Trac Lok	2.72	706755-8X	706752X	706753X	706754X	71090-2X	71090-1X
605062-6	Trac Lok	2.87	706755-9X	706752X	706753X	706754X	71090-2X	71090-1X
605062-7	Trac Lok	2.87	706755-9X	706752X	706753X	706754X	71090-2X	71090-1X
605062-8	Trac Lok	3.07	706755-4X	706752X	706753X	706754X	70987-2X	70987-1X
1985-87 Corvette								
605220-1	Trac Lok	2.72	72622-5X ⁽⁹⁾	72400X ⁽¹⁰⁾	41210 ⁽¹¹⁾	707225X	72404-1X	72404-2X
605220-2	Trac Lok	3.07	72719-5X ⁽⁹⁾	74229X ⁽¹⁰⁾	41232 ⁽¹¹⁾	707225X	72404-1X	72404-2X
605220-3	Trac Lok	3.31	72602-5X ⁽⁹⁾	74229X ⁽¹⁰⁾	41232 ⁽¹¹⁾	707225X	72404-1X	72404-2X
605220-6	Trac Lok	2.87	72686-5X ⁽⁹⁾	72400X ⁽¹⁰⁾	41210 ⁽¹¹⁾	707225X	72404-1X	72404-2X
605220-7	Trac Lok	3.07	72719-5X ⁽⁹⁾	74229X ⁽¹⁰⁾	41232 ⁽¹¹⁾	707225X	72404-1X	72404-2X
1989 1/2-90 Corvette								
605322-5	Trac Lok	3.33	73919-5X ⁽⁹⁾	74229X ⁽¹⁰⁾	41232 ⁽¹¹⁾	707225X	72404-1X	72404-2X
605322-7	Trac Lok	3.54	73134-5X ⁽⁹⁾	74229X ⁽¹⁰⁾	41232 ⁽¹¹⁾	707225X	72404-1X	72404-2X
605322-9	Trac Lok	3.45	75518-5X ⁽⁹⁾	74229X ⁽¹⁰⁾	41232 ⁽¹¹⁾	707225X	72404-1X	72404-2X
1990-90 1/2 Corvette								
605417-4	Trac Lok	3.54	73134-5X ⁽⁹⁾	72405X ⁽¹⁰⁾	41232 ⁽¹¹⁾	707225X	72404-1X	72404-2X
1990-96 1/2 Corvette								
605491-2	Trac Lok	3.33	73919-5X ⁽⁹⁾	74229X ⁽¹⁰⁾	41232 ⁽¹¹⁾	707225X	72404-1X	72404-2X
605491-3	Trac Lok	3.45	75518-5X ⁽⁹⁾	74229X ⁽¹⁰⁾	41232 ⁽¹¹⁾	707225X	72404-1X	72404-2X
605491-4	Trac Lok	3.54	73134-5X ⁽⁹⁾	74229X ⁽¹⁰⁾	41232 ⁽¹¹⁾	707225X	72404-1X	72404-2X
605491-6	Trac Lok	3.33	73919-5X ⁽⁹⁾	74229X ⁽¹⁰⁾	41232 ⁽¹¹⁾	707225X	72404-1X	72404-2X
1990 1/2 Corvette								
605492-1	Trac Lok	3.54	73134-5X ⁽⁹⁾	74229X ⁽¹⁰⁾	41232 ⁽¹¹⁾	707225X	72404-1X	72404-2X

(7) See Ring Gear & Pinion Kits in XGI Catalog for ratio & tooth combinations.
(8) See Differential Case Assy Kits in XGI Catalog for spline data & ratios.
(9) This kit includes ring gear, pinion, nut, washer and drive gear screws.
(10) This case assembly does not include shims, bearings or drive gear screws.
(11) This is a bare case.

GM / Chevrolet 1984 - 1994

Model 44 /216 Rear Axles for

F-Car

GM / Chevrolet 44 /216 Rear Axles for F-Car Exploded View

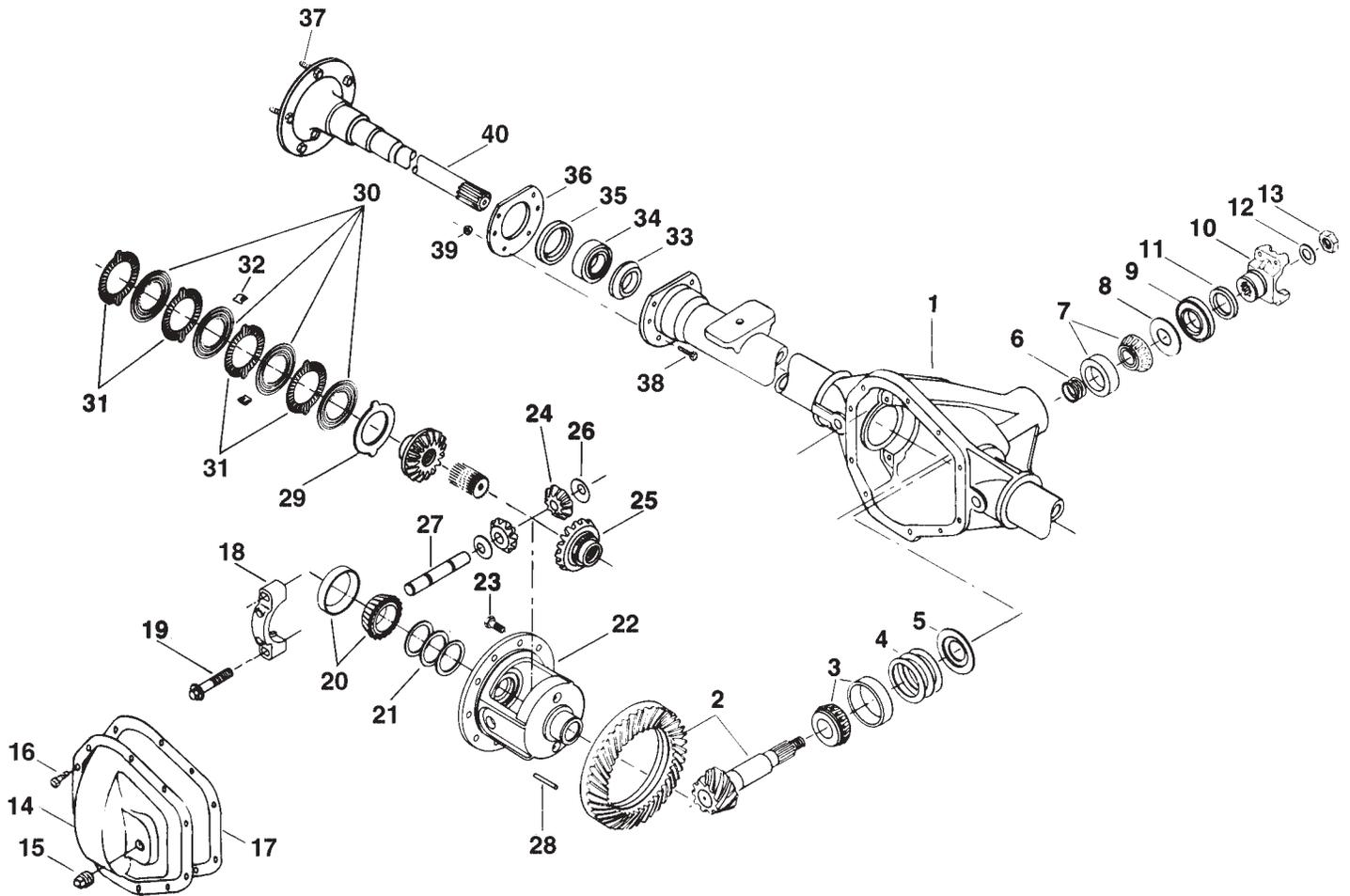

GM / Chevrolet 44 /216 Rear Axles for F-Car Parts Listing

ITEM NO.	PART NUMBER	DESCRIPTION	ITEM NO.	PART NUMBER	DESCRIPTION
1	— ⁽³⁾	Housing – Axle Service	19	48632-1	Bolt – Differential Bearing Cap
2	— ⁽¹⁾	Drive Pinion & Gear Assembly	20	706032X	KIT – Differential Bearing
3	706031X	KIT – Inner Pinion Bearing	21	701005X	PKG – Diff & Pinion Bearing Shim
4	—	Inner Pinion Bearing Shims (see shim packages)	22	— ⁽⁴⁾	Case – Differential (t/l)
5	—	Baffle – Pinion Bearing	23	41221	Bolt – Drive Gear (qty 10)
6	—	Outer Pinion Bearing Shims (see shim packages)	24	41193	Pinion – Differential (t/l)
	701067X	PKG – Diff & Pinion Bearing Shim (inc items 4, 6, 21)	25	46618	Gear – Differential (t/l)
	701066X	PKG – Pinion Bearing Shim (inc items 4, 6)	26	13338-3	Thrustwasher – Diff Pinion (t/l)
7	706030X	KIT – Outer Pinion Bearing	27	39194	Shaft – Differential
8	41012	Slinger – Outer Pinion Bearing	28	13449	Lock – Differential Shaft
9	— ⁽²⁾	Seal – Pinion Oil		706352X	KIT – Differential Plate & Disc (t/l) (inc items 29, 30, 31, 32)
10	— ⁽²⁾	End Yoke Assembly (inc 11)	29	— ⁽⁴⁾	Plate – Differential Dished
11	41498	Slinger – End Yoke	30	— ⁽⁴⁾	Disc – Differential
12	30186	Washer – Pinion Nut	31	— ⁽⁴⁾	Plate – Differential
13	30185	Pinion Nut	32	40835	Clip – Differential Clutch Retainer
	707109X	KIT – Carrier Cover (inc items 14, 15, 16)		706989X	KIT – Unit Bearing and Seal (inc items 33, 34, 35, 36)
14	42960-2	Carrier Cover	33	36121	Retainer Ring – Wheel Bearing
15	43180	Plug – Carrier Cover	34	565909	Wheel Bearing Assembly
16	34279	Bolt – Carrier Cover	35	35938	Seal – Outboard Shaft
17	38615	RTV Silicone Sealant	36	41181	Oil Seal Retainer
18	— ⁽³⁾	Differential Bearing Cap	37	40544	Wheel Bolt
			38	— ⁽³⁾	Bolt – Brake Mounting
			39	— ⁽³⁾	Nut – Brake Mounting
			40	— ⁽¹⁾	Shaft – Axle Flange Drive

(1) See "Bill of Material Table" on next page

(2) See "Variable Parts Table" below

(3) Contact Vehicle Manufacturer

(4) Not Sold Separately

Variable Parts Listing

Kits & Parts - Use With All Applications							
Description & Item Number (Refer to "Exploded View" at the front of this section)			Bills of Material				
			605218	605558			
1	Seal – Pinion Oil	9	39118	41455			
2	End Yoke Assembly (inc 11)	10	2-4-3581-1X ⁽¹⁰⁾	2-4-8091X			

(10) Bearing strap kit used with end yoke.

GM / Chevrolet 44 /216 Rear Axles for F-Car

Bill of Material Table

Axle			Axle Kits				Shaft & Joint Assy.	
Bill of Material	Diff. Type	Ratio	Ring Gear & Pinion Kit ⁽⁷⁾	Differential			Right Hand Shaft Assy.	Left Hand Shaft Assy.
				Case Assy. Kit ⁽⁸⁾	Case Kit	Inner Parts Kit		
1984-85 F-Car								
605218-1	Trac Lok	3.31	706990-1X	707132X	707133X	707134X	72384-2X	72384-1X
605218-2	Trac Lok	4.09	706990-2X	707155X	707156X	707134X	72384-2X	72384-1X
605218-3	Trac Lok	3.92	706990-3X	707155X	707156X	707134X	72384-2X	72384-1X
1992 1/2-94 F-Car								
605558-1	Trac Lok	3.54	72950-5X ⁽⁹⁾	707132X	707133X	707134X	74555-1X	74555-2X

- (7) See Ring Gear & Pinion Kits in XGI Catalog for ratio & tooth combinations.
- (8) See Differential Case Assy Kits in XGI Catalog for spline data & ratios.
- (9) Kit includes ring gear, pinion, washer, nut and drive gear screws.

GM / Chevrolet 1979-1991 1/2

Model 60 /248 Rear Axles for

G-Van

GM Model 60 /248 Rear Axles Exploded View

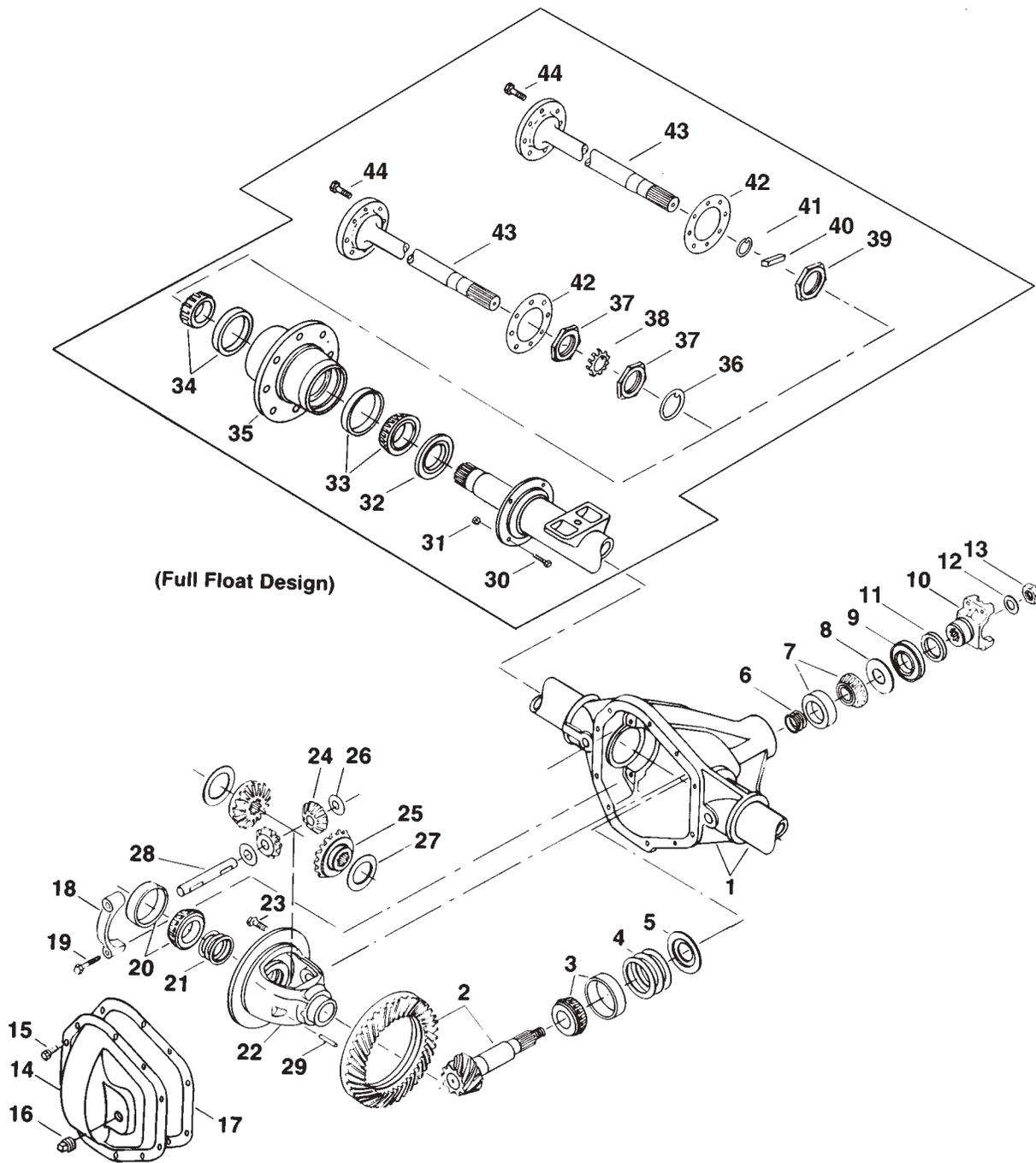

GM Model 60 /248 Rear Axles Parts Listing



ITEM NO.	PART NUMBER	DESCRIPTION	ITEM NO.	PART NUMBER	DESCRIPTION
1	— ⁽³⁾	Housing – Axle Service	19	48632-1	Bolt – Differential Bearing Cap
2	— ⁽¹⁾	Drive Pinion & Gear Assembly	20	706047X	KIT – Differential Bearing
3	706046X	KIT – Inner Pinion Bearing	21	706378X	PKG – Diff Bearing Shim (inc 17)
	706375X	PKG – Diff & Pinion Bearing Shim (inc items 4, 6, 12, 13, 17, 21)	22	— ⁽⁴⁾	Case – Differential (std)
	706359X	PKG – Pinion Bearing Shim (inc items 4, 6, 12, 13, 17)	23	40638	Bolt – Drive Gear (qty 12)
4	—	Inner Pinion Bearing Shims (see shim packages)	24	34367	Pinion – Differential (std)
5	30982	Baffle – Pinion Bearing	25	35625	Gear – Differential (std)
6	—	Outer Pinion Bearing Shims (see shim packages)	26	34730	Thrustwasher – Diff Pinion (std)
7	706045X	KIT – Outer Pinion Bearing	27	34729	Thrustwasher – Diff Gear (std)
8	42737	Thrustwasher	28	30263	Shaft – Differential (std)
9	42449	Seal – Pinion Oil	29	44810	Lock – Differential Shaft
10	3-4-5731-1X	End Yoke Assembly (inc 11) Bearing strap kit used w/end yoke	30	— ⁽³⁾	Bolt – Brake Mounting
11	232752	Slinger – End Yoke	31	— ⁽³⁾	Nut – Brake Mounting
12	30275	Washer – Pinion Nut	32	— ⁽³⁾	Hub Seal
13	30271	Pinion Nut	33	706179X	KIT – Inner Wheel Bearing
	— ⁽²⁾	KIT – Carrier Cover (inc items 14, 15, 16)	34	706074X	KIT – Outer Wheel Bearing
14	— ⁽²⁾	Carrier Cover	35	— ⁽³⁾	Wheel Hub
15	34822	Bolt – Carrier Cover	36	— ⁽²⁾	Thrustwasher – Wheel Bearing
16	— ⁽²⁾	Plug – Carrier Cover	37	— ⁽²⁾	Spindle Nut
17	34687	Gasket	38	— ⁽²⁾	Lockwasher – Wheel Bearing
18	— ⁽³⁾	Differential Bearing Cap	39	— ⁽³⁾	Spindle Nut
			40	— ⁽³⁾	Key – Square
			41	— ⁽³⁾	Snap Ring
			42	36554	Gasket
			43	— ⁽¹⁾	Axle Shaft
			44	37871	Bolt – Axle Shaft

- (1) See "Bill of Material Table" on next page
- (2) See "Variable Parts Table" below
- (3) Contact Vehicle Manufacturer
- (4) Not Sold Separately

Variable Parts Listing

Kits & Parts - Use With All Applications						
Description & Item Number (Refer to "Exploded View" on previous page)			Bills of Material			
			603702 603884	605000 605001	605132 605133 605200	605201 605268 605403 605405 605495 605496
1	KIT – Carrier Cover	-	706128X	707108X	707233X	707108X
2	Carrier Cover	14	34675	42799-2	43600-1	42799-2
3	Plug – Carrier Cover	16	36472	43180	43180	43180
4	Thrustwasher – Wheel Bearing	36	33734	—	—	—
5	Spindle Nut	37	33732	—	—	—
6	Lockwasher – Wheel Bearing	38	33733	—	—	—

GM Model 60 /248 Rear Axles

Bill of Material Table

Axle			Axle Kits				Shaft & Joint Assy.	
Bill of Material	Diff. Type	Ratio	Ring Gear & Pinion Kit ⁽⁷⁾	Differential			Right Hand Shaft Assy.	Left Hand Shaft Assy.
				Case Assy. Kit ⁽⁸⁾	Case Kit	Inner Parts Kit		
1979 DRW G-Van 125" WB - Full Float								
603884-1	Standard	4.56	706033-4X	706182X	706041X	706702X	41100-1	41100-1
603884-2	Standard	4.10	706033-3X	706180X	706040X	706702X	41100-1	41100-1
1979 DRW G-Van 146" WB - Full Float								
603702-1	Standard	4.56	706033-4X	706182X	706041X	706702X	41100-1	41100-1
603702-2	Standard	4.10	706033-3X	706180X	706040X	706702X	41100-1	41100-1
1980-82 DRW G-Van 125" WB - Full Float								
605000-1	Standard	4.56	706033-4X	706182X	706041X	706702X	41100-1	41100-1
605000-2	Standard	4.10	706033-3X	706180X	706040X	706702X	41100-1	41100-1
605000-3	Standard	4.10	706033-3X	706180X	706040X	706702X	41100-1	41100-1
605000-4	Standard	4.56	706033-4X	706182X	706041X	706702X	41100-1	41100-1
605000-5	Standard	4.10	706033-3X	706180X	706040X	706702X	41100-1	41100-1
605000-6	Standard	4.56	706033-4X	706182X	706041X	706702X	41100-1	41100-1
1980-82 DRW G-Van 146" WB - Full Float								
605001-1	Standard	4.56	706033-4X	706182X	706041X	706702X	41100-1	41100-1
605001-2	Standard	4.10	706033-3X	706180X	706040X	706702X	41100-1	41100-1
605001-3	Standard	4.10	706033-3X	706180X	706040X	706702X	41100-1	41100-1
605001-4	Standard	4.56	706033-4X	706182X	706041X	706702X	41100-1	41100-1
605001-5	Standard	4.10	706033-3X	706180X	706040X	706702X	41100-1	41100-1
605001-6	Standard	4.56	706033-4X	706182X	706041X	706702X	41100-1	41100-1
1983 DRW G-Van 125" WB - Full Float								
605132-1	Standard	4.56	706033-4X	706182X	706041X	706702X	41100-1	41100-1
605132-2	Standard	4.10	706033-3X	706180X	706040X	706702X	41100-1	41100-1
1983 DRW G-Van 146" WB - Full Float								
605133-1	Standard	4.56	706033-4X	706182X	706041X	706702X	41100-1	41100-1
605133-2	Standard	4.10	706033-3X	706180X	706040X	706702X	41100-1	41100-1
1985-86 DRW G-Van 125" WB - Full Float								
605200-1	Standard	4.10	706033-3X	706180X	706040X	706702X	41100-1	41100-1
605200-2	Standard	4.56	706033-3X	706180X	706040X	706702X	41100-1	41100-1
1985-89 DRW G-Van 146" WB - Full Float								
605201-1	Standard	4.10	706033-3X	706180X	706040X	706702X	41100-1	41100-1
605201-2	Standard	4.56	706033-4X	706182X	706041X	706702X	41100-1	41100-1
1986-89 DRW G-Van 125" WB - Full Float								
605268-1	Standard	4.10	706033-3X	706180X	706040X	706702X	41100-1	41100-1
605268-2	Standard	4.56	706033-4X	706182X	706041X	706702X	41100-1	41100-1
1990 DRW G-Van 125" WB - Full Float								
605405-1	Standard	4.10	706033-3X	706180X	706040X	706702X	41100-1	41100-1
605405-2	Standard	4.56	706033-4X	706182X	706041X	706702X	41100-1	41100-1
1990 DRW G-Van 146" WB - Full Float								
605403-1	Standard	4.10	706033-3X	706180X	706040X	706702X	41100-1	41100-1
605403-2	Standard	4.56	706033-4X	706182X	706041X	706702X	41100-1	41100-1
1990 1/2-91 1/2 DRW G-Van 125" WB - Full Float								
605496-1	Standard	4.10	706033-3X	706180X	706040X	706702X	41100-1	41100-1
605496-2	Standard	4.56	706033-4X	706182X	706041X	706702X	41100-1	41100-1
1990 1/2-91 1/2 DRW G-Van 146" WB - Full Float								
605495-1	Standard	4.10	706033-3X	706180X	706040X	706702X	41100-1	41100-1
605495-2	Standard	4.56	706033-4X	706182X	706041X	706702X	41100-1	41100-1

(7) See Ring Gear & Pinion Kits in XGI Catalog for ratio & tooth combinations.

(8) See Differential Case Assy Kits in XGI Catalog for spline data & ratios.

GM / Chevrolet 1979-1994

Model 70 /267 Rear Axles for

C-30

DRW G-Van, SRW G-Van

G-Van Extended

G-300

K-30

P-30, P-300

R-30

V-30

GM Model 70 /267 Rear Axles Exploded View

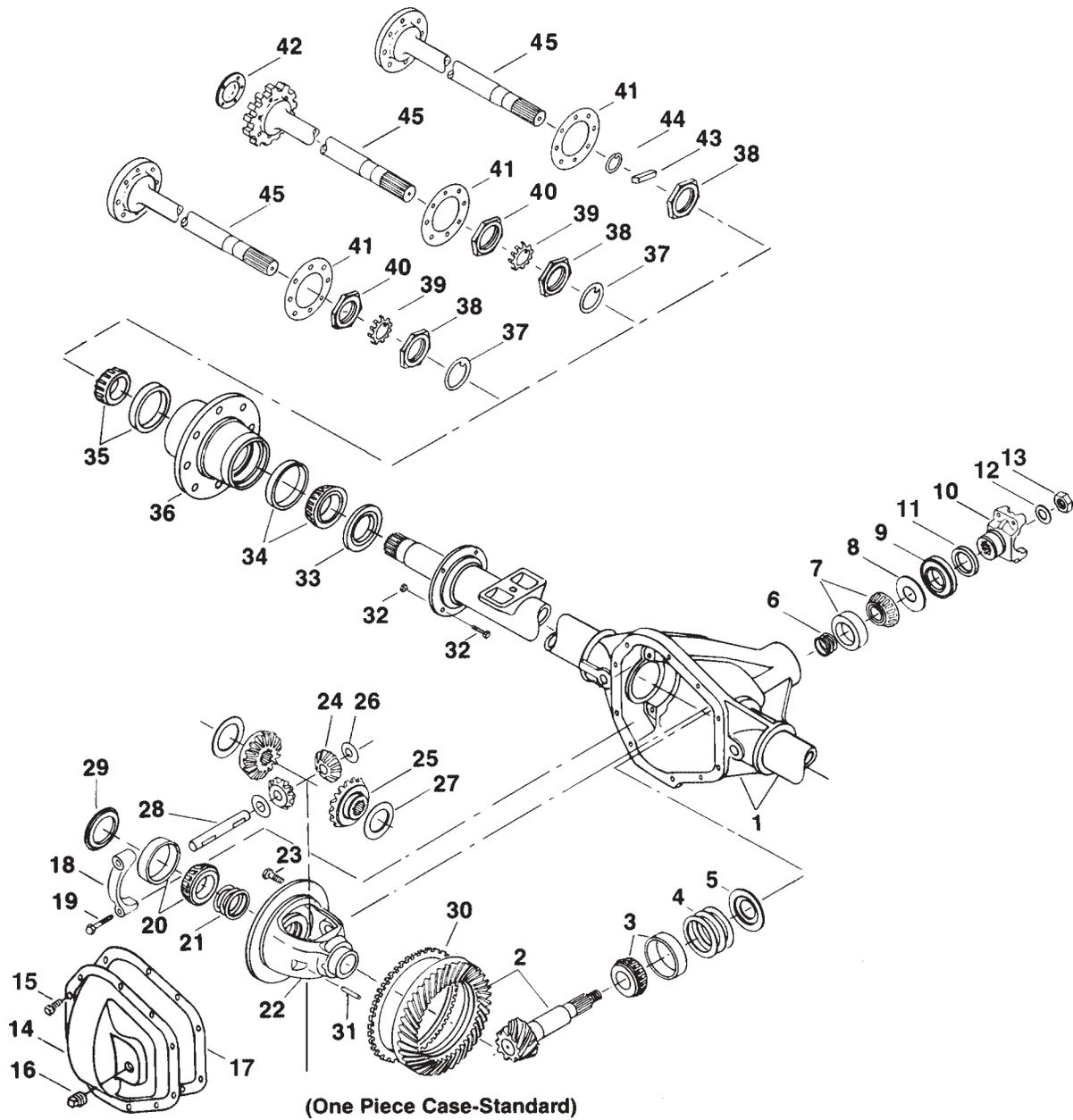

GM Model 70 /267 Rear Axles

Parts Listing

ITEM NO.	PART NUMBER	DESCRIPTION	ITEM NO.	PART NUMBER	DESCRIPTION
1	— ⁽³⁾	Housing – Axle Service	20	— ⁽²⁾	KIT – Differential Bearing
2	— ⁽¹⁾	Drive Pinion & Gear Assembly	21	— ⁽²⁾	PKG – Diff Bearing Shim (inc 17)
3	— ⁽²⁾	KIT – Inner Pinion Bearing	22	— ⁽⁴⁾	Case – Differential (std)
4	—	Inner Pinion Bearing Shims (see shim packages)	23	— ⁽²⁾	Bolt – Drive Gear (qty 12)
	706357X	PKG – Pinion Bearing Shim (inc items 4, 6, 12, 13, 17)	24	35080	Pinion – Differential (std)
5	— ⁽²⁾	Baffle – Pinion Bearing	25	35079	Gear – Differential (std)
6	—	Outer Pinion Bearing Shims (see shim packages)	26	35082	Thrustwasher – Diff Pinion (std)
	— ⁽²⁾	PKG – Diff & Pinion Bearing Shim (inc items 4, 6, 12, 13, 17, 21)	27	34729	Thrustwasher – Diff Gear (std)
7	706045X	KIT – Outer Pinion Bearing	28	— ⁽²⁾	Shaft – Differential (std)
8	42737	Thrustwasher – Bearing	29	— ⁽²⁾	Spacer – Differential Bearing
9	42449	Seal – Pinion Oil	30	—	Tone Ring (ABS)
10	— ⁽²⁾	End Yoke Assembly (inc 11)	31	47024	Lock – Differential Shaft (std)
11	232752	Slinger – End Yoke	32	— ⁽³⁾	Nut/Bolt – Brake Mounting
12	30275	Washer – Pinion Nut	33	39693	Hub Seal
13	30271	Pinion Nut	34	— ⁽²⁾	KIT – Inner Wheel Bearing
	— ⁽²⁾	KIT – Carrier Cover (inc items 14, 15, 16)	35	— ⁽²⁾	KIT – Outer Wheel Bearing
14	— ⁽²⁾	Carrier Cover	36	— ⁽³⁾	Wheel Hub
15	34822	Bolt – Carrier Cover (qty 10)	37	— ⁽²⁾	Thrustwasher – Wheel Bearing
16	— ⁽²⁾	Plug – Carrier Cover	38	— ⁽²⁾	Spindle Nut
17	34687	Gasket – Carrier Cover	39	— ⁽²⁾	Lockwasher – Spindle Nut
18	— ⁽³⁾	Differential Bearing Cap	40	— ⁽²⁾	Spindle Nut
19	48632-1	Bolt – Differential Bearing Cap	41	— ⁽²⁾	Gasket
			42	— ⁽²⁾	Hub Cap
			43	— ⁽²⁾	Key – Square
			44	— ⁽²⁾	Snap Ring
			45	— ⁽¹⁾	Axle Shaft

- (1) See "Bill of Material Table" on next page
(2) See "Variable Parts Table" within this section
(3) Contact Vehicle Manufacturer
(4) Not Sold Separately

GM Model 70 /267 Rear Axles

Bill of Material Table

Axle			Axle Kits				Shaft & Joint Assy.	
Bill of Material	Diff. Type	Ratio	Ring Gear & Pinion Kit ⁽⁷⁾	Differential			Right Hand Shaft Assy.	Left Hand Shaft Assy.
				Case Assy. Kit ⁽⁸⁾	Case Kit	Inner Parts Kit		
1979 G-300 146" WB - 70B								
603703-1	Standard	4.10	706999-4X	706051X	706055X	706058X	41100-1	41100-1
603703-2	Standard	4.56	706999-6X	706052X	706056X	706058X	41100-1	41100-1
1979 C-30 Dual Wheel - 70HD								
603704-1	Standard	4.10	706999-4X	706064X	706068X	706058X	41100-1	41100-1
603704-2	Standard	4.56	706999-6X	706065X	706069X	706058X	41100-1	41100-1
603704-3	Standard	3.73	706999-2X	706064X	706068X	706058X	41100-1	41100-1
603704-4	Standard	4.56	706999-6X	706065X	706069X	706058X	41100-1	41100-1
603704-5	Standard	4.10	706999-4X	706064X	706068X	706058X	41100-1	41100-1
603704-6	No Spin	4.10	706999-4X	70716X	706185X	35683	41100-1	41100-1
1979 P-300 Motor Home - 70HD								
603929-1	Standard	4.56	706999-6X	706065X	706069X	706058X	36625-1	36625-1
603929-2	Standard	4.88	706999-8X	706065X	706069X	706058X	36625-1	36625-1
1979 P-300 UPS - 70HD								
603970-1	Standard	4.10	706999-4X	706064X	706068X	706058X	41100-1	41100-1
603987-1	Standard	4.10	706999-4X	706064X	706068X	706058X	41100-1	41100-1
1980-81 C-30 Dual Wheel - 70HD								
605003-1	Standard	4.10	706999-4X	706064X	706068X	706058X	41100-1	41100-1
605003-2	Standard	4.56	706999-6X	706065X	706069X	706058X	41100-1	41100-1
605003-3	Standard	3.73	706999-2X	706064X	706068X	706058X	41100-1	41100-1
605003-4	Standard	3.73	706999-2X	706064X	706068X	706058X	41100-1	41100-1
605003-5	Standard	4.10	706999-4X	706064X	706068X	706058X	41100-1	41100-1
605003-6	Standard	4.56	706999-6X	706065X	706069X	706058X	41100-1	41100-1
605003-7	Standard	4.10	706999-4X	706064X	706068X	706058X	41100-1	41100-1
605003-8	Standard	4.56	706999-6X	706065X	706069X	706058X	41100-1	41100-1
605003-9	Standard	3.73	706999-2X	706064X	706068X	706058X	41100-1	41100-1
605003-10	Standard	3.73	706999-2X	706064X	706068X	706058X	41100-1	41100-1
605003-11	Standard	4.10	706999-4X	706064X	706068X	706058X	41100-1	41100-1
605003-12	Standard	4.10	706999-6X	706065X	706069X	706058X	41100-1	41100-1
1980-81 P-300 Motor Home - 70HD								
605004-1	Standard	4.56	706999-6X	706065X	706069X	706058X	36625-1	36625-1
605004-2	Standard	4.88	706999-8X	706065X	706069X	706058X	36625-1	36625-1
605004-3	Standard	4.56	706999-6X	706065X	706069X	706058X	36625-1	36625-1
605004-4	Standard	4.88	706999-8X	706065X	706069X	706058X	36625-1	36625-1
1980-81 P-300 UPS - 70HD								
605005-1	Standard	4.10	706999-4X	706064X	706068X	706058X	41100-1	41100-1
605005-2	Standard	3.73	706999-2X	706064X	706068X	706058X	41100-1	41100-1
605005-3	Standard	3.73	706999-2X	706064X	706068X	706058X	41100-1	41100-1
605005-4	Standard	4.10	706999-4X	706064X	706068X	706058X	41100-1	41100-1
605005-5	Standard	3.73	706999-2X	706064X	706068X	706058X	41100-1	41100-1
605005-6	Standard	3.73	706999-2X	706064X	706068X	706058X	41100-1	41100-1
1980-81 P-300 Motor Home - 70HD								
605068-1	Standard	4.56	706999-6X	706065X	706069X	706058X	36625-1	36625-1
605068-2	Standard	4.88	706999-8X	706065X	706069X	706058X	36625-1	36625-1
605068-3	Standard	4.56	706999-6X	706065X	706069X	706058X	36625-1	36625-1
605068-4	Standard	4.88	706999-8X	706065X	706069X	706058X	36625-1	36625-1

(7) See Ring Gear & Pinion Kits in XGI Catalog for ratio & tooth combinations.

(8) See Differential Case Assy Kits in XGI Catalog for spline data & ratios.

GM Model 70 /267 Rear Axles

Bill of Material Table

Axle			Axle Kits				Shaft & Joint Assy.	
Bill of Material	Diff. Type	Ratio	Ring Gear & Pinion Kit ⁽⁷⁾	Differential			Right Hand Shaft Assy.	Left Hand Shaft Assy.
				Case Assy. Kit ⁽⁸⁾	Case Kit	Inner Parts Kit		
1980-82 G-300 146" WB - 70B								
605002-1	Standard	4.10	706999-4X	706051X	706055X	706058X	41100-1	41100-1
605002-2	Standard	4.56	706999-6X	706052X	706056X	706058X	41100-1	41100-1
605002-3	Standard	4.10	706999-4X	706051X	706055X	706058X	41100-1	41100-1
605002-4	Standard	4.56	706999-6X	706052X	706056X	706058X	41100-1	41100-1
605002-5	Standard	4.10	706999-4X	706051X	706055X	706058X	41100-1	41100-1
1981 1/2 P-300 UPS - 70HD								
605096-1	Standard	4.10	706999-4X	706064X	706068X	706058X	41100-1	41100-1
1982-84 C/K-30 - 70HD								
605099-1	Standard	3.73	706999-2X	706906X	706908X	706058X	41100-1	41100-1
605099-2	Standard	4.10	706999-4X	706906X	706908X	706058X	41100-1	41100-1
605099-3	Standard	4.56	706999-6X	706907X	706909X	706058X	41100-1	41100-1
1982 1/2-87 P-30 Motor Home/Disc Brakes - 70HD								
605117-1	Standard	4.56	706999-6X	706907X	706909X	706058X	36625-1	36625-1
605117-2	Standard	4.88	706999-8X	706907X	706909X	706058X	36625-1	36625-1
605117-3	Standard	5.86	706999-10X	706907X	706909X	706058X	36625-1	36625-1
605117-4	Standard	5.13	706999-9X	706907X	706909X	706058X	36625-1	36625-1
605117-5	Standard	4.56	706999-6X	706907X	706909X	706058X	36625-1	36625-1
605117-6	Standard	4.88	706999-8X	706907X	706909X	706058X	36625-1	36625-1
605117-7	Standard	5.13	706999-9X	706907X	706909X	706058X	36625-1	36625-1
1983 G-300 146" WB - 70B								
605134-1	Standard	4.56	706999-6X	706951X	706953X	706058X	41100-1	41100-1
605134-2	Standard	4.10	706999-4X	706950X	706952X	706058X	41100-1	41100-1
1984-86 C/K-30 & R/V-30 - 70HD								
605203-1	Standard	3.73	706999-2X	706906X	706908X	706058X	41100-1	41100-1
605203-2	Standard	4.10	706999-4X	706906X	706908X	706058X	41100-1	41100-1
605203-3	Standard	4.56	706999-6X	706907X	706909X	706058X	41100-1	41100-1
1984-89 DRW G-Van 146" WB - 70U								
605202-1	Standard	4.10	706998-3X	706950X	706952X	706058X	41100-1	41100-1
605202-2	Standard	4.56	706998-4X	706951X	706953X	706058X	41100-1	41100-1
1985-89 P-300 UPS - 70HD								
605043-1	Standard	4.10	706999-4X	706906X	706908X	706058X	41100-1	41100-1
605043-2	Standard	4.10	706999-4X	706906X	706908X	706058X	41100-1	41100-1
605043-3	Standard	4.56	706999-6X	706907X	706909X	706058X	41100-1	41100-1
1987 SRW C-30 - 70-3HD								
605305-1	Standard	3.21	707055-1X	706065X	706069X	706058X	41100-2	41100-3
605305-3	Standard	3.42	707055-2X	706065X	706069X	706058X	41100-2	41100-3
605305-5	Standard	3.73	706999-3X	707054X	707056X	706058X	41100-2	41100-3
605305-7	Standard	4.10	706999-4X	707054X	707056X	706058X	41100-2	41100-3
1987-91 1/2 R/V-30 - 70HD								
605331-1	Standard	3.73	706999-2X	706906X	706908X	706058X	41100-1	41100-1
605331-2	Standard	4.10	706999-4X	706906X	706908X	706058X	41100-1	41100-1
605331-3	Standard	4.56	706999-6X	706907X	706909X	706058X	41100-1	41100-1
1987 1/2-89 SRW C-30 - 70-3HD								
605345-3	Standard	3.42	707055-2X	706065X	706069X	706058X	41100-2	41100-3
605345-5	Standard	3.73	706999-3X	707054X	707056X	706058X	41100-2	41100-3
605345-7	Standard	4.10	706999-4X	707054X	707056X	706058X	41100-2	41100-3

(7) See Ring Gear & Pinion Kits in XGI Catalog for ratio & tooth combinations.

(8) See Differential Case Assy Kits in XGI Catalog for spline data & ratios.

GM Model 70 /267 Rear Axles

Bill of Material Table

Axle			Axle Kits				Shaft & Joint Assy.	
Bill of Material	Diff. Type	Ratio	Ring Gear & Pinion Kit ⁽⁷⁾	Differential			Right Hand Shaft Assy.	Left Hand Shaft Assy.
				Case Assy. Kit ⁽⁸⁾	Case Kit	Inner Parts Kit		
1987 1/2-89 SRW K-30 - 70-3HD								
605346-1	Standard	3.42	707055-2X	706065X	706069X	706058X	41100-2	41100-3
605346-3	Standard	3.73	706999-3X	707054X	707056X	706058X	41100-2	41100-3
605346-5	Standard	4.10	706999-4X	707054X	707056X	706058X	41100-2	41100-3
1988 P-30 Motor Home/Disc Brakes - 70HD								
605361-1	Standard	3.73	706999-2X	706906X	706908X	706058X	41100-1	41100-1
605361-2	Standard	4.10	706999-4X	706906X	706908X	706058X	41100-1	41100-1
605361-3	Standard	4.56	706999-6X	706907X	706909X	706058X	41100-1	41100-1
1988-89 DRW G-Van 30 - 70-3HD								
605310-5	Standard	3.73	706999-3X	707054X	707056X	706058X	41100-1	41100-1
605310-7	Standard	4.10	706999-4X	707054X	707056X	706058X	41100-1	41100-1
1988-89 P-30 Motor Home/Disc Brakes - 70HD								
605363-5	Standard	4.56	706999-6X	706907X	706909X	706058X	36625-1	36625-1
605363-6	Standard	4.88	706999-8X	706907X	706909X	706058X	36625-1	36625-1
605363-7	Standard	5.13	706999-9X	706907X	706909X	706058X	36625-1	36625-1
605391-1	Standard	4.56	706999-6X	706907X	706909X	706058X	36625-1	36625-1
605391-2	Standard	4.88	706999-8X	706907X	706909X	706058X	36625-1	36625-1
1988-89 DRW C/K-30 - 70-3HD								
605397-5	Standard	3.73	706999-3X	707054X	707056X	706058X	41100-4	41100-5
605397-7	Standard	4.10	706999-4X	707054X	707056X	706058X	41100-4	41100-5
605397-9	Standard	4.56	707055-3X	707054X	707056X	706058X	41100-4	41100-5
1988-90 SRW G-Van 30 - 70-3HD								
605302-3	Standard	3.42	707055-2X	706065X	706069X	706058X	41100-6	41100-7
605302-4	Ltd Slip	3.42	707055-2X	Eaton L/S	Eaton L/S	Eaton L/S	41100-6	41100-7
605302-5	Standard	3.73	706999-3X	707054X	707056X	706058X	41100-6	41100-7
605302-6	Ltd Slip	3.73	706999-3X	Eaton L/S	Eaton L/S	Eaton L/S	41100-6	41100-7
605302-7	Standard	4.10	706999-4X	707054X	707056X	706058X	41100-6	41100-7
605302-8	Ltd Slip	4.10	706999-4X	Eaton L/S	Eaton L/S	Eaton L/S	41100-6	41100-7
1989 1/2 P-300 UPS - 70HD								
605415-1	Standard	4.56	706999-6X	707118X	706909X	707119X	41100-1	41100-1
1989 1/2 G-Van Extended - 70-3HD								
605418-3	Standard	3.42	707055-2X	706065X	706069X	706058X	41100-6	41100-7
605418-5	Standard	3.73	706999-3X	707054X	707056X	706058X	41100-6	41100-7
1989 1/2-90 P-30 Motor Home/Disc Brakes - 70HD								
605456-5	Standard	4.56	706999-6X	706907X	706909X	706058X	36625-1	36625-1
605456-6	Standard	4.88	706999-8X	706907X	706909X	706058X	36625-1	36625-1
605456-7	Standard	5.13	706999-9X	706907X	706909X	706058X	36625-1	36625-1
605457-1	Standard	4.56	706999-6X	706907X	706909X	706058X	36625-1	36625-1
605457-2	Standard	4.88	706999-8X	706907X	706909X	706058X	36625-1	36625-1
1990 DRW G-Van 146" WB - 70U								
605452-1	Standard	4.10	706998-3X	707139X	707140X	706058X	41100-1	41100-1
605452-2	Standard	4.56	706998-4X	707176X	707177X	706058X	41100-1	41100-1
1990 DRW G-Van 30 - 70-3HD								
605453-5	Standard	3.73	706999-3X	707054X	707056X	706058X	41100-1	41100-1
605453-7	Standard	4.10	706999-4X	707054X	707056X	706058X	41100-1	41100-1
1990 P-300 UPS - 70HD								
605470-1	Standard	4.56	706999-6X	707118X	706909X	707119X	41100-1	41100-1

(7) See Ring Gear & Pinion Kits in XGI Catalog for ratio & tooth combinations.

(8) See Differential Case Assy Kits in XGI Catalog for spline data & ratios.

GM Model 70 /267 Rear Axles

Bill of Material Table

Axle			Axle Kits				Shaft & Joint Assy.	
Bill of Material	Diff. Type	Ratio	Ring Gear & Pinion Kit ⁽⁷⁾	Differential			Right Hand Shaft Assy.	Left Hand Shaft Assy.
				Case Assy. Kit ⁽⁸⁾	Case Kit	Inner Parts Kit		
1990-91 1/2 SRW G-Van 30 - 70-3HD								
605449-3	Standard	3.42	707055-2X	706065X	706069X	706058X	41100-6	41100-7
605449-5	Standard	3.73	706999-3X	707054X	707056X	706058X	41100-6	41100-7
605449-7	Standard	4.10	706999-4X	707054X	707056X	706058X	41100-6	41100-7
1990-91 1/2 G-Van Extended - 70-3HD								
605454-3	Standard	3.42	707055-2X	706065X	706069X	706058X	41100-6	41100-7
605454-5	Standard	3.73	706999-3X	707054X	707056X	706058X	41100-6	41100-7
1990 1/2-91 1/2 DRW G-Van 146" WB - 70U								
605497-1	Standard	4.10	706998-3X	707139X	707140X	706058X	41100-1	41100-1
605497-2	Standard	4.56	706998-4X	707176X	707177X	706058X	41100-1	41100-1
1990 1/2-91 1/2 DRW G-Van 30 - 70-3HD								
605498-5	Standard	3.73	706999-3X	707054X	707056X	706058X	41100-1	41100-1
605498-7	Standard	4.10	706999-4X	707054X	707056X	706058X	41100-1	41100-1
1990 1/2-92 1/2 P-300 UPS - 70HD								
605493-1	Standard	4.56	706999-6X	707118X	706909X	707119X	41100-1	41100-1
1991-93 1/2 70HD								
605494-1	No Spin	4.56	706999-6X	44042	-	-	41100-1	41100-1
1993-94 P-300 UPS - 70HD								
605559-1	Standard	4.56	706999-6X	707118X	706909X	707119X	41100-1	41100-1

(7) See Ring Gear & Pinion Kits in XGI Catalog for ratio & tooth combinations.

(8) See Differential Case Assy Kits in XGI Catalog for spline data & ratios.

GM Model 70 /267 Rear Axles Variable Parts Listing

Kits & Parts - Use With All Applications							
Description & Item Number (Refer to "Exploded View" at the front of this section)			Bills of Material				
			603703	603704	603929	603970 603987	605002
1	KIT – Inner Pinion Bearing	3	706060X	706060X	706060X	706060X	706060X
2	Baffle – Pinion Bearing	5	34849	34849	34849	34849	34849
3	PKG – Diff & Pinion Bearing Shim	-	706213X	706077X	706077X	706213X	706213X
4	End Yoke Assembly (inc 11)	10	3-4-5731-1X	3-4-5731-1X	3-4-5711-1X	3-4-5711-1X	3-4-5731X
5	KIT – Carrier Cover	-	707104X	706059X	706059X	706059X	707104X
6	Carrier Cover	14	42815-2	34055	34055	34055	42815-2
7	Plug – Carrier Cover	16	43180	36472	36472	36472	43180
8	KIT – Differential Bearing	20	706047X	706070X	706070X	706070X	706047X
9	PKG – Diff Bearing Shim (inc 17)	21	706378X	706373X	706373X	706378X	706378X
10	Bolt – Drive Gear (qty 12)	23	30266	30266	30266	30266	30266
11	Shaft – Differential (std)	28	35081	35081	35081	35081	35081
12	Spacer – Differential Bearing	29	—	—	34848-28	—	—
13	KIT – Inner Wheel Bearing	34	706179X	706179X	—	706179X	706179X
14	KIT – Outer Wheel Bearing	35	706074X	706074X	—	706074X	706074X
15	Thrustwasher – Wheel Bearing	37	33734	33734	36637	33734	—
16	Spindle Nut	38	33732	33732	36635	33732	39521
17	Lockwasher – Spindle Nut	39	33733	33733	36636	33733	—
18	Spindle Nut	40	33732	33732	36635	33732	—
19	Gasket	41	36554	36554	36633	36554	36554
20	Hub Cap	42	—	—	36632	—	—
21	Key – Square	43	—	—	—	—	39522
22	Snap Ring	44	—	—	—	—	39523
			605003	605004	605005	605043	605068
1	KIT – Inner Pinion Bearing	3	706060X	706060X	706060X	706060X	706060X
2	Baffle – Pinion Bearing	5	34849	34849	34849	34849	34849
3	PKG – Diff & Pinion Bearing Shim	-	706077X	706077X	706077X	706213X	706077X
4	End Yoke Assembly (inc 11)	10	3-4-5731-1X	3-4-5711-1X	3-4-5731-1X	3-4-5711-1X	3-4-5711-1X
5	KIT – Carrier Cover	-	706059X	706059X	706059X	706966X	706059X
6	Carrier Cover	14	34055	34055	34055	30809	34055
7	Plug – Carrier Cover	16	36472	36472	36472	36472	36472
8	KIT – Differential Bearing	20	706070X	706070X	706070X	706070X	706070X
9	PKG – Diff Bearing Shim (inc 17)	21	706373X	706373X	706373X	706378X	706373X
10	Bolt – Drive Gear (qty 12)	23	30266	30266	30266	40638	30266
11	Shaft – Differential (std)	28	35081	35081	35081	35081	35081
12	Spacer – Differential Bearing	29	—	34848-28	—	—	34848-28
13	KIT – Inner Wheel Bearing	34	706179X	—	706179X	706179X	—
14	KIT – Outer Wheel Bearing	35	706074X	—	706074X	706074X	—
15	Thrustwasher – Wheel Bearing	37	—	36637	—	—	36637
16	Spindle Nut	38	39521	36635	39521	39521	36635
17	Lockwasher – Spindle Nut	39	—	36636	—	—	36636
18	Spindle Nut	40	—	36635	—	—	36635
19	Gasket	41	36554	36633	36554	36554	—
20	Hub Cap	42	—	36632	—	—	36632
21	Key – Square	43	39522	—	39522	39522	—
22	Snap Ring	44	39523	—	39523	39523	—

GM Model 70 /267 Rear Axles Variable Parts Listing

Kits & Parts - Use With All Applications							
Description & Item Number (Refer to "Exploded View" at the front of this section)			Bills of Material				
			605096	605099	605117	605134	605202
1	KIT – Inner Pinion Bearing	3	706060X	706060X	706060X	706060X	706861X
2	Baffle – Pinion Bearing	5	34849	34849	34849	34849	41550
3	PKG – Diff & Pinion Bearing Shim	-	706077X	706213X	706213X	706213X	706213X
4	End Yoke Assembly (inc 11)	10	3-4-5731-1X	3-4-5731-1X	3-4-5711X	3-4-5731-1X	3-4-5731-1X
5	KIT – Carrier Cover	-	706059X	706966X	707102X	707104X	707104X
6	Carrier Cover	14	34055	30809	42815-1	42815-2	42815-2
7	Plug – Carrier Cover	16	36472	36472	43180	43180	43180
8	KIT – Differential Bearing	20	706070X	706070X	706070X	706047X	706047X
9	PKG – Diff Bearing Shim (inc 17)	21	706373X	706378X	706378X	706378X	706378X
10	Bolt – Drive Gear (qty 12)	23	30266	40638	40638	40638	40638
11	Shaft – Differential (std)	28	35081	46640	35081	35081	35081
12	Spacer – Differential Bearing	29	—	—	—	—	—
13	KIT – Inner Wheel Bearing	34	706179X	706179X	—	706179X	706179X
14	KIT – Outer Wheel Bearing	35	706074X	706074X	—	706074X	706074X
15	Thrustwasher – Wheel Bearing	37	—	—	36637	—	—
16	Spindle Nut	38	39521	39521	36635	39521	39521
17	Lockwasher – Spindle Nut	39	—	—	36636	—	—
18	Spindle Nut	40	—	—	36635	—	—
19	Gasket	41	36554	36554	—	36554	36554
20	Hub Cap	42	—	—	36632	—	—
21	Key – Square	43	39522	39522	—	39522	39522
22	Snap Ring	44	39523	39523	—	39523	39523
			605203	605302	605305	605310	605331
1	KIT – Inner Pinion Bearing	3	706060X	706060X	706060X	706060X	706060X
2	Baffle – Pinion Bearing	5	34849	34849	34849	34849	34849
3	PKG – Diff & Pinion Bearing Shim	-	706077X	706213X	706213X	706213X	706213X
4	End Yoke Assembly (inc 11)	10	3-4-5731-1X	3-4-5731-1X	3-4-5731-1X	3-4-5731-1X	3-4-5731-1X
5	KIT – Carrier Cover	-	706966X	707104X	707104X	707104X	706966X
6	Carrier Cover	14	30809	42815-2	42815-2	42815-2	30809
7	Plug – Carrier Cover	16	36472	43180	43180	43180	36472
8	KIT – Differential Bearing	20	706070X	706070X	706070X	706070X	706070X
9	PKG – Diff Bearing Shim (inc 17)	21	706373X	706378X	706378X	706378X	706378X
10	Bolt – Drive Gear (qty 12)	23	40638	30266	30266	30266	40638
11	Shaft – Differential (std)	28	35081	35081	46640	35081	35081
12	Spacer – Differential Bearing	29	—	34848-28	—	34848-28	—
13	KIT – Inner Wheel Bearing	34	706179X	706179X	706179X	706179X	706179X
14	KIT – Outer Wheel Bearing	35	706074X	706074X	706074X	706074X	706074X
15	Thrustwasher – Wheel Bearing	37	—	—	—	—	—
16	Spindle Nut	38	39521	39521	39521	39521	39521
17	Lockwasher – Spindle Nut	39	—	—	—	—	—
18	Spindle Nut	40	—	—	—	—	—
19	Gasket	41	36554	36554	36554	36554	36554
20	Hub Cap	42	—	—	—	—	—
21	Key – Square	43	39522	39522	39522	39522	39522
22	Snap Ring	44	39523	39523	39523	39523	39523

(See next page for additional bills of material)

GM Model 70 /267 Rear Axles Variable Parts Listing

Kits & Parts - Use With All Applications							
Description & Item Number (Refer to "Exploded View" at the front of this section)			Bills of Material				
			605345 605346	605361	605363 605391	605397	605415
1	KIT – Inner Pinion Bearing	3	706060X	706060X	706060X	706060X	706060X
2	Baffle – Pinion Bearing	5	34849	34849	34849	34849	34849
3	PKG – Diff & Pinion Bearing Shim	-	706213X	706213X	706213X	706213X	706077X
4	End Yoke Assembly (inc 11)	10	3-4-5731-1X	3-4-5731-1X	3-4-5711-1X	3-4-5731-1X	3-4-5711-1X
5	KIT – Carrier Cover	-	707104X	707102X	707102X	707104X	707102X
6	Carrier Cover	14	42815-2	42815-1	42815-1	42815-2	42815-1
7	Plug – Carrier Cover	16	43180	43180	43180	43180	43180
8	KIT – Differential Bearing	20	706070X	706070X	706070X	706070X	706070X
9	PKG – Diff Bearing Shim (inc 17)	21	706378X	706378X	706378X	706378X	706373X
10	Bolt – Drive Gear (qty 12)	23	30266	40638	40638	30266	40638
11	Shaft – Differential (std)	28	35081	35081	35081	35081	43404
12	Spacer – Differential Bearing	29	34848-28	—	—	34848-28	—
13	KIT – Inner Wheel Bearing	34	706179X	706179X	—	706179X	706179X
14	KIT – Outer Wheel Bearing	35	706074X	706074X	—	706074X	706074X
15	Thrustwasher – Wheel Bearing	37	—	—	36637	—	—
16	Spindle Nut	38	39521	39521	36635	39521	39521
17	Lockwasher – Spindle Nut	39	—	—	36636	—	—
18	Spindle Nut	40	—	—	36635	—	—
19	Gasket	41	36554	36554	—	36554	36554
20	Hub Cap	42	—	—	36632	—	—
21	Key – Square	43	39522	39522	—	39522	39522
22	Snap Ring	44	39523	39523	—	39523	39523
			605418 605449	605452	605453 605454	605456 506457	605470
1	KIT – Inner Pinion Bearing	3	706060X	706060X	706060X	706060X	706060X
2	Baffle – Pinion Bearing	5	34849	41550	34849	34849	34849
3	PKG – Diff & Pinion Bearing Shim	-	706213X	706213X	706213X	706213X	706213X
4	End Yoke Assembly (inc 11)	10	3-4-5731-1X	3-4-5731-1X	3-4-5731-1X	3-4-5711-1X	3-4-5711-1X
5	KIT – Carrier Cover	-	707104X	707104X	707104X	707102X	707102X
6	Carrier Cover	14	42815-2	42815-2	42815-2	42815-1	42815-1
7	Plug – Carrier Cover	16	43180	43180	43180	43180	43180
8	KIT – Differential Bearing	20	706070X	706047X	706070X	706070X	706070X
9	PKG – Diff Bearing Shim (inc 17)	21	706378X	706378X	706378X	706378X	706378X
10	Bolt – Drive Gear (qty 12)	23	30266	40638	30266	40638	40638
11	Shaft – Differential (std)	28	35081	35081	35081	35081	43404
12	Spacer – Differential Bearing	29	34848-28	42563	34848-28	—	—
13	KIT – Inner Wheel Bearing	34	706179X	706179X	706179X	—	706179X
14	KIT – Outer Wheel Bearing	35	706074X	706074X	706074X	—	706074X
15	Thrustwasher – Wheel Bearing	37	—	—	—	36637	—
16	Spindle Nut	38	39521	39521	39521	36635	39521
17	Lockwasher – Spindle Nut	39	—	—	—	36636	—
18	Spindle Nut	40	—	—	—	36635	—
19	Gasket	41	36554	36554	36554	—	36554
20	Hub Cap	42	—	—	—	36632	—
21	Key – Square	43	39522	39522	36522	—	39522
22	Snap Ring	44	39523	39523	39523	—	39523

GM Model 70 /267 Rear Axles Variable Parts Listing

Kits & Parts - Use With All Applications							
Description & Item Number (Refer to "Exploded View" at the front of this section)			Bills of Material				
			605559	605493	605494	605497	605498
1	KIT – Inner Pinion Bearing	3	706060X	706060X	706060X	706861X	706060X
2	Baffle – Pinion Bearing	5	34849	34849	34849	34849	41550
3	PKG – Diff & Pinion Bearing Shim	-	706213X	706213X	706213X	706213X	706213X
4	End Yoke Assembly (inc 11)	10	3-4-5711-1X	3-4-5711-1X	3-4-5731-1X	3-4-5731-1X	3-4-5731-1X
5	KIT – Carrier Cover	-	707102X	707102X	706966X	707104X	707104X
6	Carrier Cover	14	42815-1	42815-1	30809	42815-2	42815-2
7	Plug – Carrier Cover	16	43180	43180	36472	43180	43180
8	KIT – Differential Bearing	20	706070X	706070X	706070X	706047X	706070X
9	PKG – Diff Bearing Shim (inc 17)	21	706378X	706378X	706378X	706378X	706378X
10	Bolt – Drive Gear (qty 12)	23	40638	40638	40638	40638	30266
11	Shaft – Differential (std)	28	43404	43404	—	35081	35081
12	Spacer – Differential Bearing	29	—	—	—	42563	34848-28
13	KIT – Inner Wheel Bearing	34	—	706179X	706179X	706179X	706179X
14	KIT – Outer Wheel Bearing	35	—	706074X	706074X	706074X	706074X
15	Thrustwasher – Wheel Bearing	37	—	—	—	—	—
16	Spindle Nut	38	39521	39521	39521	39521	39521
17	Lockwasher – Spindle Nut	39	—	—	—	—	—
18	Spindle Nut	40	—	—	—	—	—
19	Gasket	41	36554	36554	36554	36554	36554
20	Hub Cap	42	—	—	—	—	—
21	Key – Square	43	39522	39522	39522	39522	39522
22	Snap Ring	44	39523	39523	39523	39523	39523

GM /Chevrolet 1992-1998 1/2

Model 80 /286 Rear Axles for

GMT 455

P-Truck

Motor Home

GM Model 80 /286 Rear Axles Exploded View

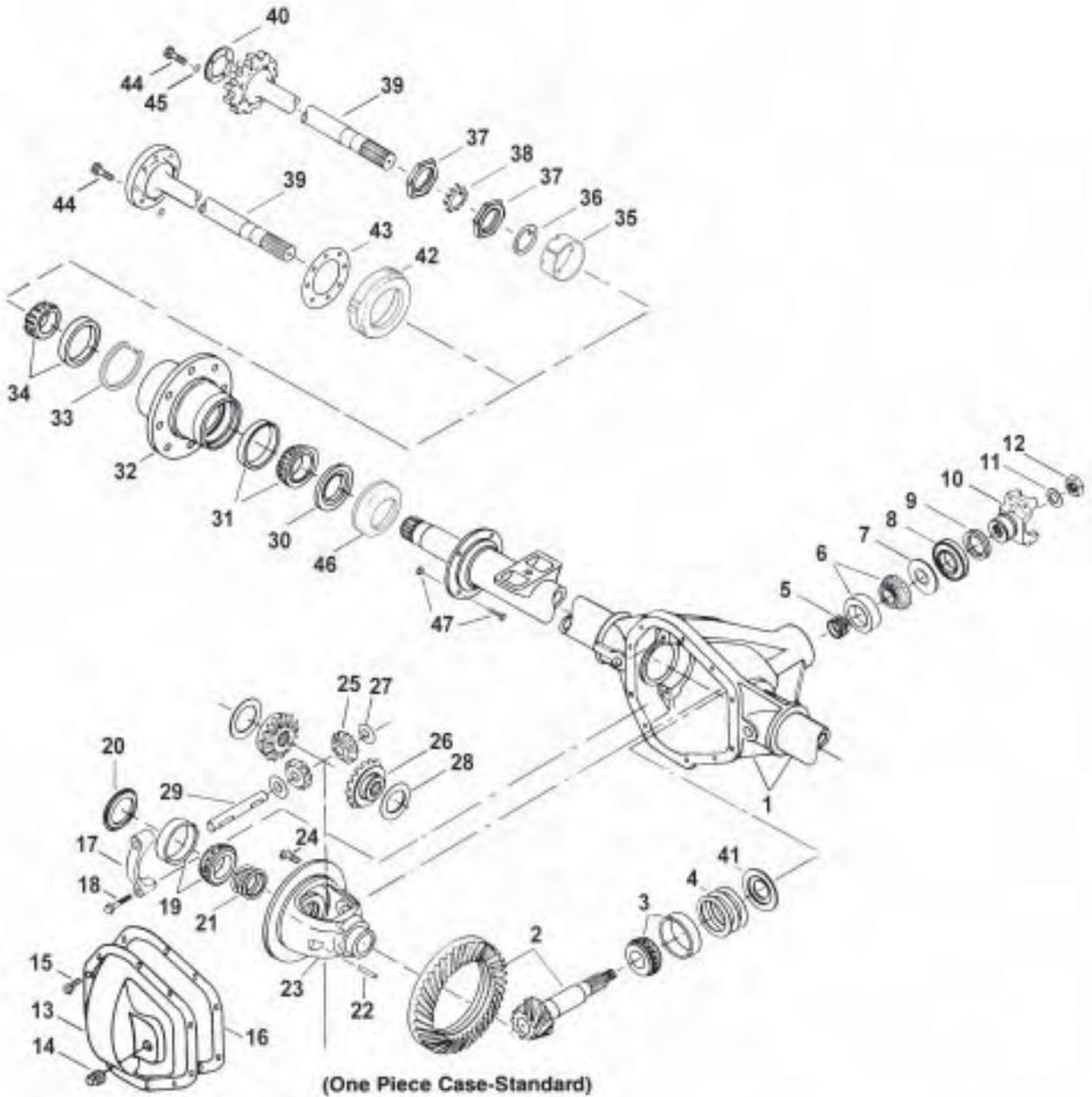

GM Model 80 /286 Rear Axles

Parts Listing

ITEM NO.	PART NUMBER	DESCRIPTION	ITEM NO.	PART NUMBER	DESCRIPTION
1	— ⁽³⁾	Housing – Axle Service	22	47024	Lock – Differential Shaft
2	— ⁽¹⁾	Drive Pinion & Gear Assembly	23	— ⁽⁴⁾	Case – Differential (std)
3	707065X	KIT – Inner Pinion Bearing	24	42433	Bolt – Drive Gear (qty 12)
	707066X	PKG – Pinion Bearing Shim (inc items 4, 5, 11, 12)	25	— ⁽²⁾	Pinion – Differential (std)
	— ⁽²⁾	PKG – Diff & Pinion Bearing Shim (inc items 4, 5, 11, 12, 21)	26	— ⁽²⁾	Gear – Differential (std)
			27	35082	Thrustwasher – Diff Pinion (std)
4	— ⁽⁴⁾	Inner Pinion Bearing Shims (see shim packages)	28	34729	Thrustwasher – Diff Gear (std)
			29	46640	Shaft – Differential (std)
5	— ⁽⁴⁾	Outer Pinion Bearing Shims (see shim packages)	30	40285	Oil Seal (Inner Wheel)
			31	— ⁽²⁾	Inner Wheel Bearing Cone
6	707064X	KIT – Outer Pinion Bearing		— ⁽²⁾	Inner Wheel Bearing Cup
7	42430	Thrustwasher – Bearing	32	— ⁽³⁾	Hub & Rotor Assembly
8	46411	Seal – Pinion Oil	33	40328	Ring – Retaining
9	231872	Slinger – End Yoke	34	— ⁽²⁾	Outer Wheel Bearing Cone
10	3-4-11081-1X	End Yoke Assembly (inc 9)		— ⁽²⁾	Outer Wheel Bearing Cup
		Bearing strap kit used w/end yoke	35	40329	Retainer – Outer Wheel Bearing
11	37104	Washer – Pinion Nut	36	36637	Retainer – Bearing Adj Ring
12	37082	Pinion Nut	37	36635	Spindle Nut
	707070X	KIT – Carrier Cover (inc items 13, 14, 15)	38	36636	Lockwasher – Spindle Nut
			39	— ⁽¹⁾	Axle Shaft
13	42434	Carrier Cover	40	— ⁽³⁾	Hub Cap (apply silicone sealant between hub cap & axle shaft)
14	36472	Plug – Carrier Cover	41	— ⁽²⁾	Baffle – Pinion Bearing
15	34822	Bolt – Carrier Cover (qty 10)	42	46471	Retainer – Outer Wheel Bearing
16	38615	RTV Silicone Sealant	43	47045	Gasket
17	— ⁽³⁾	Differential Bearing Cap	44	— ⁽²⁾	Bolt – Axle Shaft
18	48632-1	Bolt – Differential Bearing Cap	45	— ⁽²⁾	Lockwasher – Axle Shaft
19	706070X	KIT – Differential Bearing	46	46247	Grease Deflector
20	— ⁽²⁾	KIT – Differential Outboard Spacer	47	— ⁽³⁾	Nut & Bolt – Brake Mounting
21	— ⁽²⁾	PKG – Differential Bearing Shim			

- (1) See "Bill of Material Table" on next page
(2) See "Variable Parts Table" within this section
(3) Contact Vehicle Manufacturer
(4) Not Sold Separately

GM Model 80 /286 Rear Axles

Bill of Material Table

Axle			Axle Kits				Shaft & Joint Assy.	
Bill of Material	Diff. Type	Ratio	Ring Gear & Pinion Kit ⁽⁷⁾	Differential			Right Hand Shaft Assy.	Left Hand Shaft Assy.
				Case Assy. Kit ⁽⁸⁾	Case Kit	Inner Parts Kit		
1992 Motor Home/Disc Brakes								
605499-1	Standard	4.63	707060-1X	707061X	707062X	707063X	36625-1	36625-1
1992 1/2-93 1/2 GMT 455								
605524-1	Standard	4.63	707060-1X	707184X	707062X	707185X	44264-1	44264-1
605524-2	Standard	5.13	707060-4X	707184X	707062X	707185X	44264-1	44264-1
1992 1/2-93 1/2 P-Truck								
605526-1	Standard	5.13	707060-4X	707184X	707062X	707185X	44264-1	44264-1
605527-1	Standard	5.13	707060-4X	707184X	707062X	707185X	44264-1	44264-1
1993-93 1/2 GMT 455								
605575-1	Standard	4.63	707361-3X	707362X	707363X	707280X	44264-1	44264-1
605575-2	Standard	5.13	707361-4X	707362X	707363X	707280X	44264-1	44264-1
1993-95 1/2 P-Truck								
605644-1	Standard	5.13	707060-4X	707184X	707062X	707185X	44264-1	44264-1
605644-2	Standard	4.63	707060-1X	707184X	707062X	707185X	44264-1	44264-1
1993-96 1/2 Motor Home/Disc Brakes								
605601-1	Standard	4.63	707060-1X	707061X	707062X	707063X	36625-1	36625-1
605601-2	Standard	5.13	707060-4X	707061X	707062X	707063X	36625-1	36625-1
1993 1/2-95 1/2 P-Truck								
605643-1	Standard	5.13	707060-4X	707184X	707062X	707185X	44264-1	44264-1
1994 1/2-95 1/2 P-Truck								
605638-1	Standard	4.63	707060-1X	707061X	707062X	707063X	36625-1	36625-1
605712-1	Standard	4.63	707060-1X	707184X	707062X	707185X	44264-2	44264-2
605745-1	Standard	5.13	707060-4X	707184X	707062X	707185X	44264-2	44264-2
1994 1/2-95 1/2 GMT 455								
605695-1	Standard	4.63	707361-3X	707362X	707363X	707280X	44264-2	44264-2
605695-3	Standard	5.13	707361-4X	707362X	707363X	707280X	44264-2	44264-2
1995-95 1/2 GMT 455								
605649-1	Standard	4.63	707361-3X	707362X	707363X	707280X	44264-1	44264-1
605649-2	Standard	5.13	707361-4X	707362X	707363X	707280X	44264-1	44264-1
605691-1	Standard	4.63	707361-3X	707362X	707363X	707280X	44264-1	44264-1
605691-2	Standard	5.13	707361-4X	707362X	707363X	707280X	44264-1	44264-1
1995-95 1/2 Motor Home/Disc Brakes								
605719-1	Standard	4.63	707361-3X	707362X	707363X	707280X	44264-1	44264-1
1995-95 1/2 P-Truck								
605767-1	Standard	5.13	707060-4X	707184X	707062X	707185X	44264-2	44264-2
605783-1	Standard	4.63	707361-3X	707362X	707363X	707280X	44264-2	44264-2
1995 1/2-95 1/2 GMT 455								
605753-1	Standard	4.63	707361-3X	707362X	707363X	707280X	44264-1	44264-1
605753-2	Standard	5.13	707361-4X	707362X	707363X	707280X	44264-1	44264-1
1996-96 1/2 P-Truck								
605810-1	Standard	5.13	707060-4X	707184X	707062X	707185X	44264-1	44264-1
605811-1	Standard	5.13	707060-4X	707184X	707062X	707185X	44264-1	44264-1
605811-2	Standard	4.63	707060-1X	707184X	707062X	707185X	44264-1	44264-1
605817-1	Standard	4.63	707361-3X	707362X	707363X	707280X	44264-2	44264-2

(7) See Ring Gear & Pinion Kits in XGI Catalog for ratio & tooth combinations.

(8) See Differential Case Assy Kits in XGI Catalog for spline data & ratios.

GM Model 80 /286 Rear Axles

Bill of Material Table

Axle			Axle Kits				Shaft & Joint Assy.	
Bill of Material	Diff. Type	Ratio	Ring Gear & Pinion Kit ⁽⁷⁾	Differential			Right Hand Shaft Assy.	Left Hand Shaft Assy.
				Case Assy. Kit ⁽⁸⁾	Case Kit	Inner Parts Kit		
1996-97 P-Truck								
605818-1	Standard	5.13	707060-4X	707184X	707062X	707185X	44264-2	44264-2
1996-98 P-Truck								
605812-1	Standard	5.13	707060-4X	707184X	707062X	707185X	44264-2	44264-2
605814-1	Standard	4.63	707060-1X	707184X	707062X	707185X	44264-2	44264-2
605815-1	Standard	4.63	707060-1X	707061X	707062X	707063X	36625-1	36625-1
605816-1	Standard	4.63	707060-1X	707061X	707062X	707063X	36625-1	36625-1
1996-98 GMT 455								
605868-1	Standard	4.63	707361-3X	707362X	707363X	707280X	44264-1	44264-1
605868-2	Standard	5.13	707361-4X	707362X	707363X	707280X	44264-1	44264-1
605869-1	Standard	4.63	707361-3X	707362X	707363X	707280X	44264-2	44264-2
605869-2	Standard	5.13	707361-4X	707362X	707363X	707280X	44264-2	44264-2
1996-99 GMT 455								
605867-1	Standard	4.63	707361-3X	707362X	707363X	707280X	44264-1	44264-1
605867-2	Standard	5.13	707361-4X	707362X	707363X	707280X	44264-1	44264-1
1996 1/2 P-Truck								
605813-1	Standard	4.63	707361-3X	707362X	707363X	707280X	44264-1	44264-1
1996 1/2 GMT 455								
605858-1	Standard	4.63	707361-3X	707362X	707363X	707280X	44264-1	44264-1
605858-2	Standard	5.13	707361-4X	707362X	707363X	707280X	44264-1	44264-1
1996 1/2-97 P-Truck								
605838-1	Standard	5.13	707060-4X	707184X	707062X	707185X	47037-1	47037-1
605839-1	Standard	5.13	707060-4X	707184X	707062X	707185X	47037-1	47037-1
605840-1	Standard	4.63	707361-3X	707362X	707363X	707280X	47037-1	47037-1
605896-1	Standard	4.63	707361-3X	707362X	707363X	707280X	47037-2	47037-2
1997-2000 P-Truck								
606040-1	Standard	5.13	707361-4X	707362X	707363X	707280X	47037-1	47037-1
606041-1	Standard	5.13	707361-4X	707362X	707363X	707280X	47037-1	47037-1
606042-1	Standard	4.63	707361-3X	707362X	707363X	707280X	47037-1	47037-1
606043-1	Standard	4.63	707361-3X	707362X	707363X	707280X	47037-2	47037-2
1998 1/2-99 GMT 455								
606073-1	Standard	4.63	707361-3X	707362X	707363X	707280X	44264-1	44264-1
606073-2	Standard	5.13	707361-4X	707362X	707363X	707280X	44264-1	44264-1
606074-1	Standard	4.63	707361-3X	707362X	707363X	707280X	44264-2	44264-2
606074-2	Standard	5.13	707361-4X	707362X	707363X	707280X	44264-2	44264-2
606123-1	Standard	4.63	707361-3X	707362X	707363X	707280X	44264-2	44264-2
606123-2	Standard	5.13	707361-4X	707362X	707363X	707280X	44264-2	44264-2

(7) See Ring Gear & Pinion Kits in XGI Catalog for ratio & tooth combinations.

(8) See Differential Case Assy Kits in XGI Catalog for spline data & ratios.

GM Model 80 /286 Rear Axles Variable Parts Listing

Kits & Parts - Use With All Applications							
Description & Item Number (Refer to "Exploded View" at the front of this section)			Bills of Material				
			605499	605524 605526 605527	605575	605601	605638
1	PKG – Diff & Pinion Bearing Shim	-	708036	708036	707365X	708036	707365X
2	KIT – Differential Outboard Spacer	20	707069X	707069X	701133X	707069X	701133X
3	PKG – Differential Bearing Shim	21	708035	708035	707364X	708035	707364X
4	Pinion – Differential (std)	25	42413	42413	44845	42413	42413
5	Gear – Differential (std)	26	42411	43652	44844	42411	42411
6	Inner Wheel Bearing Cone	31	565996	565996	565996	565996	565996
7	Inner Wheel Bearing Cup	-	565995	565995	565995	565995	565995
8	Outer Wheel Bearing Cone	34	550362	550362	550362	550362	550362
9	Outer Wheel Bearing Cup	-	565994	565994	565994	565994	565994
10	Baffle – Pinion Bearing	41	—	44192	44192	—	—
11	Bolt – Axle Shaft	44	36634	36634	36634	36634	36634
12	Lockwasher – Axle Shaft	45	500357-10	500357-10	500357-10	500357-10	500357-10
			605643 605644	605649 605691 605695	605712	605719	605745
1	PKG – Diff & Pinion Bearing Shim	-	708036	707365X	708036	707365X	708036
2	KIT – Differential Outboard Spacer	20	707069X	701133X	707069X	701133X	707069X
3	PKG – Differential Bearing Shim	21	708035	707364X	708035	707364X	708035
4	Pinion – Differential (std)	25	42413	44845	42413	44845	42413
5	Gear – Differential (std)	26	43652	44844	43652	44844	43652
6	Inner Wheel Bearing Cone	31	565996	565996	565996	565996	565996
7	Inner Wheel Bearing Cup	-	565995	565995	565995	565995	565995
8	Outer Wheel Bearing Cone	34	550362	550362	550362	550362	550362
9	Outer Wheel Bearing Cup	-	565994	565994	565994	565994	565994
10	Baffle – Pinion Bearing	41	44192	44192	—	44192	—
11	Bolt – Axle Shaft	44	36634	36634	36634	36634	36634
12	Lockwasher – Axle Shaft	45	500357-10	500357-10	500357-10	500357-10	500357-10
			605753	605767	605783	605810 605811	605812
1	PKG – Diff & Pinion Bearing Shim	-	707365X	708036	707365X	708036	708036
2	KIT – Differential Outboard Spacer	20	701133X	707069X	701133X	707069X	707069X
3	PKG – Differential Bearing Shim	21	707364X	708035	707364X	708035	708035
4	Pinion – Differential (std)	25	44845	42413	44845	42413	42413
5	Gear – Differential (std)	26	44844	43652	44844	43652	43652
6	Inner Wheel Bearing Cone	31	565996	565996	565996	565996	565996
7	Inner Wheel Bearing Cup	-	565995	565995	565995	565995	565995
8	Outer Wheel Bearing Cone	34	550362	550362	550362	550362	550362
9	Outer Wheel Bearing Cup	-	565994	565994	565994	565994	565994
10	Baffle – Pinion Bearing	41	44192	—	44192	44192	—
11	Bolt – Axle Shaft	44	36634	36634	36634	36634	36634
12	Lockwasher – Axle Shaft	45	500357-10	500357-10	500357-10	500357-10	500357-10

GM Model 80 /286 Rear Axles Variable Parts Listing



Kits & Parts - Use With All Applications							
Description & Item Number (Refer to "Exploded View" at the front of this section)			Bills of Material				
			605813	605814	605815	605816	605817
1	PKG – Diff & Pinion Bearing Shim	-	707365X	708036	708036	707365X	707365X
2	KIT – Differential Outboard Spacer	20	701133X	707069X	707069X	701133X	701133X
3	PKG – Differential Bearing Shim	21	707364X	708035	708035	707364X	707364X
4	Pinion – Differential (std)	25	44845	42413	42413	42413	44845
5	Gear – Differential (std)	26	44844	43652	42411	42411	44844
6	Inner Wheel Bearing Cone	31	565996	565996	565996	565996	565996
7	Inner Wheel Bearing Cup	-	565995	565995	565995	565995	565995
8	Outer Wheel Bearing Cone	34	550362	550362	550362	550362	550362
9	Outer Wheel Bearing Cup	-	565994	565994	565994	565994	565994
10	Baffle – Pinion Bearing	41	44192	—	—	—	44192
11	Bolt – Axle Shaft	44	36634	36634	36634	36634	36634
12	Lockwasher – Axle Shaft	45	500357-10	500357-10	500357-10	500357-10	500357-10
			605818	605838 605839	605840	605858 605867 605868 605869	605896 606040 606041 606042 606043
1	PKG – Diff & Pinion Bearing Shim	-	708036	708036	707365X	707365X	707365X
2	KIT – Differential Outboard Spacer	20	707069X	707069X	701133X	701133X	701133X
3	PKG – Differential Bearing Shim	21	708035	708035	707364X	707364X	707364X
4	Pinion – Differential (std)	25	42413	42413	44845	44845	44845
5	Gear – Differential (std)	26	43652	43652	44844	44844	44844
6	Inner Wheel Bearing Cone	31	565996	565962	565962	565996	565962
7	Inner Wheel Bearing Cup	-	565995	550234	550234	565995	550234
8	Outer Wheel Bearing Cone	34	550362	566057	566057	550362	566057
9	Outer Wheel Bearing Cup	-	565994	565939	565939	565994	565939
10	Baffle – Pinion Bearing	41	—	44192	44192	44192	44192
11	Bolt – Axle Shaft	44	36634	45720	45720	36634	45720
12	Lockwasher – Axle Shaft	45	500357-10	—	—	500357-10	—
			606073 606074 606123				
1	PKG – Diff & Pinion Bearing Shim	-	707365X				
2	KIT – Differential Outboard Spacer	20	701133X				
3	PKG – Differential Bearing Shim	21	707364X				
4	Pinion – Differential (std)	25	44845				
5	Gear – Differential (std)	26	44844				
6	Inner Wheel Bearing Cone	31	565996				
7	Inner Wheel Bearing Cup	-	565995				
8	Outer Wheel Bearing Cone	34	550362				
9	Outer Wheel Bearing Cup	-	565994				
10	Baffle – Pinion Bearing	41	44192				
11	Bolt – Axle Shaft	44	36634				
12	Lockwasher – Axle Shaft	45	500357-10				

Jeep / Eagle 1978-1998 1/2

Model 30 /181 Front Axles for

XJ (Cherokee /Comanche)

YJ /TJ (Wrangler)

ZJ (Grand Cherokee)

CJ (Civilian Jeep)

Jeep Model 30 /181 Front Exploded View

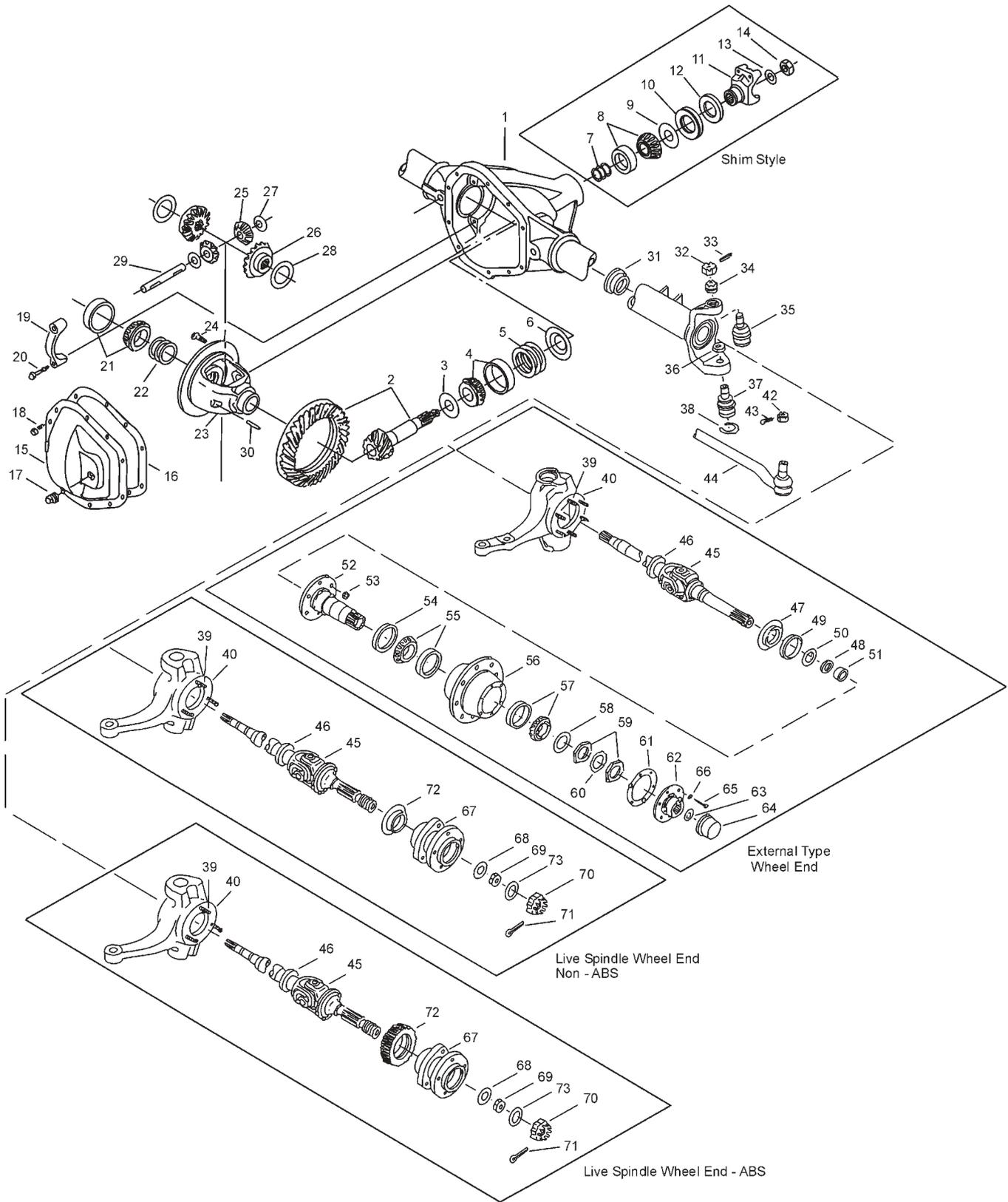

Jeep Model 30 /181 Front Parts Listing

ITEM NO.	PART NUMBER	DESCRIPTION	ITEM NO.	PART NUMBER	DESCRIPTION
1	— ⁽³⁾	Housing – Axle Service	34	— ⁽²⁾	Adjusting Split Ring
2	— ⁽¹⁾	Drive Gear & Pinion Assembly	35	— ⁽²⁾	Socket Assembly
3	30764	Slinger – Inner Pinion Bearing	36	— ⁽²⁾	Nut – Hex Jam / Slotted
4	706015X	KIT – Inner Pinion Bearing	37	— ⁽²⁾	Socket Assembly
	706938X	PKG – Diff & Pinion Bearing Shim (inc items 5, 7, 12, 13, 16, 22)	38	— ⁽²⁾	Snap Ring
	706936X	PKG – Pinion Bearing Shim (inc items 5, 7, 12, 13, 16)	39	— ⁽²⁾	Bolt – Knuckle
5	—	Inner Pinion Bearing Shims (see shim packages)	40	— ⁽²⁾	Right Knuckle
			41	— ⁽²⁾	Left Knuckle
6	32349	Baffle – Pinion Bearing	42	— ⁽³⁾	Nut – Hex Slotted
7	—	Outer Pinion Bearing Shims (see shim packages)	43	— ⁽³⁾	Cotter Pin
8	706030X	KIT – Outer Pinion Bearing	44	— ⁽⁵⁾	Tie Rod Assembly
9	13575	Slinger – Outer Pinion Bearing	45	— ⁽¹⁾	Shaft & Joint Assembly
10	— ⁽²⁾	Seal – Pinion Oil	46	— ⁽²⁾	Slinger – Spindle Yoke (Inner)
11	— ⁽²⁾	End Yoke or Assembly (inc 12)	47	— ⁽²⁾	Slinger – Spindle Yoke (Outer)
12	— ⁽²⁾	Slinger – End Yoke		— ⁽²⁾	KIT – Spindle Seal & Bearing (inc items 48, 49, 50, 51)
13	30186	Washer – Pinion Nut		— ⁽²⁾	KIT – Spindle (inc items 48, 49, 50, 51, 52)
14	30185	Pinion Nut	48	— ⁽²⁾	Oil Seal
	— ⁽²⁾	KIT – Carrier Cover (inc item 15, 16, 17, 18)	49	— ⁽²⁾	Oil Seal (block vee)
15	— ⁽²⁾	Carrier Cover	50	— ⁽²⁾	Spacer – Wheel Bearing Spindle
16	— ⁽²⁾	Gasket/RTV Silicone Sealant	51	— ⁽²⁾	Needle Bearing Assembly
17	— ⁽²⁾	Plug – Carrier Cover	52	— ⁽²⁾	Spindle – Wheel Bearing
18	34279	Bolt – Carrier Cover	53	— ⁽³⁾	Nut – Brake Mounting
19	— ⁽³⁾	Differential Bearing Cap	54	— ⁽³⁾	Oil Seal
20	48631-1	Bolt – Differential Bearing Cap	55	— ⁽²⁾	KIT – Inner Wheel Bearing
21	706016X	KIT – Differential Bearing	56	— ⁽³⁾	Wheel Hub
22	706937X	KIT – Differential Brg Shim (inc items 16, 54, 55, 63,70)	57	— ⁽²⁾	KIT – Outer Wheel Bearing
23	— ⁽⁴⁾	Case – Differential (std)	58	— ⁽²⁾	Lockwasher – Wheel Bearing
24	41221	Bolt – Drive Gear (qty 10)	59	— ⁽²⁾	Nut – Wheel Bearing
25	32926	Pinion – Differential (std)	60	— ⁽²⁾	Lockwasher – Wheel Bearing Nut
26	— ⁽²⁾	Gear – Differential (std)	61	— ⁽²⁾	Gasket – Drive Flange
27	34096	Thrustwasher – Diff Pinion (std)	62	— ⁽²⁾	Flange – Axle Drive
28	— ⁽²⁾	Thrustwasher – Diff Gear (std)	63	— ⁽²⁾	Snap Ring
29	41648	Shaft – Differential (std)	64	— ⁽²⁾	Hub Cap
30	13449	Lock – Differential Shaft	65	— ⁽³⁾	Bolt
31	46470	Oil Seal	66	— ⁽²⁾	Lockwasher
	— ⁽²⁾	KIT – Right Knuckle Assembly	67	— ⁽²⁾	Hub Assembly
	— ⁽²⁾	KIT – Left Knuckle Assembly	68	40596	Washer – Flat
	— ⁽²⁾	KIT – Socket Assembly	69	40597	Nut – Hex
32	— ⁽²⁾	Nut – Slotted	70	40598	Retainer Nut
33	500024-6	Cotter Pin	71	500025-10	Cotter Pin
			72	— ⁽²⁾	Tone Ring (ABS)/Slinger
			73	— ⁽²⁾	Spring – Wave Washer

(1) See "Bill of Material Table" on next page

(2) See "Variable Parts Table" within this section

(3) Contact Vehicle Manufacturer

(4) Not Sold Separately

(5) See Spicer Chassis Catalog for part number and additional steering parts

Jeep Model 30 /181 Front Bill of Material Table

Axle			Axle Kits				Shaft & Joint Assy.	
Bill of Material	Diff. Type	Ratio	Ring Gear & Pinion Kit ⁽⁷⁾	Differential			Right Hand Shaft Assy.	Left Hand Shaft Assy.
				Case Assy. Kit ⁽⁸⁾	Case Kit	Inner Parts Kit		
1978 CJ5/CJ7 - External Type Wheel End								
603732-2	Standard	3.54	706503-2X	706003X	706007X	706010X	28179-3X	28179-4X
603732-3	Standard	4.10	706503-4X	706004X	706008X	706010X	28179-3X	28179-4X
603732-4	Standard	4.10	706503-4X	706004X	706008X	706010X	28179-3X	28179-4X
603732-5	Standard	3.54	706503-2X	706003X	706007X	706010X	28179-3X	28179-4X
1979 CJ5/CJ7 - External Type Wheel End								
610053-1	Standard	3.07	706503-10X	706003X	706007X	706010X	28179-3X	28179-4X
610053-2	Standard	3.54	706503-2X	706003X	706007X	706010X	28179-3X	28179-4X
610053-3	Standard	4.10	706503-4X	706004X	706008X	706010X	28179-3X	28179-4X
610053-4	Standard	4.10	706503-4X	706004X	706008X	706010X	28179-3X	28179-4X
610053-5	Standard	3.54	706503-2X	706003X	706007X	706010X	28179-3X	28179-4X
610053-6	Standard	3.07	706503-10X	706003X	706007X	706010X	28179-3X	28179-4X
1980 CJ5/CJ7 - External Type Wheel End								
610086-1	Standard	3.07	706503-10X	706003X	706007X	706010X	28179-3X	28179-4X
610086-2	Standard	3.54	706503-2X	706003X	706007X	706010X	28179-3X	28179-4X
610086-3	Standard	4.10	706503-4X	706004X	706008X	706010X	28179-3X	28179-4X
610086-4	Standard	4.10	706503-4X	706004X	706008X	706010X	28179-3X	28179-4X
610086-5	Standard	3.54	706503-2X	706003X	706007X	706010X	28179-3X	28179-4X
610086-10	Standard	2.72	700128-2	706003X	706007X	706010X	28179-3X	28179-4X
610086-11	Standard	2.72	700128-2	706003X	706007X	706010X	28179-3X	28179-4X
610086-12	Standard	3.07	706503-10X	706003X	706007X	706010X	28179-3X	28179-4X
1981 CJ5/CJ7 - External Type Wheel End								
610136-1	Standard	3.73	706503-3X	706004X	706008X	706010X	28179-3X	28179-4X
610136-2	Standard	3.73	706503-3X	706004X	706008X	706010X	28179-3X	28179-4X
610136-3	Standard	3.31	706503-1X	706003X	706007X	706010X	28179-3X	28179-4X
610136-4	Standard	3.31	706503-1X	706003X	706007X	706010X	28179-3X	28179-4X
610136-5	Standard	2.72	700128-2	706003X	706007X	706010X	28179-3X	28179-4X
610136-6	Standard	2.72	700128-2	706003X	706007X	706010X	28179-3X	28179-4X
610136-7	Standard	3.54	706503-2X	706003X	706007X	706010X	28179-3X	28179-4X
1981 1/2 CJ5/CJ7 - External Type Wheel End								
610154-1	Standard	2.72	700128-2	706003X	706007X	706010X	28179-3X	28179-4X
610154-2	Standard	3.31	706503-1X	706003X	706007X	706010X	28179-3X	28179-4X
610154-3	Standard	3.73	706503-3X	706004X	706007X	706010X	28179-3X	28179-4X
610154-4	Standard	3.73	706503-3X	706004X	706007X	706010X	28179-3X	28179-4X
610154-5	Standard	3.31	706503-1X	706003X	706007X	706010X	28179-3X	28179-4X
610154-6	Standard	2.72	700128-2	706003X	706007X	706010X	28179-3X	28179-4X
610154-7	Standard	3.54	706503-2X	706003X	706007X	706010X	28179-3X	28179-4X
1982-83 CJ5 - External Type Wheel End								
610156-1	Standard	2.72	700128-2	706003X	706007X	706010X	28179-3X	28179-4X
610156-2	Standard	3.31	706503-1X	706003X	706007X	706010X	28179-3X	28179-4X
610156-5	Standard	3.31	706503-1X	706003X	706007X	706010X	28179-3X	28179-4X
610156-6	Standard	2.72	700128-2	706003X	706007X	706010X	28179-3X	28179-4X
610156-7	Standard	3.54	706503-2X	706003X	706007X	706010X	28179-3X	28179-4X
610156-8	Standard	4.10	706503-4X	706004X	706008X	706010X	28179-3X	28179-4X
610156-9	Standard	4.10	706503-4X	706004X	706008X	706010X	28179-3X	28179-4X
610156-10	Standard	4.56	706503-5X	706004X	706008X	706010X	28179-3X	28179-4X

NOTE: All Ring & Pinion Kits with base number 706930 are reverse spiral bevel
 (7) See Ring Gear & Pinion Kits in XGI Catalog for ratio & tooth combinations.
 (8) See Differential Case Assy Kits in XGI Catalog for spline data & ratios.

Jeep Model 30 /181 Front Bill of Material Table

Axle			Axle Kits				Shaft & Joint Assy.	
Bill of Material	Diff. Type	Ratio	Ring Gear & Pinion Kit ⁽⁷⁾	Differential			Right Hand Shaft Assy.	Left Hand Shaft Assy.
				Case Assy. Kit ⁽⁸⁾	Case Kit	Inner Parts Kit		
1982-87 CJ7/CJ8 - External Type Wheel End								
610164-1	Standard	2.72	700128-2	706003X	706007X	706010X	28179-7X	28179-8X
610164-2	Standard	3.31	706503-1X	706003X	706007X	706010X	28179-7X	28179-8X
610164-5	Standard	3.31	706503-1X	706003X	706007X	706010X	28179-7X	28179-8X
610164-6	Standard	2.72	700128-2	706003X	706007X	706010X	28179-7X	28179-8X
610164-7	Standard	3.54	706503-2X	706003X	706007X	706010X	28179-7X	28179-8X
610164-8	Standard	4.10	706503-4X	706004X	706008X	706010X	28179-7X	28179-8X
610164-9	Standard	4.10	706503-4X	706004X	706008X	706010X	28179-7X	28179-8X
610164-10	Standard	4.56	706503-5X	706004X	706008X	706010X	28179-7X	28179-8X
610164-11	Standard	4.56	706503-5X	706004X	706008X	706010X	28179-7X	28179-8X
1985 XJ Non-Disconnect, Cardan - Live Spindle Wheel End								
610206-1	Standard	3.73	706930-5X	706932X	706934X	706935X	75814-2X	75814-1X
610206-5	Standard	3.31	706930-3X	706931X	706933X	706935X	75814-2X	75814-1X
1985 XJ Non-Disconnect, CV, System Sentry - Live Spindle Wheel End								
610221-1	Standard	3.73	706930-5X	706932X	706934X	706935X	75814-2X	75814-1X
610221-5	Standard	3.31	706930-3X	706931X	706933X	706935X	75814-2X	75814-1X
610221-7	Standard	3.54	706930-8X	706931X	706933X	706935X	75814-2X	75814-1X
610221-11	Standard	4.10	706930-4X	706932X	706934X	706935X	75814-2X	75814-1X
1985 XJ 4X2, System Sentry (Dead Front)								
610237	-	-	-	-	-	-	-	-
1985-86 XJ Non-Disconnect, CV - Live Spindle Wheel End								
610222-1	Standard	3.54	706930-8X	706931X	706933X	706935X	75814-2X	75814-1X
610222-2	Standard	3.73	706930-5X	706932X	706934X	706935X	75814-2X	75814-1X
610222-3	Standard	4.10	706930-4X	706932X	706934X	706935X	75814-2X	75814-1X
610222-9	Standard	3.31	706930-3X	706931X	706933X	706935X	75814-2X	75814-1X
610222-19	Standard	3.73	706930-5X	706931X	706934X	706935X	75814-2X	75814-1X
1985-86 XJ 4X2, System Sentry (Dead Front)								
610234	-	-	-	-	-	-	-	-
1985-87 XJ Non-Disconnect, Cardan - Live Spindle Wheel End								
610183-1	Standard	3.54	706930-8X	706931X	706933X	706935X	75814-2X	75814-1X
610183-2	Standard	3.73	706930-5X	706932X	706934X	706935X	75814-2X	75814-1X
610183-3	Standard	4.10	706930-4X	706932X	706934X	706935X	75814-2X	75814-1X
610183-5	Standard	4.56	706930-6X	706932X	706934X	706935X	75814-2X	75814-1X
610183-8	Standard	3.07	706930-2X	706931X	706933X	706935X	75814-2X	75814-1X
610183-9	Standard	3.31	706930-3X	706931X	706933X	706935X	75814-2X	75814-1X
1986 CJ7, LH Steering - External Type Wheel End								
610244-1	Standard	2.72	700128-2	706003X	706007X	706010X	28179-7X	28179-8X
610244-2	Standard	3.31	706503-1X	706003X	706007X	706010X	28179-7X	28179-8X
610244-5	Standard	3.31	706503-1X	706003X	706007X	706010X	28179-7X	28179-8X
610244-6	Standard	2.72	700128-2	706003X	706007X	706010X	28179-7X	28179-8X
610244-7	Standard	3.54	706503-2X	706003X	706007X	706010X	28179-7X	28179-8X
610244-8	Standard	4.10	706503-4X	706004X	706008X	706010X	28179-7X	28179-8X
610244-9	Standard	4.10	706503-4X	706004X	706008X	706010X	28179-7X	28179-8X
610244-10	Standard	4.56	706503-5X	706004X	706008X	706010X	28179-7X	28179-8X
610244-12	Standard	2.72	700128-2	706003X	706007X	706010X	28179-7X	28179-8X
610244-13	Standard	3.31	706503-1X	706003X	706007X	706010X	28179-7X	28179-8X
610244-16	Standard	3.31	706503-1X	706003X	706007X	706010X	28179-7X	28179-8X
610244-17	Standard	2.72	700128-2	706003X	706007X	706010X	28179-7X	28179-8X

Continued on next page

NOTE: All Ring & Pinion Kits with base number 706930 are reverse spiral bevel

(7) See Ring Gear & Pinion Kits in XGI Catalog for ratio & tooth combinations.

(8) See Differential Case Assy Kits in XGI Catalog for spline data & ratios.

Jeep Model 30 /181 Front Bill of Material Table

Axle			Axle Kits				Shaft & Joint Assy.	
Bill of Material	Diff. Type	Ratio	Ring Gear & Pinion Kit ⁽⁷⁾	Differential			Right Hand Shaft Assy.	Left Hand Shaft Assy.
				Case Assy. Kit ⁽⁸⁾	Case Kit	Inner Parts Kit		
1986 CJ7, LH Steering - External Type Wheel End (Continued)								
610244-18	Standard	3.54	706503-2X	706003X	706007X	706010X	28179-7X	28179-8X
610244-19	Standard	4.10	706503-4X	706004X	706008X	706010X	28179-7X	28179-8X
610244-20	Standard	4.10	706503-4X	706004X	706008X	706010X	28179-7X	28179-8X
610244-21	Standard	4.56	706503-5X	706004X	706008X	706010X	28179-7X	28179-8X
1986 YJ Non-Disconnect - Live Spindle Wheel End								
610269-1	Standard	3.07	706930-2X	706819X	706007X	706820X	75814-2X	75814-1X
610269-2	Standard	4.10	706930-4X	706932X	706008X	706820X	75814-2X	75814-1X
1986-89 XJ 4X2 (Dead Front)								
610256	-	-	-	-	-	-	-	-
1987-88 YJ Non-Disconnect - Live Spindle Wheel End								
610282-1	Standard	3.07	706930-2X	706819X	706007X	706820X	75814-2X	75814-1X
610282-2	Standard	4.10	706930-4X	706932X	706008X	706820X	75814-2X	75814-1X
610282-3	Standard	3.54	706930-8X	706819X	706007X	706820X	75814-2X	75814-1X
610282-4	Standard	3.55	706930-8X	706819X	706007X	706820X	75814-2X	75814-1X
1987 1/2-88 XJ Non-Disconnect - Live Spindle Wheel End								
610280-1	Standard	3.54	706930-8X	706931X	706933X	706935X	75814-2X	75814-1X
610280-2	Standard	3.73	706930-5X	706932X	706934X	706935X	75814-2X	75814-1X
610280-3	Standard	4.10	706930-4X	706932X	706934X	706935X	75814-2X	75814-1X
610280-4	Standard	4.56	706930-6X	706932X	706934X	706935X	75814-2X	75814-1X
610280-5	Standard	3.07	706930-2X	706931X	706933X	706935X	75814-2X	75814-1X
610280-6	Standard	3.31	706930-3X	706931X	706933X	706935X	75814-2X	75814-1X
610280-7	Standard	3.55	706930-8X	706931X	706933X	706935X	75814-2X	75814-1X
1987 1/2-88 XJ Non-Disconnect, ABS, Anti Skid - Live Spindle Wheel End								
610294-7	Standard	3.55	706930-8X	706931X	706933X	706935X	74286-2X	74286-1X
1988 XJ Non-Disconnect, Valeo Export - Live Spindle Wheel End								
610334-1	Standard	3.55	706930-8X	706931X	706933X	706935X	75814-2X	75814-1X
1988 1/2-89 XJ Non-Disconnect - Live Spindle Wheel End								
610322-3	Standard	4.10	706930-4X	706932X	706934X	706935X	75814-2X	75814-1X
610322-7	Standard	3.55	706930-8X	706931X	706933X	706935X	75814-2X	75814-1X
1988 1/2-89 YJ Non-Disconnect - Live Spindle Wheel End								
610324-1	Standard	3.07	706930-2X	706819X	706007X	706820X	75814-2X	75814-1X
610324-2	Standard	4.10	706930-4X	706932X	706008X	706820X	75814-2X	75814-1X
610324-4	Standard	3.55	706930-8X	706819X	706007X	706820X	75814-2X	75814-1X
1988 1/2-89 XJ Non-Disconnect, ABS, Anti Skid - Live Spindle Wheel End								
610327-7	Standard	3.55	706930-8X	706931X	706933X	706935X	74286-2X	74286-1X
1988 1/2-89 XJ Non-Disconnect, Valeo Export - Live Spindle Wheel End								
610337-1	Standard	3.55	706930-8X	706931X	706933X	706935X	75814-2X	75814-1X
1990-90 1/2 XJ Non-Disconnect, Valeo Export - Live Spindle Wheel End								
610340-1	Standard	3.55	706930-8X	707158X	706933X	707160X	75814-2X	75814-1X
1990-91 1/2 XJ Non-Disconnect - Live Spindle Wheel End								
610318-3	Standard	4.10	706930-4X	707159X	706934X	707160X	73619-4X	73619-3X
610318-5	Standard	3.07	706930-2X	707158X	706933X	707160X	73619-4X	73619-3X
610318-7	Standard	3.55	706930-8X	707158X	706933X	707160X	73619-4X	73619-3X
1990-91 1/2 XJ Non-Disconnect, ABS - Live Spindle Wheel End								
610336-7	Standard	3.55	706930-8X	707158X	706933X	707160X	74286-2X	74286-1X

NOTE: All Ring & Pinion Kits with base number 706930 are reverse spiral bevel
 (7) See Ring Gear & Pinion Kits in XGI Catalog for ratio & tooth combinations.
 (8) See Differential Case Assy Kits in XGI Catalog for spline data & ratios.

Jeep Model 30 /181 Front Bill of Material Table

Axle			Axle Kits				Shaft & Joint Assy.	
Bill of Material	Diff. Type	Ratio	Ring Gear & Pinion Kit ⁽⁷⁾	Differential			Right Hand Shaft Assy.	Left Hand Shaft Assy.
				Case Assy. Kit ⁽⁸⁾	Case Kit	Inner Parts Kit		
1990-91 1/2 YJ Non-Disconnect - Live Spindle Wheel End								
610320-1	Standard	3.07	706930-2X	707158X	706007X	707160X	75814-2X	75814-1X
610320-2	Standard	4.10	706930-4X	706932X	706008X	706820X	75814-2X	75814-1X
610320-4	Standard	3.55	706930-8X	707158X	706007X	707160X	75814-2X	75814-1X
610320-5	Standard	3.07	706930-2X	707158X	706007X	706160X	75814-2X	75814-1X
610320-6	Standard	4.10	706930-4X	706932X	706008X	706820X	75814-2X	75814-1X
610320-7	Standard	3.55	706930-8X	707158X	706007X	707160X	75814-2X	75814-1X
1990 1/2-91 1/2 XJ 4X2 (Dead Front)								
610351	-	-	-	-	-	-	-	-
1991 XJ Non-Disconnect								
610373-1	Standard	3.73	706930-8X	707158X	706933X	707160X	75814-2X	75814-1X
1991 XJ 4X2 (Dead Front)								
610375	-	-	-	-	-	-	-	-
1991 1/2 XJ Non-Disconnect								
610402-3	Standard	4.10	706930-4X	707159X	706934X	707160X	75814-2X	75814-1X
610402-5	Standard	3.07	706930-2X	707158X	706933X	707160X	75814-2X	75814-1X
610402-7	Standard	3.55	706930-8X	707158X	706933X	707160X	75814-2X	75814-1X
1991 1/2 XJ Non-Disconnect, ABS								
610403-7	Standard	3.55	706930-8X	707158X	706933X	707160X	74286-2X	74286-1X
1991 1/2-92 1/2 XJ 4X2 (Dead Front)								
610404	-	-	-	-	-	-	-	-
1992-93 1/2 XJ 4X2 (Dead Front), ABS								
610348	-	-	-	-	-	-	-	-
1992-93 1/2 XJ Non-Disconnect, ABS								
610379-5	Standard	3.07	706930-2X	707158X	706933X	707160X	75815-2X	75815-1X
610379-7	Standard	3.55	706930-8X	707158X	706933X	707160X	75815-2X	75815-1X
1992-93 1/2 XJ Non-Disconnect								
610391-2	Standard	3.73	706930-5X	707159X	706934X	707160X	75814-2X	75814-1X
610391-3	Standard	4.10	706930-4X	707159X	706934X	707160X	75814-2X	75814-1X
610391-5	Standard	3.07	706930-2X	707158X	706933X	707160X	75814-2X	75814-1X
610391-7	Standard	3.55	706930-8X	707158X	706933X	707160X	75814-2X	75814-1X
1992-93 1/2 YJ Non-Disconnect								
610392-1	Standard	3.07	706930-2X	707158X	706007X	707160X	75814-2X	75814-1X
610392-2	Standard	3.55	706930-8X	707158X	706007X	707160X	75814-2X	75814-1X
610392-4	Standard	4.10	706930-4X	707159X	706008X	707160X	75814-2X	75814-1X
1992 1/2-93 1/2 XJ 4X2 (Dead Front)								
610316	-	-	-	-	-	-	-	-
1993-93 1/2 XJ Non-Disconnect - Live Spindle Wheel End								
610383-3	Standard	4.10	706930-4X	707159X	706934X	707160X	75814-2X	75814-1X
610383-7	Standard	3.55	706930-8X	707158X	706933X	707160X	75814-2X	75814-1X
1993-93 1/2 XJ Non-Disconnect, ABS - Live Spindle								
610413-7	Standard	3.55	706930-8X	707158X	706933X	707160X	75815-2X	75815-1X
1993-93 1/2 XJ 4X2 (Dead Front), ABS								
610416	-	-	-	-	-	-	-	-
1993-93 1/2 XJ Non-Disconnect, ABS								
610417-1	Standard	3.55	706930-8X	707158X	706933X	707160X	75815-2X	75815-1X

NOTE: All Ring & Pinion Kits with base number 706930 are reverse spiral bevel
(7) See Ring Gear & Pinion Kits in XGI Catalog for ratio & tooth combinations.
(8) See Differential Case Assy Kits in XGI Catalog for spline data & ratios.

Jeep Model 30 /181 Front Bill of Material Table

Axle			Axle Kits				Shaft & Joint Assy.	
Bill of Material	Diff. Type	Ratio	Ring Gear & Pinion Kit ⁽⁷⁾	Differential			Right Hand Shaft Assy.	Left Hand Shaft Assy.
				Case Assy. Kit ⁽⁸⁾	Case Kit	Inner Parts Kit		
1994 XJ 4X2 (Dead Front)								
610453	-	-	-	-	-	-	-	-
1994 XJ 4X2 (Dead Front), ABS								
610472	-	-	-	-	-	-	-	-
1994 XJ Non-Disconnect								
610466-2	Standard	3.73	706930-5X	707159X	706934X	707160X	75814-2X	75814-1X
610466-3	Standard	4.10	706930-4X	707159X	706934X	707160X	75814-2X	75814-1X
610466-5	Standard	3.07	706930-2X	707158X	706933X	707160X	75814-2X	75814-1X
610466-7	Standard	3.55	706930-8X	707158X	706933X	707160X	75814-2X	75814-1X
610467-5	Standard	3.07	706930-2X	707158X	706933X	707160X	75815-2X	75815-1X
610467-7	Standard	3.55	706930-8X	707158X	706933X	707160X	75815-2X	75815-1X
1994 XJ Non-Disconnect - Live Spindle Wheel End								
610468-3	Standard	4.10	706930-4X	707159X	706008X	707160X	75814-2X	75814-1X
610468-7	Standard	3.55	706930-8X	707158X	706007X	707160X	75814-2X	75814-1X
1994 XJ Non-Disconnect, ABS - Live Spindle Wheel End								
610469-7	Standard	3.55	706930-8X	707158X	706007X	707160X	75815-2X	75815-1X
1994 YJ Disconnect (Dead Front)								
610464	-	-	-	-	-	-	-	-
1994-96 YJ Non-Disconnect								
610463-2	Standard	3.55	706930-8X	707158X	706007X	707160X	75814-2X	75814-1X
610463-4	Standard	4.10	706930-4X	707159X	706008X	707160X	75814-2X	75814-1X
1994 1/2-96 XJ 4X2 (Dead Front)								
610500	-	-	-	-	-	-	-	-
1994 1/2-97 XJ 4X2 (Dead Front), ABS								
610501	-	-	-	-	-	-	-	-
1994 1/2-97 XJ Non-Disconnect								
610502-2	Standard	3.73	706930-5X	707159X	706934X	707160X	75814-2X	75814-1X
610502-3	Standard	4.10	706930-4X	707159X	706934X	707160X	75814-2X	75814-1X
610502-5	Standard	3.07	706930-2X	707158X	706933X	707160X	75814-2X	75814-1X
610502-7	Standard	3.55	706930-8X	707158X	706933X	707160X	75814-2X	75814-1X
1994 1/2-97 XJ Non-Disconnect, ABS								
610503-5	Standard	3.07	706930-2X	707158X	706933X	707160X	75815-2X	75815-1X
610503-7	Standard	3.55	706930-8X	707158X	706933X	707160X	75815-2X	75815-1X
1994 1/2-97 XJ RHD								
610504-3	Standard	4.10	706930-4X	707159X	706008X	707160X	75814-2X	75814-1X
610504-7	Standard	3.55	706930-8X	707158X	706007X	707160X	75814-2X	75814-1X
1994 1/2-97 XJ RHD, ABS								
610505-7	Standard	3.55	706930-8X	707158X	706007X	707160X	75815-2X	75815-1X
1994 1/2-97 XJ RHD, (Dead Front)								
610506	-	-	-	-	-	-	-	-
610507	-	-	-	-	-	-	-	-
1995-97 XJ Non-Disconnect, Cardan - Live Spindle Wheel End								
610367-2	Standard	3.73	706930-5X	707159X	706934X	707160X	75814-2X	75814-1X
1995-97 XJ Non-Disconnect, ABS								
610528-2	Standard	3.73	706930-5X	707159X	706934X	707160X	75815-2X	75815-1X
610558-2	Standard	3.73	706930-5X	707159X	706934X	707160X	75815-2X	75815-1X

NOTE: All Ring & Pinion Kits with base number 706930 are reverse spiral bevel
 (7) See Ring Gear & Pinion Kits in XGI Catalog for ratio & tooth combinations.
 (8) See Differential Case Assy Kits in XGI Catalog for spline data & ratios.

Jeep Model 30 /181 Front Bill of Material Table

Axle			Axle Kits				Shaft & Joint Assy.	
Bill of Material	Diff. Type	Ratio	Ring Gear & Pinion Kit ⁽⁷⁾	Differential			Right Hand Shaft Assy.	Left Hand Shaft Assy.
				Case Assy. Kit ⁽⁸⁾	Case Kit	Inner Parts Kit		
1995 1/2-97 XJ RHD								
610557-2	Standard	3.73	706930-5X	707159X	706008X	707160X	75814-2X	75814-1X
1997 XJ Non-Disconnect - Live Spindle Wheel End								
610671-2	Standard	3.73	706930-5X	707159X	706008X	707160X	75814-2X	75814-1X
610671-3	Standard	4.10	706930-4X	707159X	706008X	707160X	75814-2X	75814-1X
610671-5	Standard	3.07	706930-2X	707158X	706007X	707160X	75814-2X	75814-1X
610671-7	Standard	3.55	706930-8X	707158X	706007X	707160X	75814-2X	75814-1X
1997 1/2 XJ 4X2 (Dead Front)								
610667	-	-	-	-	-	-	-	-
610669	-	-	-	-	-	-	-	-
1997 1/2 XJ 4X2 (Dead Front), ABS								
610668	-	-	-	-	-	-	-	-
610670	-	-	-	-	-	-	-	-
1997 1/2 XJ Non-Disconnect, ABS - Live Spindle Wheel End								
610672-5	Standard	3.07	706930-2X	707158X	706007X	707160X	75815-2X	75815-1X
610672-7	Standard	3.55	706930-8X	707158X	706007X	707160X	75815-2X	75815-1X
610674-7	Standard	3.55	706930-8X	707158X	706007X	707160X	75815-2X	75815-1X
1997 1/2 XJ Non-Disconnect - Live Spindle Wheel End								
610673-3	Standard	4.10	706930-4X	707159X	706008X	707160X	75814-2X	75814-1X
610673-7	Standard	3.55	706930-8X	707158X	706007X	707160X	75814-2X	75814-1X
1997 1/2 XJ Diesel								
610675-2	Standard	3.73	706930-5X	707159X	706008X	707160X	75814-2X	75814-1X
610677-2	Standard	3.73	706930-5X	707159X	706008X	707160X	75814-2X	75814-1X
1997 1/2 XJ Diesel, ABS								
610676-2	Standard	3.73	706930-5X	707159X	706008X	707160X	75815-2X	75815-1X
610678-2	Standard	3.73	706930-5X	707159X	706008X	707160X	75815-2X	75815-1X
1998 XJ Export Non-Disconnect								
610849-1	Standard	3.07	706930-2X	707158X	706933X	707160X	75814-2X	75814-1X
610849-2	Standard	3.55	706930-8X	707158X	706933X	707160X	75814-2X	75814-1X
610849-3	Standard	4.10	706930-4X	707159X	706934X	707160X	75814-2X	75814-1X
1998 XJ Export Non-Disconnect, ABS								
610850-1	Standard	3.07	706930-2X	707158X	706933X	707160X	75815-2X	75815-1X
610850-2	Standard	3.55	706930-8X	707158X	706933X	707160X	75815-2X	75815-1X
1998 XJ Export Non-Disconnect, RH Steering								
610851-1	Standard	3.55	706930-8X	707158X	706933X	707160X	75814-2X	75814-1X
610851-2	Standard	4.10	706930-4X	707159X	706934X	707160X	75814-2X	75814-1X
1998 XJ Export Non-Disconnect, RH Steering, ABS								
610852-1	Standard	3.55	706930-8X	707158X	706933X	707160X	75815-2X	75815-1X
1998 XJ Export Non-Disconnect, Diesel, ABS								
610853-1	Standard	3.73	706930-5X	707159X	706934X	707160X	75815-2X	75815-1X
1998 XJ Export (Dead Front)								
610854	-	-	-	-	-	-	-	-
1998 XJ Export (Dead Front) ABS								
610855	-	-	-	-	-	-	-	-

NOTE: All Ring & Pinion Kits with base number 706930 are reverse spiral bevel
(7) See Ring Gear & Pinion Kits in XGI Catalog for ratio & tooth combinations.
(8) See Differential Case Assy Kits in XGI Catalog for spline data & ratios.

Jeep Model 30 /181 Front Bill of Material Table

Axle			Axle Kits				Shaft & Joint Assy.	
Bill of Material	Diff. Type	Ratio	Ring Gear & Pinion Kit ⁽⁷⁾	Differential			Right Hand Shaft Assy.	Left Hand Shaft Assy.
				Case Assy. Kit ⁽⁸⁾	Case Kit	Inner Parts Kit		
1998-98 1/2 XJ Non-Disconnect, Cardan - Live Spindle Wheel End								
610758-1	Standard	3.07	706930-2X	707158X	706007X	707160X	75814-2X	75814-1X
610758-2	Standard	3.55	706930-8X	707158X	706007X	707160X	75814-2X	75814-1X
610758-3	Standard	4.10	706930-4X	707159X	706008X	707160X	75814-2X	75814-1X
1998-98 1/2 XJ Non-Disconnect, ABS - Live Spindle								
610759-1	Standard	3.07	706930-2X	707158X	706007X	707160X	75815-2X	75815-1X
610759-2	Standard	3.55	706930-8X	707158X	706007X	707160X	75815-2X	75815-1X
610761-1	Standard	3.55	706930-8X	707158X	706007X	707160X	75815-2X	75815-1X
1998-98 1/2 XJ Non-Disconnect - Live Spindle Wheel End								
610760-1	Standard	3.55	706930-8X	707158X	706007X	707160X	75814-2X	75814-1X
610760-2	Standard	4.10	706930-4X	707159X	706008X	707160X	75814-2X	75814-1X
1998-98 1/2 XJ Diesel								
610762-1	Standard	3.73	706930-5X	707159X	706008X	707160X	75814-2X	75814-1X
610764-1	Standard	3.73	706930-5X	707159X	706008X	707160X	75814-2X	75814-1X
1998-98 1/2 XJ Diesel, ABS								
610763-1	Standard	3.73	706930-5X	707159X	706008X	707160X	75815-2X	75815-1X
610765-1	Standard	3.73	706930-5X	707159X	706008X	707160X	75815-2X	75815-1X
1998-98 1/2 XJ 4X2 (Dead Front)								
610766	-	-	-	-	-	-	-	-
610768	-	-	-	-	-	-	-	-
1998-98 1/2 XJ 4X2 (Dead Front), ABS								
610767	-	-	-	-	-	-	-	-
610769	-	-	-	-	-	-	-	-

NOTE: All Ring & Pinion Kits with base number 706930 are reverse spiral bevel
 (7) See Ring Gear & Pinion Kits in XGI Catalog for ratio & tooth combinations.
 (8) See Differential Case Assy Kits in XGI Catalog for spline data & ratios.

Jeep Model 30 /181 Front Variable Parts Listing

Kits & Parts - Use With All Applications							
Description & Item Number (Refer to "Exploded View" at the front of this section)			Bills of Material				
			603732	610053 610086 610136 610154 610156 610164	610183	610206 610221	610222
1	Seal – Pinion Oil	10	39118	39118	39118	39118	39118
2	End Yoke or Assembly (inc 12)	11	2-4-8091-1X	2-4-8091-1X	2-4-6771-1X	2-4-8091-1X	2-4-6771-1X
3	Slinger – End Yoke	12	41498	41498	41498	41498	41498
4	KIT – Carrier Cover	-	706348X	706348X	706943X	706943X	706943X
5	Carrier Cover	15	36538	36538	40869	40869	40869
6	Gasket/RTV Silicone Sealant	16	34684	34684	38615	38615	38615
7	Plug – Carrier Cover	17	36472	36472	36924	36924	36924
8	Gear – Differential (std)	26	33213	33213	620486	620486	620486
9	Thrustwasher – Differential Gear (std)	28	34095	34095	40027	40027	40027
10	KIT – Right Knuckle Assembly	-	706535X	700074	—	—	—
11	KIT – Left Knuckle Assembly	-	706536X	700075	—	—	—
12	KIT – Socket Assembly	-	706116X	706116X	706944X	706944X	706944X
13	Nut – Slotted	32	35416	35416	43682	43682	44101
14	Adjusting Split Ring	34	35417	35417	40586	40586	40586
15	Socket Assembly	35	40112	40112	40583	40583	40583
16	Nut – Hex Jam / Slotted	36	35566	35566	40584	40584	40584
17	Socket Assembly	37	40113	40113	40916	40916	40916
18	Snap Ring	38	35928	35928	—	—	—
19	Bolt – Knuckle	39	36326-3	36326-1	41027	41027	41027
20	Right Knuckle	40	37639	41535	40707	40707	40707
21	Left Knuckle	41	37640	41536	40579	40579	40579
22	Slinger – Spindle Yoke (Inner)	46	35168	35168	46849	46849	46849
23	Slinger – Spindle Yoke (Outer)	47	36364	36364	40589	40589	40589
24	KIT – Spindle Seal & Bearing	-	706527X	706527X	—	—	—
25	KIT – Spindle	-	706537X	706537X	—	—	—
26	Oil Seal	48	36361	36361	—	—	—
27	Oil Seal (block vee)	49	38128	38128	—	—	—
28	Spacer – Wheel Bearing Spindle	50	38106	38106	—	—	—
29	Needle Bearing Assembly	51	550759	550759	—	—	—
30	Spindle – Wheel Bearing	52	38148	38148	—	—	—
31	KIT – Inner Wheel Bearing	55	706578X	706578X	—	—	—
32	KIT – Outer Wheel Bearing	57	706111X	706111X	—	—	—
33	Lockwasher – Wheel Bearing	58	17015	17015	—	—	—
34	Nut – Wheel Bearing	59	17016	17016	—	—	—
35	Lockwasher – Wheel Bearing Nut	60	17017	17017	—	—	—
36	Gasket – Drive Flange	61	18188	18188	—	—	—
37	Flange – Axle Drive	62	36436	36436	—	—	—
38	Snap Ring	63	18270	18270	—	—	—
39	Hub Cap	64	32001	32001	—	—	—
40	Lockwasher	66	501209-3	501209-3	—	—	—
41	Hub Assembly	67	—	—	40592	40592	40592
42	Tone Ring (ABS)/Slinger	72	—	—	—	—	—
43	Spring – Wave Washer	73	—	—	—	—	—

(See next page for additional bills of material)

Jeep Model 30 /181 Front Variable Parts Listing

Kits & Parts - Use With All Applications							
Description & Item Number (Refer to "Exploded View" at the front of this section)			Bills of Material				
			610234 610237	610244	610256	610269	610280
1	Seal – Pinion Oil	10	39118	39118	39118	39118	39118
2	End Yoke or Assembly (inc 12)	11	—	2-4-8091-1X	—	2-4-8091-1X	2-4-6561-1
3	Slinger – End Yoke	12	—	41498	—	41498	—
4	KIT – Carrier Cover	-	—	707049X	—	706943X	706943X
5	Carrier Cover	15	—	36538	—	40869	40869
6	Gasket/RTV Silicone Sealant	16	—	38615	—	38615	39615
7	Plug – Carrier Cover	17	—	36918	—	36924	36924
8	Gear – Differential (std)	26	—	33213	—	620486	620486
9	Thrustwasher – Diff Gear (std)	28	—	34095	—	40027	40027
10	KIT – Right Knuckle Assembly	-	—	700074	—	—	—
11	KIT – Left Knuckle Assembly	-	—	700075	—	—	—
12	KIT – Socket Assembly	-	706944X	706116X	706944X	706944X	706944X
13	Nut – Slotted	32	43682	35416	43682	43682	43682
14	Adjusting Split Ring	34	40586	35417	40586	40586	40586
15	Socket Assembly	35	40583	40112	40583	40583	40583
16	Nut – Hex Jam / Slotted	36	40584	35566	40584	40584	40584
17	Socket Assembly	37	40916	40113	40916	40916	40916
18	Snap Ring	38	—	35928	—	—	—
19	Bolt – Knuckle	39	41027	36326-1	—	41027	41027
20	Right Knuckle	40	40707	41535	—	40707	40707
21	Left Knuckle	41	40579	41536	—	40579	40579
22	Slinger – Spindle Yoke (Inner)	46	—	35168	—	46849	46849
23	Slinger – Spindle Yoke (Outer)	47	—	36364	—	40589	40589
24	KIT – Spindle Seal & Bearing	-	—	706527X	—	—	—
25	KIT – Spindle	-	—	706537X	—	—	—
26	Oil Seal	48	—	36361	—	—	—
27	Oil Seal (block vee)	49	—	38128	—	—	—
28	Spacer – Wheel Bearing Spindle	50	—	38106	—	—	—
29	Needle Bearing Assembly	51	—	550759	—	—	—
30	Spindle – Wheel Bearing	52	—	38148	—	—	—
31	KIT – Inner Wheel Bearing	55	—	706578X	—	—	—
32	KIT – Outer Wheel Bearing	57	—	706111X	—	—	—
33	Lockwasher – Wheel Bearing	58	—	17015	—	—	—
34	Nut – Wheel Bearing	59	—	17016	—	—	—
35	Lockwasher – Wheel Bearing Nut	60	—	17017	—	—	—
36	Gasket – Drive Flange	61	—	18188	—	—	—
37	Flange – Axle Drive	62	—	36436	—	—	—
38	Snap Ring	63	—	18270	—	—	—
39	Hub Cap	64	—	32001	—	—	—
40	Lockwasher	66	—	501209-3	—	—	—
41	Hub Assembly	67	40592	—	—	40592	40592
42	Tone Ring (ABS)/Slinger	72	—	—	—	—	—
43	Spring – Wave Washer	73	—	—	—	—	—

(See next page for additional bills of material)

Jeep Model 30 /181 Front Variable Parts Listing

Kits & Parts - Use With All Applications							
	Description & Item Number (Refer to "Exploded View" at the front of this section)		Bills of Material				
			610282	610294	610316	610318 610320	610322 610324
1	Seal – Pinion Oil	10	39118	39118	39118	39118	39118
2	End Yoke or Assembly (inc 12)	11	2-4-8091-1X	2-4-6561-1	—	2-4-6561-1	2-4-6561-1
3	Slinger – End Yoke	12	41498	—	—	—	—
4	KIT – Carrier Cover	-	706943X	706943X	—	707180X	707180X
5	Carrier Cover	15	40869	40869	—	40869	40869
6	Gasket/RTV Silicone Sealant	16	38615	38615	—	38615	38615
7	Plug – Carrier Cover	17	36924	36924	—	43180	43180
8	Gear – Differential (std)	26	620486	620486	—	33213	620486
9	Thrustwasher – Diff Gear (std)	28	40027	40027	—	40027	40027
10	KIT – Right Knuckle Assembly	-	—	—	74507X	74231X	—
11	KIT – Left Knuckle Assembly	-	—	—	74508X	74232X	—
12	KIT – Socket Assembly	-	706944X	706944X	706944X	706944X	706944X
13	Nut – Slotted	32	43682	43682	43682	43682	43682
14	Adjusting Split Ring	34	40586	40586	40586	40586	40586
15	Socket Assembly	35	40583	40583	40583	40583	40583
16	Nut – Hex Jam / Slotted	36	40584	40584	40584	40584	40584
17	Socket Assembly	37	40916	40916	40916	40916	40916
18	Snap Ring	38	—	—	—	—	—
19	Bolt – Knuckle	39	41027	41027	41027	41027	41027
20	Right Knuckle	40	40707	42800	44322	43351	40707
21	Left Knuckle	41	40579	42801	44323	43352	40579
22	Slinger – Spindle Yoke (Inner)	46	46849	701113X	—	46849	46849
23	Slinger – Spindle Yoke (Outer)	47	40589	—	40589	40589	40589
24	KIT – Spindle Seal & Bearing	-	—	—	—	—	—
25	KIT – Spindle	-	—	—	—	—	—
26	Oil Seal	48	—	—	—	—	—
27	Oil Seal (block vee)	49	—	—	—	—	—
28	Spacer – Wheel Bearing Spindle	50	—	—	—	—	—
29	Needle Bearing Assembly	51	—	—	—	—	—
30	Spindle – Wheel Bearing	52	—	—	—	—	—
31	KIT – Inner Wheel Bearing	55	—	—	—	—	—
32	KIT – Outer Wheel Bearing	57	—	—	—	—	—
33	Lockwasher – Wheel Bearing	58	—	—	—	—	—
34	Nut – Wheel Bearing	59	—	—	—	—	—
35	Lockwasher – Wheel Bearing Nut	60	—	—	—	—	—
36	Gasket – Drive Flange	61	—	—	—	—	—
37	Flange – Axle Drive	62	—	—	—	—	—
38	Snap Ring	63	—	—	—	—	—
39	Hub Cap	64	—	—	—	—	—
40	Lockwasher	66	—	—	—	—	—
41	Hub Assembly	67	40592	40592	43355	43355	40592
42	Tone Ring (ABS)/Slinger	72	—	42805	—	—	—
43	Spring – Wave Washer	73	—	—	45749	—	—

(See next page for additional bills of material)

Jeep Model 30 /181 Front Variable Parts Listing

Kits & Parts - Use With All Applications							
Description & Item Number (Refer to "Exploded View" at the front of this section)			Bills of Material				
			610327	610334	610336	610337	610340
1	Seal – Pinion Oil	10	39118	39118	39118	39118	39118
2	End Yoke or Assembly (inc 12)	11	2-4-6561-1	2-4-6561-1	2-4-6561-1	2-4-6561-1	2-4-6561-1
3	Slinger – End Yoke	12	—	—	—	—	—
4	KIT – Carrier Cover	-	707180X	706943X	707180X	707180X	707180X
5	Carrier Cover	15	40869	40869	40869	40869	40869
6	Gasket/RTV Silicone Sealant	16	38615	38615	38615	38615	38615
7	Plug – Carrier Cover	17	43180	43180	43180	43180	43180
8	Gear – Differential (std)	26	620486	620486	33213	620486	33213
9	Thrustwasher – Diff Gear (std)	28	40027	40027	40027	40027	40027
10	KIT – Right Knuckle Assembly	-	—	—	74233X	—	—
11	KIT – Left Knuckle Assembly	-	—	—	74234X	—	—
12	KIT – Socket Assembly	-	706944X	706944X	706944X	706944X	706944X
13	Nut – Slotted	32	43682	43682	43682	43682	43682
14	Adjusting Split Ring	34	40586	40586	40586	40586	40586
15	Socket Assembly	35	40583	40583	40583	40583	40583
16	Nut – Hex Jam / Slotted	36	40584	40584	40584	40584	40584
17	Socket Assembly	37	40916	40916	40916	40916	40916
18	Snap Ring	38	—	—	—	—	—
19	Bolt – Knuckle	39	41027	41027	41027	41027	41027
20	Right Knuckle	40	42800	40707	43391	40707	43351
21	Left Knuckle	41	42801	40579	43392	40579	43352
22	Slinger – Spindle Yoke (Inner)	46	701113X	46849	701113X	46849	46849
23	Slinger – Spindle Yoke (Outer)	47	—	40589	—	40589	40589
24	KIT – Spindle Seal & Bearing	-	—	—	—	—	—
25	KIT – Spindle	-	—	—	—	—	—
26	Oil Seal	48	—	—	—	—	—
27	Oil Seal (block vee)	49	—	—	—	—	—
28	Spacer – Wheel Bearing Spindle	50	—	—	—	—	—
29	Needle Bearing Assembly	51	—	—	—	—	—
30	Spindle – Wheel Bearing	52	—	—	—	—	—
31	KIT – Inner Wheel Bearing	55	—	—	—	—	—
32	KIT – Outer Wheel Bearing	57	—	—	—	—	—
33	Lockwasher – Wheel Bearing	58	—	—	—	—	—
34	Nut – Wheel Bearing	59	—	—	—	—	—
35	Lockwasher – Wheel Bearing Nut	60	—	—	—	—	—
36	Gasket – Drive Flange	61	—	—	—	—	—
37	Flange – Axle Drive	62	—	—	—	—	—
38	Snap Ring	63	—	—	—	—	—
39	Hub Cap	64	—	—	—	—	—
40	Lockwasher	66	—	—	—	—	—
41	Hub Assembly	67	40592	40592	43355	40592	43355
42	Tone Ring (ABS)/Slinger	72	42805	—	42805	—	—
43	Spring – Wave Washer	73	—	—	—	—	—

(See next page for additional bills of material)

Jeep Model 30 /181 Front Variable Parts Listing

Kits & Parts - Use With All Applications							
Description & Item Number (Refer to "Exploded View" at the front of this section)			Bills of Material				
			610348	610351	610367	610373	610375
1	Seal – Pinion Oil	10	39118	39118	39118	39118	39118
2	End Yoke or Assembly (inc 12)	11	—	—	2-4-6561-1	2-4-6561-1	—
3	Slinger – End Yoke	12	—	—	—	—	—
4	KIT – Carrier Cover	-	—	—	707180X	707180X	—
5	Carrier Cover	15	—	—	40869	40869	—
6	Gasket/RTV Silicone Sealant	16	—	—	38615	38615	—
7	Plug – Carrier Cover	17	—	—	43180	43180	—
8	Gear – Differential (std)	26	—	—	33213	33213	—
9	Thrustwasher – Diff Gear (std)	28	—	—	40027	40027	—
10	KIT – Right Knuckle Assembly	-	—	—	74507X	74231X	—
11	KIT – Left Knuckle Assembly	-	—	—	74508X	74232X	—
12	KIT – Socket Assembly	-	706944X	706944X	706944X	706944X	706944X
13	Nut – Slotted	32	43682	43682	43682	43682	43682
14	Adjusting Split Ring	34	40586	40586	40586	40586	40586
15	Socket Assembly	35	40583	40583	40583	40583	40583
16	Nut – Hex Jam / Slotted	36	40584	40584	40584	40584	40584
17	Socket Assembly	37	40916	40916	40916	40916	40916
18	Snap Ring	38	—	—	—	—	—
19	Bolt – Knuckle	39	41027	—	41027	41027	—
20	Right Knuckle	40	44181	—	44322	43351	—
21	Left Knuckle	41	44182	—	44323	43352	—
22	Slinger – Spindle Yoke (Inner)	46	—	—	46849	46849	—
23	Slinger – Spindle Yoke (Outer)	47	—	—	40589	40589	—
24	KIT – Spindle Seal & Bearing	-	—	—	—	—	—
25	KIT – Spindle	-	—	—	—	—	—
26	Oil Seal	48	—	—	—	—	—
27	Oil Seal (block vee)	49	—	—	—	—	—
28	Spacer – Wheel Bearing Spindle	50	—	—	—	—	—
29	Needle Bearing Assembly	51	—	—	—	—	—
30	Spindle – Wheel Bearing	52	—	—	—	—	—
31	KIT – Inner Wheel Bearing	55	—	—	—	—	—
32	KIT – Outer Wheel Bearing	57	—	—	—	—	—
33	Lockwasher – Wheel Bearing	58	—	—	—	—	—
34	Nut – Wheel Bearing	59	—	—	—	—	—
35	Lockwasher – Wheel Bearing Nut	60	—	—	—	—	—
36	Gasket – Drive Flange	61	—	—	—	—	—
37	Flange – Axle Drive	62	—	—	—	—	—
38	Snap Ring	63	—	—	—	—	—
39	Hub Cap	64	—	—	—	—	—
40	Lockwasher	66	—	—	—	—	—
41	Hub Assembly	67	43355	—	43355	43355	—
42	Tone Ring (ABS)/Slinger	72	44646	—	—	—	—
43	Spring – Wave Washer	73	45749	—	45749	—	45749

(See next page for additional bills of material)

Jeep Model 30 /181 Front Variable Parts Listing

Kits & Parts - Use With All Applications							
Description & Item Number (Refer to "Exploded View" at the front of this section)			Bills of Material				
			610379	610383	610391	610392	610402
1	Seal – Pinion Oil	10	39118	44895	39118	39118	39118
2	End Yoke or Assembly (inc 12)	11	2-4-6561-1	2-4-6561-1	2-4-6561-1	2-4-6561-1	2-4-6561-1
3	Slinger – End Yoke	12	—	—	—	—	—
4	KIT – Carrier Cover	-	707180X	707180X	707180X	707180X	707180X
5	Carrier Cover	15	40869	40869	40869	40869	40869
6	Gasket/RTV Silicone Sealant	16	38615	38615	38615	38615	38615
7	Plug – Carrier Cover	17	43180	43180	43180	43180	43180
8	Gear – Differential (std)	26	33213	33213	33213	33213	33213
9	Thrustwasher – Diff Gear (std)	28	40027	40027	40027	40027	40027
10	KIT – Right Knuckle Assembly	-	74386X	74507X	74507X	74507X	74507X
11	KIT – Left Knuckle Assembly	-	74387X	74508X	74508X	74508X	74508X
12	KIT – Socket Assembly	-	706944X	706944X	706944X	706944X	706944X
13	Nut – Slotted	32	43682	43682	43682	43682	43682
14	Adjusting Split Ring	34	40586	40586	40586	40586	40586
15	Socket Assembly	35	40583	40583	40583	40583	40583
16	Nut – Hex Jam / Slotted	36	40584	40584	40584	40584	40584
17	Socket Assembly	37	40916	40916	40916	40916	40916
18	Snap Ring	38	—	—	—	—	—
19	Bolt – Knuckle	39	41027	41027	41027	41027	41027
20	Right Knuckle	40	44181	44322	44322	44322	44322
21	Left Knuckle	41	44182	44323	44323	44323	44323
22	Slinger – Spindle Yoke (Inner)	46	46849	46849	46849	46849	46849
23	Slinger – Spindle Yoke (Outer)	47	—	46988	40589	40589	40589
24	KIT – Spindle Seal & Bearing	-	—	—	—	—	—
25	KIT – Spindle	-	—	—	—	—	—
26	Oil Seal	48	—	—	—	—	—
27	Oil Seal (block vee)	49	—	—	—	—	—
28	Spacer – Wheel Bearing Spindle	50	—	—	—	—	—
29	Needle Bearing Assembly	51	—	—	—	—	—
30	Spindle – Wheel Bearing	52	—	—	—	—	—
31	KIT – Inner Wheel Bearing	55	—	—	—	—	—
32	KIT – Outer Wheel Bearing	57	—	—	—	—	—
33	Lockwasher – Wheel Bearing	58	—	—	—	—	—
34	Nut – Wheel Bearing	59	—	—	—	—	—
35	Lockwasher – Wheel Bearing Nut	60	—	—	—	—	—
36	Gasket – Drive Flange	61	—	—	—	—	—
37	Flange – Axle Drive	62	—	—	—	—	—
38	Snap Ring	63	—	—	—	—	—
39	Hub Cap	64	—	—	—	—	—
40	Lockwasher	66	—	—	—	—	—
41	Hub Assembly	67	43355	43355	43355	43355	43355
42	Tone Ring (ABS)/Slinger	72	44646	—	—	—	—
43	Spring – Wave Washer	73	—	45749	—	45749	—

(See next page for additional bills of material)

Jeep Model 30 /181 Front Variable Parts Listing

Kits & Parts - Use With All Applications							
Description & Item Number (Refer to "Exploded View" at the front of this section)			Bills of Material				
			610403	610404	610413	610416	610417
1	Seal – Pinion Oil	10	39118	39118	44895	39118	39118
2	End Yoke or Assembly (inc 12)	11	2-4-6561-1	—	2-4-6561-1	—	2-4-6561-1
3	Slinger – End Yoke	12	—	—	—	—	—
4	KIT – Carrier Cover	-	707180X	—	707180X	—	707180X
5	Carrier Cover	15	40869	—	40869	—	40869
6	Gasket/RTV Silicone Sealant	16	38615	—	38615	—	38615
7	Plug – Carrier Cover	17	43180	—	43180	—	43180
8	Gear – Differential (std)	26	33213	—	33213	—	33213
9	Thrustwasher – Diff Gear (std)	28	40027	—	40027	—	40027
10	KIT – Right Knuckle Assembly	-	74233X	—	74386X	74386X	74386X
11	KIT – Left Knuckle Assembly	-	74234X	—	74387X	74387X	74387X
12	KIT – Socket Assembly	-	706944X	706944X	706944X	706944X	706944X
13	Nut – Slotted	32	43682	43682	43682	43682	43682
14	Adjusting Split Ring	34	40586	40586	40586	40586	40586
15	Socket Assembly	35	40583	40583	40583	40583	40583
16	Nut – Hex Jam / Slotted	36	40584	40584	40584	40584	40584
17	Socket Assembly	37	40916	40916	40916	40916	40916
18	Snap Ring	38	—	—	—	—	—
19	Bolt – Knuckle	39	41027	—	41027	41027	41027
20	Right Knuckle	40	43391	—	44181	44181	44181
21	Left Knuckle	41	43392	—	44182	44182	44182
22	Slinger – Spindle Yoke (Inner)	46	701113X	—	46849	—	46849
23	Slinger – Spindle Yoke (Outer)	47	—	—	—	—	—
24	KIT – Spindle Seal & Bearing	-	—	—	—	—	—
25	KIT – Spindle	-	—	—	—	—	—
26	Oil Seal	48	—	—	—	—	—
27	Oil Seal (block vee)	49	—	—	—	—	—
28	Spacer – Wheel Bearing Spindle	50	—	—	—	—	—
29	Needle Bearing Assembly	51	—	—	—	—	—
30	Spindle – Wheel Bearing	52	—	—	—	—	—
31	KIT – Inner Wheel Bearing	55	—	—	—	—	—
32	KIT – Outer Wheel Bearing	57	—	—	—	—	—
33	Lockwasher – Wheel Bearing	58	—	—	—	—	—
34	Nut – Wheel Bearing	59	—	—	—	—	—
35	Lockwasher – Wheel Bearing Nut	60	—	—	—	—	—
36	Gasket – Drive Flange	61	—	—	—	—	—
37	Flange – Axle Drive	62	—	—	—	—	—
38	Snap Ring	63	—	—	—	—	—
39	Hub Cap	64	—	—	—	—	—
40	Lockwasher	66	—	—	—	—	—
41	Hub Assembly	67	—	—	43355	43355	43355
42	Tone Ring (ABS)/Slinger	72	42805	—	44646	44646	44646
43	Spring – Wave Washer	73	—	—	45749	45749	45749

(See next page for additional bills of material)

Jeep Model 30 /181 Front Variable Parts Listing

Kits & Parts - Use With All Applications							
Description & Item Number (Refer to "Exploded View" at the front of this section)			Bills of Material				
			610453	610463	610464	610466	610467
1	Seal – Pinion Oil	10	—	39118	39118	39118	39118
2	End Yoke or Assembly (inc 12)	11	—	2-4-6561-1	—	2-4-6561-1	2-4-6561-1
3	Slinger – End Yoke	12	—	—	—	—	—
4	KIT – Carrier Cover	-	—	707180X	—	707180X	707180X
5	Carrier Cover	15	—	40869	—	40869	40869
6	Gasket/RTV Silicone Sealant	16	—	38615	—	38615	38615
7	Plug – Carrier Cover	17	—	43180	—	43180	43180
8	Gear – Differential (std)	26	—	33213	—	33213	33213
9	Thrustwasher – Diff Gear (std)	28	—	40027	—	40027	40027
10	KIT – Right Knuckle Assembly	-	74507X	74507X	74507X	74507X	74386X
11	KIT – Left Knuckle Assembly	-	74508X	74508X	74508X	74508X	74387X
12	KIT – Socket Assembly	-	706944X	706944X	706944X	706944X	706944X
13	Nut – Slotted	32	43682	43682	43682	43682	43682
14	Adjusting Split Ring	34	40586	40586	40586	40586	40586
15	Socket Assembly	35	40583	40583	40583	40583	40583
16	Nut – Hex Jam / Slotted	36	40584	40584	40584	40584	40584
17	Socket Assembly	37	40916	40916	40916	40916	40916
18	Snap Ring	38	—	—	—	—	—
19	Bolt – Knuckle	39	41027	41027	41027	41027	41027
20	Right Knuckle	40	44322	44322	44322	44322	44181
21	Left Knuckle	41	44323	44323	44323	44323	44182
22	Slinger – Spindle Yoke (Inner)	46	—	46849	—	46849	46849
23	Slinger – Spindle Yoke (Outer)	47	40589	40589	40589	40589	—
24	KIT – Spindle Seal & Bearing	-	—	—	—	—	—
25	KIT – Spindle	-	—	—	—	—	—
26	Oil Seal	48	—	—	—	—	—
27	Oil Seal (block vee)	49	—	—	—	—	—
28	Spacer – Wheel Bearing Spindle	50	—	—	—	—	—
29	Needle Bearing Assembly	51	—	—	—	—	—
30	Spindle – Wheel Bearing	52	—	—	—	—	—
31	KIT – Inner Wheel Bearing	55	—	—	—	—	—
32	KIT – Outer Wheel Bearing	57	—	—	—	—	—
33	Lockwasher – Wheel Bearing	58	—	—	—	—	—
34	Nut – Wheel Bearing	59	—	—	—	—	—
35	Lockwasher – Wheel Bearing Nut	60	—	—	—	—	—
36	Gasket – Drive Flange	61	—	—	—	—	—
37	Flange – Axle Drive	62	—	—	—	—	—
38	Snap Ring	63	—	—	—	—	—
39	Hub Cap	64	—	—	—	—	—
40	Lockwasher	66	—	—	—	—	—
41	Hub Assembly	67	43355	43355	43355	43355	43355
42	Tone Ring (ABS)/Slinger	72	—	—	—	—	—
43	Spring – Wave Washer	73	45749	45749	45749	45749	45749

(See next page for additional bills of material)

Jeep Model 30 /181 Front Variable Parts Listing

Kits & Parts - Use With All Applications							
Description & Item Number (Refer to "Exploded View" at the front of this section)			Bills of Material				
			610468	610469	610472	610500	610501
1	Seal – Pinion Oil	10	44895	44895	—	39118	39118
2	End Yoke or Assembly (inc 12)	11	2-4-6561-1	2-4-6561-1	—	—	—
3	Slinger – End Yoke	12	—	—	—	—	—
4	KIT – Carrier Cover	-	707180X	707180X	—	—	—
5	Carrier Cover	15	40869	40869	—	—	—
6	Gasket/RTV Silicone Sealant	16	38615	38615	—	—	—
7	Plug – Carrier Cover	17	43180	43180	—	—	—
8	Gear – Differential (std)	26	33213	33213	—	—	—
9	Thrustwasher – Diff Gear (std)	28	40027	40027	—	—	—
10	KIT – Right Knuckle Assembly	-	74507X	74386X	74386X	74507X	74386X
11	KIT – Left Knuckle Assembly	-	74508X	74387X	74387X	74508X	74387X
12	KIT – Socket Assembly	-	706944X	706944X	706944X	706944X	706944X
13	Nut – Slotted	32	43682	43682	43682	43682	43682
14	Adjusting Split Ring	34	40586	40586	40586	40586	40586
15	Socket Assembly	35	40583	40583	40583	40583	40583
16	Nut – Hex Jam / Slotted	36	40584	40584	40584	40584	40584
17	Socket Assembly	37	40916	40916	40916	40916	40916
18	Snap Ring	38	—	—	—	—	—
19	Bolt – Knuckle	39	41027	41027	41027	41027	41027
20	Right Knuckle	40	44322	44181	44181	44322	44181
21	Left Knuckle	41	44323	44182	44182	44323	44182
22	Slinger – Spindle Yoke (Inner)	46	46849	46849	—	—	—
23	Slinger – Spindle Yoke (Outer)	47	46988	—	—	40589	—
24	KIT – Spindle Seal & Bearing	-	—	—	—	—	—
25	KIT – Spindle	-	—	—	—	—	—
26	Oil Seal	48	—	—	—	—	—
27	Oil Seal (block vee)	49	—	—	—	—	—
28	Spacer – Wheel Bearing Spindle	50	—	—	—	—	—
29	Needle Bearing Assembly	51	—	—	—	—	—
30	Spindle – Wheel Bearing	52	—	—	—	—	—
31	KIT – Inner Wheel Bearing	55	—	—	—	—	—
32	KIT – Outer Wheel Bearing	57	—	—	—	—	—
33	Lockwasher – Wheel Bearing	58	—	—	—	—	—
34	Nut – Wheel Bearing	59	—	—	—	—	—
35	Lockwasher – Wheel Bearing Nut	60	—	—	—	—	—
36	Gasket – Drive Flange	61	—	—	—	—	—
37	Flange – Axle Drive	62	—	—	—	—	—
38	Snap Ring	63	—	—	—	—	—
39	Hub Cap	64	—	—	—	—	—
40	Lockwasher	66	—	—	—	—	—
41	Hub Assembly	67	43355	43355	43355	43355	43355
42	Tone Ring (ABS)/Slinger	72	—	44646	44646	—	44646
43	Spring – Wave Washer	73	45749	45749	45749	45749	45749

(See next page for additional bills of material)

Jeep Model 30 /181 Front Variable Parts Listing

Kits & Parts - Use With All Applications							
Description & Item Number (Refer to "Exploded View" at the front of this section)			Bills of Material				
			610502	610503	610504	610505	610506
1	Seal – Pinion Oil	10	39118	39118	39118	39118	39118
2	End Yoke or Assembly (inc 12)	11	2-4-6561-1	2-4-6561-1	2-4-6561-1	2-4-6561-1	—
3	Slinger – End Yoke	12	—	—	—	—	—
4	KIT – Carrier Cover	-	707180X	707180X	707180X	707180X	—
5	Carrier Cover	15	40869	40869	40689	40869	—
6	Gasket/RTV Silicone Sealant	16	38615	38615	38615	38615	—
7	Plug – Carrier Cover	17	43180	43180	43180	43180	—
8	Gear – Differential (std)	26	33213	33213	33213	33213	—
9	Thrustwasher – Diff Gear (std)	28	40027	40027	40027	40027	—
10	KIT – Right Knuckle Assembly	-	74507X	74386X	74507X	74386X	74507X
11	KIT – Left Knuckle Assembly	-	74508X	74387X	74508X	74387X	74508X
12	KIT – Socket Assembly	-	706944X	706944X	706944X	706944X	706944X
13	Nut – Slotted	32	43682	43682	43682	43682	43682
14	Adjusting Split Ring	34	40586	40586	40586	40586	40586
15	Socket Assembly	35	40583	40583	40583	40583	40583
16	Nut – Hex Jam / Slotted	36	40584	40584	40584	40584	40584
17	Socket Assembly	37	40916	40916	40916	40916	40916
18	Snap Ring	38	—	—	—	—	—
19	Bolt – Knuckle	39	40127	41027	41027	41027	41027
20	Right Knuckle	40	44322	44181	44322	44181	44322
21	Left Knuckle	41	44323	44182	44323	44182	44323
22	Slinger – Spindle Yoke (Inner)	46	46849	46849	46849	46849	—
23	Slinger – Spindle Yoke (Outer)	47	40589	—	40589	—	—
24	KIT – Spindle Seal & Bearing	-	—	—	—	—	—
25	KIT – Spindle	-	—	—	—	—	—
26	Oil Seal	48	—	—	—	—	—
27	Oil Seal (block vee)	49	—	—	—	—	—
28	Spacer – Wheel Bearing Spindle	50	—	—	—	—	—
29	Needle Bearing Assembly	51	—	—	—	—	—
30	Spindle – Wheel Bearing	52	—	—	—	—	—
31	KIT – Inner Wheel Bearing	55	—	—	—	—	—
32	KIT – Outer Wheel Bearing	57	—	—	—	—	—
33	Lockwasher – Wheel Bearing	58	—	—	—	—	—
34	Nut – Wheel Bearing	59	—	—	—	—	—
35	Lockwasher – Wheel Bearing Nut	60	—	—	—	—	—
36	Gasket – Drive Flange	61	—	—	—	—	—
37	Flange – Axle Drive	62	—	—	—	—	—
38	Snap Ring	63	—	—	—	—	—
39	Hub Cap	64	—	—	—	—	—
40	Lockwasher	66	—	—	—	—	—
41	Hub Assembly	67	43355	43355	43355	43355	43355
42	Tone Ring (ABS)/Slinger	72	—	44646	—	44646	—
43	Spring – Wave Washer	73	45749	45749	45749	45749	45749

(See next page for additional bills of material)

Jeep Model 30 /181 Front Variable Parts Listing

Kits & Parts - Use With All Applications							
Description & Item Number (Refer to "Exploded View" at the front of this section)			Bills of Material				
			610507	610528	610557	610558	610667
1	Seal – Pinion Oil	10	39118	39118	39118	39118	—
2	End Yoke or Assembly (inc 12)	11	—	2-4-6561-1	2-4-6561-1	2-4-6561-1	—
3	Slinger – End Yoke	12	—	—	—	—	—
4	KIT – Carrier Cover	-	—	707180X	707180X	707180X	—
5	Carrier Cover	15	—	40869	40869	40869	—
6	Gasket/RTV Silicone Sealant	16	—	38615	38615	38615	—
7	Plug – Carrier Cover	17	—	43180	43180	43180	—
8	Gear – Differential (std)	26	—	33213	33213	33213	—
9	Thrustwasher – Diff Gear (std)	28	—	40027	40027	40027	—
10	KIT – Right Knuckle Assembly	-	74386X	74386X	74507X	74386X	74507X
11	KIT – Left Knuckle Assembly	-	74387X	74387X	74508X	74387X	74508X
12	KIT – Socket Assembly	-	706944X	706944X	706944X	706944X	706944X
13	Nut – Slotted	32	43682	43682	43682	43682	43682
14	Adjusting Split Ring	34	40586	40586	40586	40586	40586
15	Socket Assembly	35	40583	40583	40583	40583	40583
16	Nut – Hex Jam / Slotted	36	40584	40584	40584	40584	40584
17	Socket Assembly	37	40916	40916	40916	40916	40916
18	Snap Ring	38	—	—	—	—	—
19	Bolt – Knuckle	39	41027	41027	41027	41027	41027
20	Right Knuckle	40	44181	44181	44322	44181	44322
21	Left Knuckle	41	44182	44182	44323	44182	44323
22	Slinger – Spindle Yoke (Inner)	46	—	46849	46849	46849	—
23	Slinger – Spindle Yoke (Outer)	47	—	—	40589	—	46988
24	KIT – Spindle Seal & Bearing	-	—	—	—	—	—
25	KIT – Spindle	-	—	—	—	—	—
26	Oil Seal	48	—	—	—	—	—
27	Oil Seal (block vee)	49	—	—	—	—	—
28	Spacer – Wheel Bearing Spindle	50	—	—	—	—	—
29	Needle Bearing Assembly	51	—	—	—	—	—
30	Spindle – Wheel Bearing	52	—	—	—	—	—
31	KIT – Inner Wheel Bearing	55	—	—	—	—	—
32	KIT – Outer Wheel Bearing	57	—	—	—	—	—
33	Lockwasher – Wheel Bearing	58	—	—	—	—	—
34	Nut – Wheel Bearing	59	—	—	—	—	—
35	Lockwasher – Wheel Bearing Nut	60	—	—	—	—	—
36	Gasket – Drive Flange	61	—	—	—	—	—
37	Flange – Axle Drive	62	—	—	—	—	—
38	Snap Ring	63	—	—	—	—	—
39	Hub Cap	64	—	—	—	—	—
40	Lockwasher	66	—	—	—	—	—
41	Hub Assembly	67	43355	43355	43355	43355	43355
42	Tone Ring (ABS)/Slinger	72	—	44646	—	44646	—
43	Spring – Wave Washer	73	45749	45749	45749	45749	45749

(See next page for additional bills of material)

Jeep Model 30 /181 Front Variable Parts Listing

Kits & Parts - Use With All Applications							
Description & Item Number (Refer to "Exploded View" at the front of this section)			Bills of Material				
			610668	610669	610670	610671	610672
1	Seal – Pinion Oil	10	—	—	—	44895	44895
2	End Yoke or Assembly (inc 12)	11	—	—	—	2-4-6561-1	2-4-6561-1
3	Slinger – End Yoke	12	—	—	—	—	—
4	KIT – Carrier Cover	-	—	—	—	707180X	707180X
5	Carrier Cover	15	—	—	—	40869	40869
6	Gasket/RTV Silicone Sealant	16	—	—	—	38615	38615
7	Plug – Carrier Cover	17	—	—	—	43180	43180
8	Gear – Differential (std)	26	—	—	—	33213	33213
9	Thrustwasher – Diff Gear (std)	28	—	—	—	40027	40027
10	KIT – Right Knuckle Assembly	-	74386X	74507X	74386X	74507X	74386X
11	KIT – Left Knuckle Assembly	-	74387X	74508X	74387X	74508X	74387X
12	KIT – Socket Assembly	-	706944X	706944X	706944X	706944X	706944X
13	Nut – Slotted	32	43682	43682	43682	43682	43682
14	Adjusting Split Ring	34	40586	40586	40586	40586	40586
15	Socket Assembly	35	40583	40583	40583	40583	40583
16	Nut – Hex Jam / Slotted	36	40584	40584	40584	40584	40584
17	Socket Assembly	37	40916	40916	40916	40916	40916
18	Snap Ring	38	—	—	—	—	—
19	Bolt – Knuckle	39	41027	41027	41027	41027	41027
20	Right Knuckle	40	44181	44322	44181	44322	44181
21	Left Knuckle	41	44182	44323	44182	44323	44182
22	Slinger – Spindle Yoke (Inner)	46	—	—	—	46849	46849
23	Slinger – Spindle Yoke (Outer)	47	—	46988	—	46988	—
24	KIT – Spindle Seal & Bearing	-	—	—	—	—	—
25	KIT – Spindle	-	—	—	—	—	—
26	Oil Seal	48	—	—	—	—	—
27	Oil Seal (block vee)	49	—	—	—	—	—
28	Spacer – Wheel Bearing Spindle	50	—	—	—	—	—
29	Needle Bearing Assembly	51	—	—	—	—	—
30	Spindle – Wheel Bearing	52	—	—	—	—	—
31	KIT – Inner Wheel Bearing	55	—	—	—	—	—
32	KIT – Outer Wheel Bearing	57	—	—	—	—	—
33	Lockwasher – Wheel Bearing	58	—	—	—	—	—
34	Nut – Wheel Bearing	59	—	—	—	—	—
35	Lockwasher – Wheel Bearing Nut	60	—	—	—	—	—
36	Gasket – Drive Flange	61	—	—	—	—	—
37	Flange – Axle Drive	62	—	—	—	—	—
38	Snap Ring	63	—	—	—	—	—
39	Hub Cap	64	—	—	—	—	—
40	Lockwasher	66	—	—	—	—	—
41	Hub Assembly	67	43355	43355	43355	43355	43355
42	Tone Ring (ABS)/Slinger	72	44646	—	44646	—	44646
43	Spring – Wave Washer	73	45749	45749	45749	45749	45749

(See next page for additional bills of material)

Jeep Model 30 /181 Front Variable Parts Listing

Kits & Parts - Use With All Applications							
Description & Item Number (Refer to "Exploded View" at the front of this section)			Bills of Material				
			610673	610674	610675	610676	610677
1	Seal – Pinion Oil	10	44895	44895	44895	44895	44895
2	End Yoke or Assembly (inc 12)	11	2-4-6561-1	2-4-6561-1	2-4-6561-1	2-4-6561-1	2-4-6561-1
3	Slinger – End Yoke	12	—	—	—	—	—
4	KIT – Carrier Cover	-	707180X	707180X	707180X	707180X	707180X
5	Carrier Cover	15	40869	40869	40869	40869	40869
6	Gasket/RTV Silicone Sealant	16	38615	38615	38615	38615	38615
7	Plug – Carrier Cover	17	43180	43180	43180	43180	43180
8	Gear – Differential (std)	26	33213	33213	33213	33213	33213
9	Thrustwasher – Diff Gear (std)	28	40027	40027	40027	40027	40027
10	KIT – Right Knuckle Assembly	-	74507X	74386X	74507X	74386X	74507X
11	KIT – Left Knuckle Assembly	-	74508X	74387X	74508X	74387X	74508X
12	KIT – Socket Assembly	-	706944X	706944X	706944X	706944X	706944X
13	Nut – Slotted	32	43682	43682	43682	43682	43682
14	Adjusting Split Ring	34	40586	40586	40586	40586	40586
15	Socket Assembly	35	40583	40583	40583	40583	40583
16	Nut – Hex Jam / Slotted	36	40584	40584	40584	40584	40584
17	Socket Assembly	37	40916	40916	40916	40916	40916
18	Snap Ring	38	—	—	—	—	—
19	Bolt – Knuckle	39	41027	41027	41027	41027	41027
20	Right Knuckle	40	44322	44181	44322	44181	44322
21	Left Knuckle	41	44323	44182	44323	44182	44323
22	Slinger – Spindle Yoke (Inner)	46	46849	—	46849	46849	46849
23	Slinger – Spindle Yoke (Outer)	47	46988	46849	46988	—	46988
24	KIT – Spindle Seal & Bearing	-	—	—	—	—	—
25	KIT – Spindle	-	—	—	—	—	—
26	Oil Seal	48	—	—	—	—	—
27	Oil Seal (block vee)	49	—	—	—	—	—
28	Spacer – Wheel Bearing Spindle	50	—	—	—	—	—
29	Needle Bearing Assembly	51	—	—	—	—	—
30	Spindle – Wheel Bearing	52	—	—	—	—	—
31	KIT – Inner Wheel Bearing	55	—	—	—	—	—
32	KIT – Outer Wheel Bearing	57	—	—	—	—	—
33	Lockwasher – Wheel Bearing	58	—	—	—	—	—
34	Nut – Wheel Bearing	59	—	—	—	—	—
35	Lockwasher – Wheel Bearing Nut	60	—	—	—	—	—
36	Gasket – Drive Flange	61	—	—	—	—	—
37	Flange – Axle Drive	62	—	—	—	—	—
38	Snap Ring	63	—	—	—	—	—
39	Hub Cap	64	—	—	—	—	—
40	Lockwasher	66	—	—	—	—	—
41	Hub Assembly	67	43355	43355	43355	43355	43355
42	Tone Ring/Slinger	72	—	44646	—	44646	—
43	Spring – Wave Washer	73	45749	45749	45749	45749	45749

(See next page for additional bills of material)

Jeep Model 30 /181 Front Variable Parts Listing

Kits & Parts - Use With All Applications							
Description & Item Number (Refer to "Exploded View" at the front of this section)			Bills of Material				
			610678	610758	610759	610760	610761
1	Seal – Pinion Oil	10	44895	44895	44895	44895	44895
2	End Yoke or Assembly (inc 12)	11	2-4-6561-1	2-4-6561-1	2-4-6561-1	2-4-6561-1	2-4-6561-1
3	Slinger – End Yoke	12	—	—	—	—	—
4	KIT – Carrier Cover	-	707180X	707180X	707180X	707180X	707180X
5	Carrier Cover	15	40869	40869	40869	40869	40869
6	Gasket/RTV Silicone Sealant	16	38615	38615	38615	38615	38615
7	Plug – Carrier Cover	17	43180	43180	43180	43180	43180
8	Gear – Differential (std)	26	33213	33213	33213	33213	33213
9	Thrustwasher – Diff Gear (std)	28	40027	40027	40027	40027	40027
10	KIT – Right Knuckle Assembly	-	74386X	74507X	74386X	74507X	74386X
11	KIT – Left Knuckle Assembly	-	74387X	74508X	74387X	74508X	74387X
12	KIT – Socket Assembly	-	706944X	706944X	706944X	706944X	706944X
13	Nut – Slotted	32	43682	43682	43682	43682	43682
14	Adjusting Split Ring	34	40586	40586	40586	40586	40586
15	Socket Assembly	35	40583	40583	40583	40583	40583
16	Nut – Hex Jam / Slotted	36	40584	40584	40584	40584	40584
17	Socket Assembly	37	40916	40916	40916	40916	40916
18	Snap Ring	38	—	—	—	—	—
19	Bolt – Knuckle	39	41027	41027	41027	41027	41027
20	Right Knuckle	40	44181	44322	44181	44322	44181
21	Left Knuckle	41	44182	44323	44182	44323	44182
22	Slinger – Spindle Yoke (Inner)	46	46849	46849	46849	46849	46849
23	Slinger – Spindle Yoke (Outer)	47	—	46988	—	46988	—
24	KIT – Spindle Seal & Bearing	-	—	—	—	—	—
25	KIT – Spindle	-	—	—	—	—	—
26	Oil Seal	48	—	—	—	—	—
27	Oil Seal (block vee)	49	—	—	—	—	—
28	Spacer – Wheel Bearing Spindle	50	—	—	—	—	—
29	Bearing Assembly – Needle	51	—	—	—	—	—
30	Spindle – Wheel Bearing	52	—	—	—	—	—
31	KIT – Inner Wheel Bearing	55	—	—	—	—	—
32	KIT – Outer Wheel Bearing	57	—	—	—	—	—
33	Lockwasher – Wheel Bearing	58	—	—	—	—	—
34	Nut – Wheel Bearing	59	—	—	—	—	—
35	Lockwasher – Wheel Bearing Nut	60	—	—	—	—	—
36	Gasket – Drive Flange	61	—	—	—	—	—
37	Flange – Axle Drive	62	—	—	—	—	—
38	Snap Ring	63	—	—	—	—	—
39	Hub Cap	64	—	—	—	—	—
40	Lockwasher	66	—	—	—	—	—
41	Hub Assembly	67	43355	49773	49773	49773	49773
42	Tone Ring/Slinger	72	44646	—	44646	—	44646
43	Spring – Wave Washer	73	45749	45749	45749	45749	45749

(See next page for additional bills of material)

Jeep Model 30 /181 Front Variable Parts Listing

Kits & Parts - Use With All Applications							
Description & Item Number (Refer to "Exploded View" at the front of this section)			Bills of Material				
			610762	610763	610764	610765	610766
1	Seal – Pinion Oil	10	44895	44895	44895	44895	—
2	End Yoke or Assembly (inc 12)	11	2-4-6561-1	2-4-6561-1	2-4-6561-1	2-4-6561-1	—
3	Slinger – End Yoke	12	—	—	—	—	—
4	KIT – Carrier Cover	-	707180X	707180X	707180X	707180X	—
5	Carrier Cover	15	40869	40869	40869	40869	—
6	Gasket/RTV Silicone Sealant	16	38615	38615	38615	38615	—
7	Plug – Carrier Cover	17	43180	43180	43180	43180	—
8	Gear – Differential (std)	26	33213	33213	33213	33213	—
9	Thrustwasher – Diff Gear (std)	28	40027	40027	40027	40027	—
10	KIT – Right Knuckle Assembly	-	74507X	74386X	74507X	74386X	74507X
11	KIT – Left Knuckle Assembly	-	74508X	74387X	74508X	74387X	74508X
12	KIT – Socket Assembly	-	706944X	706944X	706944X	706944X	706944X
13	Nut – Slotted	32	43682	43682	43682	43682	43682
14	Adjusting Split Ring	34	40586	40586	40586	40586	40586
15	Socket Assembly	35	40583	40583	40583	40583	40583
16	Nut – Hex Jam / Slotted	36	40584	40584	40584	40584	40584
17	Socket Assembly	37	40916	40916	40916	40916	40916
18	Snap Ring	38	—	—	—	—	—
19	Bolt – Knuckle	39	41027	41027	41027	41027	41027
20	Right Knuckle	40	44322	44181	44322	44181	44322
21	Left Knuckle	41	44323	44182	44323	44182	44323
22	Slinger – Spindle Yoke (Inner)	46	46849	46849	46849	46849	—
23	Slinger – Spindle Yoke (Outer)	47	46988	—	46988	—	46988
24	KIT – Spindle Seal & Bearing	-	—	—	—	—	—
25	KIT – Spindle	-	—	—	—	—	—
26	Oil Seal	48	—	—	—	—	—
27	Oil Seal (block vee)	49	—	—	—	—	—
28	Spacer – Wheel Bearing Spindle	50	—	—	—	—	—
29	Bearing Assembly – Needle	51	—	—	—	—	—
30	Spindle – Wheel Bearing	52	—	—	—	—	—
31	KIT – Inner Wheel Bearing	55	—	—	—	—	—
32	KIT – Outer Wheel Bearing	57	—	—	—	—	—
33	Lockwasher – Wheel Bearing	58	—	—	—	—	—
34	Nut – Wheel Bearing	59	—	—	—	—	—
35	Lockwasher – Wheel Bearing Nut	60	—	—	—	—	—
36	Gasket – Drive Flange	61	—	—	—	—	—
37	Flange – Axle Drive	62	—	—	—	—	—
38	Snap Ring	63	—	—	—	—	—
39	Hub Cap	64	—	—	—	—	—
40	Lockwasher	66	—	—	—	—	—
41	Hub Assembly	67	49773	49773	49773	49773	49773
42	Tone Ring/Slinger	72	—	44646	—	44646	—
43	Spring – Wave Washer	73	45749	45749	45749	45749	45749

(See next page for additional bills of material)

Jeep Model 30 /181 Front Variable Parts Listing

Kits & Parts - Use With All Applications							
Description & Item Number (Refer to "Exploded View" at the front of this section)			Bills of Material				
			610767	610768	610769	610849	610850
1	Seal – Pinion Oil	10	—	—	—	44895	44895
2	End Yoke or Assembly (inc 12)	11	—	—	—	2-4-6561-1	2-4-6561-1
3	Slinger – End Yoke	12	—	—	—	—	—
4	KIT – Carrier Cover	-	—	—	—	707180X	707180X
5	Carrier Cover	15	—	—	—	40869	40869
6	Gasket/RTV Silicone Sealant	16	—	—	—	38615	38615
7	Plug – Carrier Cover	17	—	—	—	43180	43180
8	Gear – Differential (std)	26	—	—	—	33213	33213
9	Thrustwasher – Diff Gear (std)	28	—	—	—	40027	40027
10	KIT – Right Knuckle Assembly	-	74386X	74507X	74386X	74507X	74386X
11	KIT – Left Knuckle Assembly	-	74387X	74508X	74387X	74508X	74387X
12	KIT – Socket Assembly	-	706944X	706944X	706944X	706944X	706944X
13	Nut – Slotted	32	43682	43682	43682	43682	43682
14	Adjusting Split Ring	34	40586	40586	40586	40586	40586
15	Socket Assembly	35	40583	40583	40583	40583	40583
16	Nut – Hex Jam / Slotted	36	40584	40584	40584	40584	40584
17	Socket Assembly	37	40916	40916	40916	40916	40916
18	Snap Ring	38	—	—	—	—	—
19	Bolt – Knuckle	39	41027	41027	41027	41027	41027
20	Right Knuckle	40	44181	44322	44181	44322	44181
21	Left Knuckle	41	44182	44323	44182	44323	44182
22	Slinger-Spindle Yoke (Inner)	46	—	—	—	46849	46849
23	Slinger – Spindle Yoke (Outer)	47	—	46988	—	46988	—
24	KIT – Spindle Seal & Bearing	-	—	—	—	—	—
25	KIT – Spindle	-	—	—	—	—	—
26	Oil Seal	48	—	—	—	—	—
27	Oil Seal (block vee)	49	—	—	—	—	—
28	Spacer – Wheel Bearing Spindle	50	—	—	—	—	—
29	Needle Bearing Assembly	51	—	—	—	—	—
30	Spindle – Wheel Bearing	52	—	—	—	—	—
31	KIT – Inner Wheel Bearing	55	—	—	—	—	—
32	KIT – Outer Wheel Bearing	57	—	—	—	—	—
33	Lockwasher – Wheel Bearing	58	—	—	—	—	—
34	Nut – Wheel Bearing	59	—	—	—	—	—
35	Lockwasher – Wheel Bearing Nut	60	—	—	—	—	—
36	Gasket – Drive Flange	61	—	—	—	—	—
37	Flange – Axle Drive	62	—	—	—	—	—
38	Snap Ring	63	—	—	—	—	—
39	Hub Cap	64	—	—	—	—	—
40	Lockwasher	66	—	—	—	—	—
41	Hub Assembly	67	49773	49773	49773	49773	49773
42	Tone Ring/Slinger	72	44646	—	44646	—	44646
43	Spring – Wave Washer	73	45749	45749	45749	45749	45749

(See next page for additional bills of material)

Jeep Model 30 /181 Front Variable Parts Listing

Kits & Parts - Use With All Applications							
Description & Item Number (Refer to "Exploded View" at the front of this section)			Bills of Material				
			610851	610852	610853	610854	610855
1	Seal – Pinion Oil	10	44895	44895	44895	—	—
2	End Yoke or Assembly (inc 12)	11	2-4-6561-1	2-4-6561-1	2-4-6561-1	—	—
3	Slinger – End Yoke	12	—	—	—	—	—
4	KIT – Carrier Cover	-	707180X	707180X	707180X	—	—
5	Carrier Cover	15	40869	40869	40869	—	—
6	Gasket/RTV Silicone Sealant	16	38615	38615	38615	—	—
7	Plug – Carrier Cover	17	43180	43180	43180	—	—
8	Gear – Differential (std)	26	33213	33213	33213	—	—
9	Thrustwasher – Diff Gear (std)	28	40027	40027	40027	—	—
10	KIT – Right Knuckle Assembly	-	74507X	74386X	74386X	74507X	74386X
11	KIT – Left Knuckle Assembly	-	74508X	74387X	74387X	74508X	74387X
12	KIT – Socket Assembly	-	706944X	706944X	706944X	706944X	706944X
13	Nut – Slotted	32	43682	43682	43682	43682	43682
14	Adjusting Split Ring	34	40586	40586	40586	40586	40586
15	Socket Assembly	35	40583	40583	40583	40583	40583
16	Nut – Hex Jam / Slotted	36	40584	40584	40584	40584	40584
17	Socket Assembly	37	40916	40916	40916	40916	40916
18	Snap Ring	38	—	—	—	—	—
19	Bolt – Knuckle	39	41027	41027	41027	41027	41027
20	Right Knuckle	40	44322	44181	44181	44322	44181
21	Left Knuckle	41	44323	44182	44182	44323	44182
22	Slinger-Spindle Yoke (Inner)	46	46849	46849	46849	—	—
23	Slinger – Spindle Yoke (Outer)	47	46988	—	—	46988	—
24	KIT – Spindle Seal & Bearing	-	—	—	—	—	—
25	KIT – Spindle	-	—	—	—	—	—
26	Oil Seal	48	—	—	—	—	—
27	Oil Seal (block vee)	49	—	—	—	—	—
28	Spacer – Wheel Bearing Spindle	50	—	—	—	—	—
29	Needle Bearing Assembly	51	—	—	—	—	—
30	Spindle – Wheel Bearing	52	—	—	—	—	—
31	KIT – Inner Wheel Bearing	55	—	—	—	—	—
32	KIT – Outer Wheel Bearing	57	—	—	—	—	—
33	Lockwasher – Wheel Bearing	58	—	—	—	—	—
34	Nut – Wheel Bearing	59	—	—	—	—	—
35	Lockwasher – Wheel Bearing Nut	60	—	—	—	—	—
36	Gasket – Drive Flange	61	—	—	—	—	—
37	Flange – Axle Drive	62	—	—	—	—	—
38	Snap Ring	63	—	—	—	—	—
39	Hub Cap	64	—	—	—	—	—
40	Lockwasher	66	—	—	—	—	—
41	Hub Assembly	67	49773	49773	49773	49773	49773
42	Tone Ring/Slinger	72	—	44646	44646	—	44646
43	Spring – Wave Washer	73	45749	45749	45749	45749	45749

(See next page for additional bills of material)

Jeep / Eagle 1984-1996

**Model 30 /181 Disconnect
Front Axles for**

**XJ (Cherokee /Comanche)
YJ /TJ (Wrangler)**

Jeep Model 30 /181 Disconnect Front Parts Listing

ITEM NO.	PART NUMBER	DESCRIPTION	ITEM NO.	PART NUMBER	DESCRIPTION
1	— ⁽³⁾	Housing – Axle Service	37	40584	Nut – Hex Jam
2	— ⁽¹⁾	Drive Pinion & Gear Assembly	38	—	Snap Ring
3	— ⁽²⁾	Slinger – Variable Thicknesses	39	— ⁽³⁾	Nut – Hex Slotted
4	706015X	KIT – Inner Pinion Bearing	40	— ⁽³⁾	Cotter Pin
	706936X	PKG – Pinion Bearing Shim (inc 5,7,12,13,16,54,55,63,70)	41	— ⁽⁵⁾	Tie Rod Assembly
	706938X	PKG – Diff & Pinion Bearing Shim (inc 5,7,12,13,16,22,54,55,63,70)		— ⁽²⁾	KIT – Right Knuckle Assembly (inc items 35, 36, 42, 44)
5	—	Inner Pinion Bearing Shims (see shim packages)	42	— ⁽²⁾	KIT – Left Knuckle Assembly (inc items 35, 36, 43, 44)
6	32349	Baffle - Pinion Bearing	43	— ⁽²⁾	Right Knuckle
7	—	Outer Pinion Bearing Shims (see shim packages)	44	41027	Left Knuckle
8	706030X	KIT – Outer Pinion Bearing	45	— ⁽¹⁾	Bolt – Knuckle
9	13575	Slinger – Outer Pinion Bearing	46	— ⁽²⁾	Shaft & Joint Assembly
10	39118	Seal – Pinion Oil	47	— ⁽²⁾	Slinger – Outer Shaft /Tone Ring (ABS)
11	— ⁽²⁾	End Yoke or Assembly (inc 11A)	48	— ⁽²⁾	Slinger – Inner Shaft
12	— ⁽²⁾	Slinger – End Yoke	49	40596	Hub Assembly
13	30186	Washer – Pinion Nut	50	40597	Washer – Flat
14	30185	Pinion Nut	51	42570	Nut – Hex
	— ⁽²⁾	KIT – Carrier Cover (inc items 15, 16, 17, 18)		— ⁽²⁾	Snap Ring
15	40869	Carrier Cover		706941X	KIT – Motor Assembly (inc items 52,53,54,55,58,59,61,63)
16	38615	Gasket – Carrier Cover		706824X	KIT – Shift Fork (53,54,55,58,59,60,61,63)
17	— ⁽²⁾	Plug – Carrier Cover			KIT – Shift Clip (inc items 54, 55, 61, 63)
18	34279	Bolt – Carrier Cover (qty 10)	52	— ⁽²⁾	Motor Assembly
19	— ⁽³⁾	Differential Bearing Cap	53	620980	O-Ring
20	48631-1	Bolt – Differential Bearing Cap	54	— ⁽²⁾	Cap Screw
21	706016X	KIT – Differential Bearing	55	500357-9	Lockwasher
22	706937X	PKG – Differential Bearing Shim (inc items 16, 54, 55, 63,70)	56	— ⁽²⁾	Cover – Disconnect Housing
			57	— ⁽²⁾	Switch Assembly
23	— ⁽⁴⁾	Case – Differential	58	621097	Snap Ring
24	41221	Bolt – Drive Gear (qty 10)	59	620979	Snap Ring
25	— ⁽²⁾	Gear – Differential	60	42585	Shift Fork
26	32926	Pinion – Differential	61	621059	Clip – Shift Fork
27	34096	Thrustwasher – Differential Pinion	62	42998	Clutch Collar
28	40027	Thrustwasher – Differential Gear	63	41494	Gasket
29	32915	Shaft – Differential	64	— ⁽²⁾	Bushing/Bearing
30	13449	Lock – Differential Shaft	65	— ⁽²⁾	Oil Seal
31	36362	Oil Seal	66	— ⁽²⁾	Guide – Axle Shaft
	706944X	KIT – Socket Assy (32,33,34,35,36,37)	67	— ⁽²⁾	Bushing/Bearing
32	43682	Nut – Slotted	68	— ⁽²⁾	Shaft – Output
33	500024-6	Cotter Pin	69	40598	Retainer Nut
34	40586	Adjusting Split Ring	70	500025-10	Cotter Pin
35	40583	Socket Assembly	71	— ⁽²⁾	Spring – Wave Washer
36	40916	Socket Assembly			

(1) See "Bill of Material Table" on next page

(2) See "Variable Parts Table" within this section

(3) Contact Vehicle Manufacturer

(4) Not Sold Separately

(5) See Spicer Chassis Catalog for part number and additional steering parts

Jeep Model 30 /181 Disconnect Front Bill of Material Table

Axle			Axle Kits				Shaft & Joint Assy.	
Bill of Material	Diff. Type	Ratio	Ring Gear & Pinion Kit ⁽⁷⁾	Differential			Right Hand Shaft Assy.	Left Hand Shaft Assy.
				Case Assy. Kit ⁽⁸⁾	Case Kit	Inner Parts Kit		
1984 XJ Disconnect, CV								
610172-2	Standard	3.73	706930-5X	706932X	706934X	706935X	72080-1X	72081-1X
610172-8	Standard	3.07	706930-2X	706931X	706933X	706935X	72080-1X	72081-1X
610172-9	Standard	3.31	706930-3X	706931X	706933X	706935X	72080-1X	72081-1X
1984-85 XJ Disconnect, Cardan, System Sentry								
610182-1	Standard	3.73	706930-5X	706932X	706934X	706935X	75588-1X	75587-1X
610182-3	Standard	3.31	706930-3X	706931X	706933X	706935X	75588-1X	75587-1X
610182-7	Standard	3.54	706930-8X	706931X	706933X	706935X	75588-1X	75587-1X
610182-8	Standard	4.10	706930-4X	706932X	706934X	706935X	75588-1X	75587-1X
610182-10	Standard	3.31	706930-3X	706931X	706933X	706935X	75588-1X	75587-1X
610182-11	Standard	3.73	706930-5X	706932X	706934X	706935X	75588-1X	75587-1X
1984-87 XJ Disconnect, Cardan								
610175-1	Standard	3.54	706930-8X	706931X	706933X	706935X	75588-1X	75587-1X
610175-2	Standard	3.73	706930-5X	706932X	706934X	706935X	75588-1X	75587-1X
610175-3	Standard	4.10	706930-4X	706932X	706934X	706935X	75588-1X	75587-1X
610175-5	Standard	4.56	706930-6X	706932X	706934X	706935X	75588-1X	75587-1X
610175-8	Standard	3.07	706930-2X	706931X	706933X	706935X	75588-1X	75587-1X
610175-9	Standard	3.31	706930-3X	706931X	706933X	706935X	75588-1X	75587-1X
1986 YJ Disconnect								
610259-1	Standard	2.72	706930-7X	706931X	706933X	706935X	75588-1X	75587-1X
610259-2	Standard	3.07	706930-2X	706931X	706933X	706935X	75588-1X	75587-1X
610259-3	Standard	3.54	706930-8X	706931X	706933X	706935X	75588-1X	75587-1X
610259-4	Standard	4.10	706930-4X	706932X	706934X	706935X	75588-1X	75587-1X
1987-88 YJ Disconnect								
610281-1	Standard	2.72	706930-7X	706931X	706933X	706935X	75588-1X	75587-1X
610281-2	Standard	3.07	706930-2X	706931X	706933X	706935X	75588-1X	75587-1X
610281-3	Standard	3.54	706930-8X	706931X	706933X	706935X	75588-1X	75587-1X
610281-4	Standard	4.10	706930-4X	706932X	706934X	706935X	75588-1X	75587-1X
610281-5	Standard	3.55	706930-8X	706931X	706933X	706935X	75588-1X	75587-1X
1987 1/2-88 XJ Disconnect								
610279-1	Standard	3.54	706930-8X	706931X	706933X	706935X	72324-1X	71859-1X
610279-2	Standard	3.73	706930-5X	706932X	706934X	706935X	72324-1X	71859-1X
610279-3	Standard	4.10	706930-4X	706932X	706934X	706935X	72324-1X	71859-1X
610279-4	Standard	4.56	706930-6X	706932X	706934X	706935X	72324-1X	71859-1X
610279-5	Standard	3.07	706930-2X	706931X	706933X	706935X	72324-1X	71859-1X
610279-6	Standard	3.31	706930-3X	706931X	706933X	706935X	72324-1X	71859-1X
610279-10	Standard	3.55	706930-8X	706931X	706933X	706935X	72324-1X	71859-1X
1988 XJ Disconnect, Valeo Export								
610297-3	Standard	4.10	706930-4X	706932X	706934X	706935X	75588-1X	75587-1X
610297-4	Standard	3.07	706930-2X	706931X	706933X	706935X	75588-1X	75587-1X
1988 1/2-89 XJ Disconnect								
610321-3	Standard	4.10	706930-4X	706932X	706934X	706935X	75588-1X	75587-1X
610321-4	Standard	4.56	706930-6X	706932X	706934X	706935X	75588-1X	75587-1X
610321-5	Standard	3.31	706930-2X	706931X	706933X	706935X	75588-1X	75587-1X
610321-10	Standard	3.55	706930-8X	706931X	706933X	706935X	75588-1X	75587-1X
1988 1/2-89 YJ Disconnect								
610323-2	Standard	3.07	706930-2X	706931X	706933X	706935X	75588-1X	75587-1X
610323-4	Standard	4.10	706930-4X	706932X	706934X	706935X	75588-1X	75587-1X
610323-5	Standard	3.55	706930-8X	706931X	706933X	706935X	75588-1X	75587-1X

NOTE: All Ring & Pinion Kits with base number 706930 are reverse spiral bevel
 (7) See Ring Gear & Pinion Kits in XGI Catalog for ratio & tooth combinations.
 (8) See Differential Case Assy Kits in XGI Catalog for spline data & ratios.

Jeep Model 30 /181 Disconnect Front Bill of Material Table

Axle			Axle Kits				Shaft & Joint Assy.	
Bill of Material	Diff. Type	Ratio	Ring Gear & Pinion Kit ⁽⁷⁾	Differential			Right Hand Shaft Assy.	Left Hand Shaft Assy.
				Case Assy. Kit ⁽⁸⁾	Case Kit	Inner Parts Kit		
1988 1/2-89 XJ Disconnect, Valeo Export								
610328-3	Standard	4.10	706930-4X	706932X	706934X	706935X	75588-1X	75587-1X
610328-4	Standard	3.07	706930-2X	706931X	706933X	706935X	75588-1X	75587-1X
1990-90 1/2 XJ Disconnect								
610317-3	Standard	4.10	706930-4X	707159X	706934X	707160X	75588-1X	75587-1X
610317-4	Standard	4.56	706930-6X	707159X	706934X	707160X	75588-1X	75587-1X
610317-5	Standard	3.07	706930-2X	707158X	706933X	707160X	75588-1X	75587-1X
610317-7	Standard	3.55	706930-8X	707158X	706933X	707160X	75588-1X	75587-1X
1990-90 1/2 YJ Disconnect								
610319-2	Standard	3.07	706930-2X	707158X	706933X	707160X	75588-1X	75587-1X
610319-4	Standard	4.10	706930-4X	707159X	706934X	707160X	75588-1X	75587-1X
610319-5	Standard	3.55	706930-8X	707158X	706933X	707160X	75588-1X	75587-1X
1990-90 1/2 XJ Disconnect, Valeo Export								
610339-1	Standard	4.10	706930-4X	707159X	706934X	707160X	75588-1X	75587-1X
610339-2	Standard	3.07	706930-2X	707158X	706933X	707160X	75588-1X	75587-1X
1991 XJ Disconnect								
610363-1	Standard	4.10	706930-4X	707159X	706934X	707160X	75588-1X	75587-1X
610363-2	Standard	3.07	706930-2X	707158X	706933X	707160X	75588-1X	75587-1X
1991-91 1/2 XJ Disconnect								
610361-3	Standard	4.10	706930-4X	707159X	706934X	707160X	75588-1X	75587-1X
610361-4	Standard	4.56	706930-6X	707159X	706934X	707160X	75588-1X	75587-1X
610361-5	Standard	3.07	706930-2X	707158X	706933X	707160X	75588-1X	75587-1X
610361-7	Standard	3.55	706930-8X	707158X	706933X	707160X	75588-1X	75587-1X
1991-91 1/2 YJ Disconnect								
610362-2	Standard	3.07	706930-2X	707158X	706933X	707160X	75588-1X	75587-1X
610362-4	Standard	4.10	706930-4X	707159X	706934X	707160X	75588-1X	75587-1X
610362-5	Standard	3.55	706930-8X	707158X	706933X	707160X	75588-1X	75587-1X
1991 1/2 XJ Disconnect								
610401-3	Standard	4.10	706930-4X	707159X	706934X	707160X	75588-1X	75587-1X
610401-5	Standard	3.07	706930-2X	707158X	706933X	707160X	75588-1X	75587-1X
610401-7	Standard	3.55	706930-8X	707158X	706933X	707160X	75588-1X	75587-1X
1992-93 1/2 YJ Disconnect								
610393-2	Standard	3.07	706930-2X	707158X	706933X	707160X	75588-1X	75587-1X
610393-4	Standard	4.10	706930-4X	707159X	706934X	707160X	75588-1X	75587-1X
610393-5	Standard	3.55	706930-8X	707158X	706933X	707160X	75588-1X	75587-1X
610393-6	Standard	3.73	706930-5X	707159X	706934X	707160X	75588-1X	75587-1X
1993-93 1/2 YJ Disconnect ABS								
610381-2	Standard	3.07	706930-2X	707158X	706933X	707160X	75589-1X	75815-1X
610381-5	Standard	3.55	706930-8X	707158X	706933X	707160X	75589-1X	75815-1X
1994-96 YJ Disconnect								
610461-2	Standard	3.07	706930-2X	707158X	706933X	707160X	75588-1X	75587-1X
610461-4	Standard	4.10	706930-4X	707159X	706934X	707160X	75588-1X	75587-1X
610461-5	Standard	3.55	706930-8X	707158X	706933X	707160X	75588-1X	75587-1X
610461-6	Standard	3.73	706930-5X	707159X	706934X	707160X	75588-1X	75587-1X
1994-96 YJ Disconnect ABS								
610462-2	Standard	3.07	706930-2X	707158X	706933X	707160X	75589-1X	75815-1X
610462-5	Standard	3.55	706930-8X	707158X	706933X	707160X	75589-1X	75815-1X
610462-6	Standard	3.07	706930-2X	707158X	706933X	707160X	75589-1X	75815-1X
610462-7	Standard	3.55	706930-8X	707158X	706933X	707160X	75589-1X	75815-1X

NOTE: All Ring & Pinion Kits with base number 706930 are reverse spiral bevel
 (7) See Ring Gear & Pinion Kits in XGI Catalog for ratio & tooth combinations.
 (8) See Differential Case Assy Kits in XGI Catalog for spline data & ratios.

Jeep Model 30 /181 Disconnect Front Variable Parts Listing

Kits & Parts - Use With All Applications							
Description & Item Number (Refer to "Exploded View" at the front of this section)			Bills of Material				
			610172	610175	610182 610259	610279 610281 610297	610317 610319
1	Slinger – Variable Thicknesses	3	30764	30764	30764	30764	44035
2	End Yoke or Assembly (inc 11A)	11	2-4-6771-1X	2-4-6771-1X	2-4-8091-1X	2-4-6561-1	2-4-6561-1
3	Slinger – End Yoke	12	41498	41498	41498	—	—
4	KIT – Carrier Cover	-	706943X	706943X	706943X	706943X	707180X
5	Plug – Carrier Cover	17	36924	36924	36924	36924	43180
6	Gear – Differential	25	620486	620486	620486	620486	33213
7	KIT – Right Knuckle Assembly	-	—	—	—	—	74507X
8	KIT – Left Knuckle Assembly	-	—	—	—	—	74508X
9	Right Knuckle	42	40707	40707	40707	40707	43351
10	Left Knuckle	43	40579	40579	40579	40579	43352
11	Slinger – Outer Shaft/Tone Ring(ABS)	46	40589	40589	40589	40589	40589
12	Slinger – Inner Shaft	47	—	701113X	701113X	701113X	—
13	Hub Assembly	48	40592	40592	40592	40592	43355
14	KIT – Motor Assembly	-	707078X	707078X	707078X	707078X	707078X
15	Motor Assembly	52	42486	42486	42486	42486	42486
16	Cap Screw	54	500396-9	500396-9	500396-9	500396-9	500396-10
17	Cover – Disconnect Housing	56	40603	40603	40603	40603	40603
18	Switch Assembly	57	—	—	—	—	—
19	Bushing/Bearing	64	565985	565985	565985	565985	43337
20	Oil Seal	65	40570	40570	40570	42500	42500
21	Guide – Axle Shaft	66	42039	42039	42039	—	—
22	Bushing/Bearing	67	621000	621000	621000	621000	43342
23	Shaft – Output	68	40600-1	40600-1	40600-1	40600-1	43361-1
24	Spring – Wave Washer	71	—	—	—	—	—
			610321 610323 610328	610339	610361 610362	610363	610381
1	Slinger – Variable Thicknesses	3	30764	30764	44035	30764	44035
2	End Yoke or Assembly (inc 11A)	11	2-4-6561-1	2-4-6561-1	2-4-6561-1	2-4-6561-1	2-4-6561-1
3	Slinger – End Yoke	12	—	—	—	—	—
4	KIT – Carrier Cover	-	707180X	707180X	707180X	707180X	707180X
5	Plug – Carrier Cover	17	43180	43180	43180	43180	43180
6	Gear – Differential	25	620486	33213	33213	33213	33213
7	KIT – Right Knuckle Assembly	-	—	74507X	74507X	74507X	74386X
8	KIT – Left Knuckle Assembly	-	—	74508X	74508X	74508X	74387X
9	Right Knuckle	42	40707	43351	43351	44322	44181
10	Left Knuckle	43	40579	43352	43352	44323	44182
11	Slinger – Outer Shaft/Tone Ring(ABS)	46	40589	40589	40589	40589	—
12	Slinger – Inner Shaft	47	—	—	—	—	—
13	Hub Assembly	48	40592	43355	43355	43355	43355
14	KIT – Motor Assembly	-	707078X	707078X	707245X	707245X	707245X
15	Motor Assembly	52	42486	42486	43429	43429	43429
16	Cap Screw	54	500396-10	500396-10	500396-10	500396-10	500396-9
17	Cover – Disconnect Housing	56	40603	40603	42208	42208	42208
18	Switch Assembly	57	—	—	44060	44060	44060
19	Bushing/Bearing	64	565985	43337	43337	43337	43337
20	Oil Seal	65	42500	42500	42500	42500	42500
21	Guide – Axle Shaft	66	—	—	—	—	—
22	Bushing/Bearing	67	621000	43342	43342	43342	43342
23	Shaft – Output	68	40600-1	43361-1	43361-1	43361-1	43361-1
24	Spring – Wave Washer	71	—	—	—	—	45749

Jeep Model 30 /181 Disconnect Front Variable Parts Listing

Kits & Parts - Use With All Applications							
Description & Item Number (Refer to "Exploded View" at the front of this section)			Bills of Material				
			610393	610401	610461	610462	
1	Slinger – Variable Thicknesses	3	44035	44035	44035	44035	
2	End Yoke or Assembly (inc 11A)	11	2-4-6561-1	2-4-6561-1	2-4-6561-1	2-4-6561-1	
3	Slinger – End Yoke	12	—	—	—	—	
4	KIT – Carrier Cover	-	707180X	707180X	707180X	707180X	
5	Plug – Carrier Cover	17	43180	43180	43180	43180	
6	Gear – Differential	25	33213	33213	33213	33213	
7	KIT – Right Knuckle Assembly	-	74507X	74507X	74507X	74386X	
8	KIT – Left Knuckle Assembly	-	74508X	74508X	74508X	74387X	
9	Right Knuckle	42	44322	44322	44322	44181	
10	Left Knuckle	43	44323	44323	44323	44182	
11	Slinger – Outer Shaft/Tone Ring(ABS)	46	40589	40589	46988	—	
12	Slinger – Inner Shaft	47	—	—	—	—	
13	Hub Assembly	48	43355	43355	43355	43355	
14	KIT – Motor Assembly	-	707245X	707245X	707245X	707245X	
15	Motor Assembly	52	43429	43429	43429	43429	
16	Cap Screw	54	500396-9	500396-9	500396-9	500396-9	
17	Cover – Disconnect Housing	56	42208	42208	42208	42208	
18	Switch Assembly	57	44060	44060	44060	44060	
19	Bushing/Bearing	64	43337	43337	43337	43337	
20	Oil Seal	65	42500	42500	42500	42500	
21	Guide – Axle Shaft	66	—	—	—	—	
22	Bushing/Bearing	67	43342	43342	43342	43342	
23	Shaft – Output	68	43361-1	43361-1	43361-1	43361-1	
24	Spring – Wave Washer	71	45749	—	45749	45749	

Jeep / Eagle 1980-1987 1/2

**Model 30 /181 IFS
Front Axles for**

Eagle

Jeep 30 /181 IFS Front Axles Exploded View

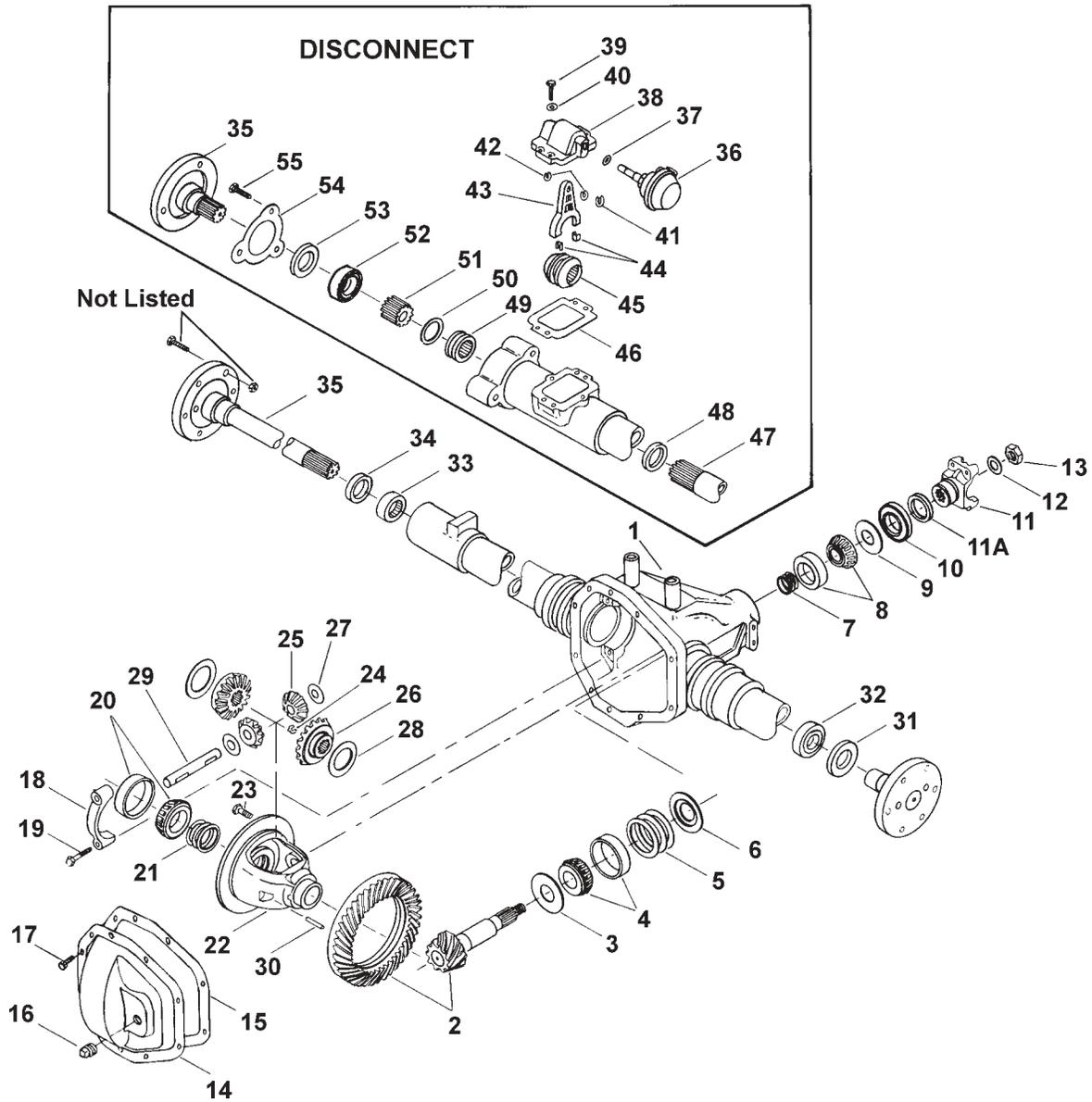

Jeep 30 /181 IFS Front Axles Parts Listing



ITEM NO.	PART NUMBER	DESCRIPTION	ITEM NO.	PART NUMBER	DESCRIPTION
1	— ⁽³⁾	Housing – Axle Service	28	40027	Thrustwasher – Differential Gear
2	— ⁽¹⁾	Drive Pinion & Gear Assembly	29	32915	Shaft – Differential
3	30764	Slinger – Inner Pinion	30	13449	Lock – Differential Shaft
	700132	PKG – Pinion Bearing Shim (inc items 5, 7, 12, 13, 15, 24)	31	— ⁽²⁾	Oil Seal
	700134	PKG – Diff & Pinion Bearing Shim (inc items 5, 7, 12, 13, 15, 21, 24)	32	— ⁽²⁾	Bearing
4	706015X	KIT – Inner Pinion Bearing	33	620492	Bearing
5	—	Inner Pinion Bearing Shims (see shim packages)	34	620493	Oil Seal
6	32349	Baffle – Pinion Bearing	35	— ⁽¹⁾	Axle Shaft
7	—	Outer Pinion Bearing Shims (see shim packages)		706826X	KIT – Vacuum Motor (inc items 36,37,39,40,41,42,44,46)
8	706030X	KIT – Outer Pinion Bearing		706825X	KIT – Shift Fork (inc items 37,39,40,42,43,44,46)
9	13575	Slinger – Outer Pinion Bearing		706824X	KIT – Shift Clip (inc items 39,40,44,46)
10	39118	Seal – Pinion Oil	36	621070	Motor Assembly
11	2-4-8091-1X	End Yoke Assembly (inc 11A)	37	620980	O-Ring
11A	41498	Slinger – End Yoke	38	621064	Cover – Disconnect Housing
12	30186	Washer – Pinion Nut	39	500396-9	Cap Screw
13	30185	Pinion Nut	40	500357-9	Lockwasher
	706867X	KIT – Carrier Cover (inc 14-17)	41	621097	Snap Ring
14	32538	Carrier Cover	42	620979	Snap Ring
15	34684	Gasket – Carrier Cover	43	621067	Shift Fork
16	36472	Plug – Carrier Cover	44	621059	Clips – Shift Fork
17	34279	Bolt – Carrier Cover (qty 10)	45	620973	Clutch Collar
18	— ⁽³⁾	Differential Bearing Cap	46	41494	Gasket
19	48631-1	Bolt – Differential Bearing Cap	47	40368	Shaft – Output
20	706016X	KIT – Differential Bearing	48	621000	Bearing
21	700133	KIT – Diff Bearing Shim (inc 15, 24)	49	620971	Bearing
22	— ⁽⁴⁾	Case – Differential (std)	50	40081	Snap Ring
23	30187	Bolt – Drive Gear (qty 10)	51	620967	Gear – Outer Disconnect
24	42570	Snap Ring	52	565909	Bearing – Unitized
25	32926	Pinion – Differential	53	35938	Oil Seal
26	620486	Gear – Differential	54	620966	Plate – Retaining
27	34096	Thrustwasher – Differential Pinion	55	500501-3	Bolt

- (1) See "Bill of Material Table" on next page
- (2) See "Variable Parts Table" below
- (3) Contact Vehicle Manufacturer
- (4) Not Sold Separately

Variable Parts Listing

Kits & Parts - Use With All Applications									
Description & Item Number (Refer to "Exploded View on previous page")			Bills of Material						
			610078	610134	610152	610153	610173	610174	610235
1	Oil Seal	31	620840	620491	620840	620491	620840	620491	620840
2	Bearing	32	565977	620490	565977	620490	565977	620490	565977

Jeep 30 /181 IFS Front Axles

Bill of Material Table

Axle			Axle Kits				Shaft & Joint Assy.	
Bill of Material	Diff. Type	Ratio	Ring Gear & Pinion Kit ⁽⁷⁾	Differential			Right Hand Shaft Assy.	Left Hand Shaft Assy.
				Case Assy. Kit ⁽⁸⁾	Case Kit	Inner Parts Kit		
1980-81 IFS – Eagle – Non-Disconnect								
610078-1	Standard	3.07	700128-1	706819X	700130	706820X	620515	620516
610078-2	Standard	3.54	700128-6	706819X	700130	706820X	620515	620516
610078-5	Standard	3.07	700128-1	706819X	700130	706820X	620515	620516
610078-6	Standard	3.54	700128-6	706819X	700130	706820X	620515	620516
610078-8	Standard	2.72	700128-2	706819X	700130	706820X	620515	620516
1981 IFS – Eagle – Disconnect								
610134-1	Standard	3.07	700128-1	706819X	700130	706820X	620964	620516
610134-3	Standard	3.31	700128-5	706819X	700130	706820X	620964	620516
610134-5	Standard	3.54	700128-6	706819X	700130	706820X	620964	620516
610134-7	Standard	2.72	700128-2	706819X	700130	706820X	620964	620516
1982-82 1/2 IFS – Eagle – Non-Disconnect								
610152-1	Standard	2.35	700128-7	706819X	700130	706820X	620515	620516
610152-4	Standard	2.72	700128-2	706830X	706831X	706820X	620515	620516
610152-5	Standard	3.54	700128-6	706830X	706831X	706820X	620515	620516
610152-6	Standard	3.07	700128-1	706830X	706831X	706820X	620515	620516
1982-82 1/2 IFS – Eagle – Disconnect								
610153-1	Standard	2.35	700128-7	706819X	700130	706820X	620964	620516
610153-4	Standard	2.72	700128-2	706819X	700130	706820X	620964	620516
610153-5	Standard	3.54	700128-6	706819X	700130	706820X	620964	620516
610153-6	Standard	2.72	700128-1	706819X	700130	706820X	620964	620516
1983-84 IFS – Eagle – Non-Disconnect								
610173-1	Standard	2.35	700128-7	706819X	700130	706820X	620515	620842
610173-4	Standard	2.72	700128-2	706830X	706831X	706820X	620515	620842
610173-5	Standard	3.54	700128-6	706830X	706831X	706820X	620515	620842
610173-6	Standard	3.07	700128-1	706830X	706831X	706820X	620515	620842
1983-84 IFS – Eagle – Disconnect								
610174-1	Standard	2.35	700128-7	706819X	700130	706820X	620964	620842
610174-4	Standard	2.72	700128-2	706830X	706831X	706820X	620964	620842
610174-5	Standard	3.54	700128-6	706830X	706831X	706820X	620964	620842
610174-6	Standard	3.07	700128-1	706830X	706831X	706820X	620964	620842
1985-87 1/2 IFS – Eagle – Non-Disconnect – CV								
610235-1	Standard	2.35	700128-7	706819X	700130	706820X	620515	620842
610235-2	Standard	2.72	700128-2	706830X	706831X	706820X	620515	620842
610235-3	Standard	3.07	700128-1	706830X	706831X	706820X	620515	620842

NOTE: All Ring & Pinion Kits with base number 706930 are reverse spiral bevel

(7) See Ring Gear & Pinion Kits in XGI Catalog for ratio & tooth combinations.

(8) See Differential Case Assy Kits in XGI Catalog for spline data & ratios.

Jeep / Eagle 1992 1/2 -1998 1/2

Model 30 /181

Front Axles with Collapsible Spacer for

TJ (Wrangler)

ZJ (Grand Cherokee)

Jeep Model 30 /181 Front w/Collapsible Spacer Exploded View

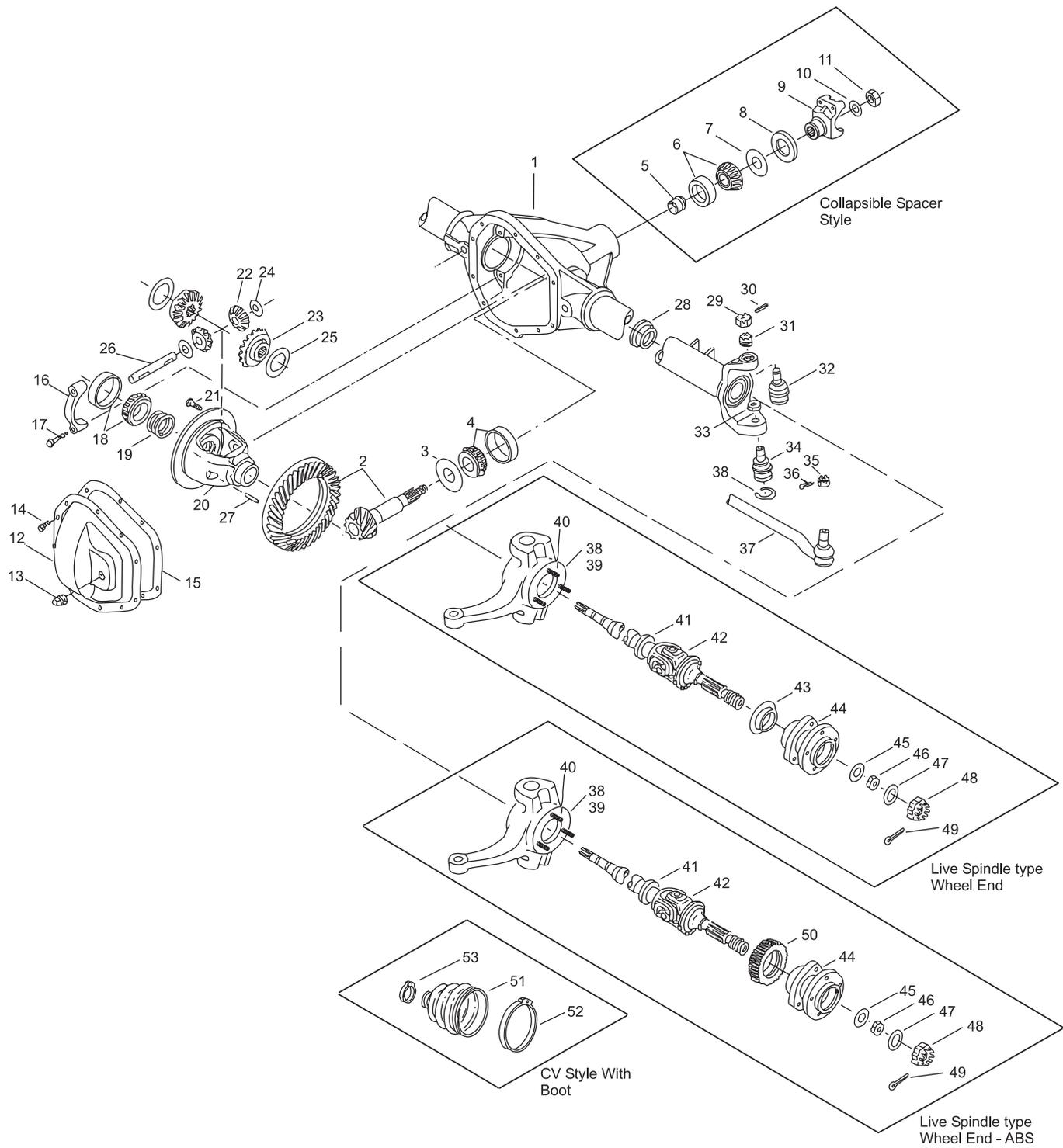

Jeep Model 30 /181 Front w/Collapsible Spacer

Parts Listing

ITEM NO.	PART NUMBER	DESCRIPTION	ITEM NO.	PART NUMBER	DESCRIPTION
1	— ⁽³⁾	Housing – Axle Service	28	46470	Oil Seal (tube seal)
2	— ⁽¹⁾	Drive Pinion & Gear Assembly		706944X	KIT – Socket Assembly (inc items 29, 30, 31, 32, 33, 34)
3	49634	Slinger – Inner Pinion Bearing			
4	706015X	KIT – Inner Pinion Bearing	29	43682	Nut – Slotted
5	— ⁽²⁾	Collapsible Spacer	30	500024-6	Cotter Pin
6	706894X	KIT – Outer Pinion Bearing	31	40586	Adjusting Split Ring
7	13575	Slinger – Outer Pinion Bearing	32	40583	Socket Assembly (lower)
8	— ⁽²⁾	Seal – Pinion Oil	33	40584	Nut – Hex Jam
9	— ⁽²⁾	End Yoke or Companion Flange	34	40916	Socket Assembly (upper)
10	30186	Washer – Pinion Nut	35	— ⁽³⁾	Nut – Hex Slotted
11	30185	Pinion Nut	36	— ⁽³⁾	Cotter Pin
	— ⁽²⁾	Carrier Cover Assembly (inc 12, 13)	37	— ⁽⁵⁾	Tie Rod Assembly
	— ⁽²⁾	KIT – Carrier Cover (inc items 12, 13, 14)	38	— ⁽³⁾	Right – Knuckle
12	40869-1	Carrier Cover	39	— ⁽³⁾	Left – Knuckle
13	— ⁽²⁾	Plug – Carrier Cover	40	41027	Bolt – Knuckle
14	34279	Bolt – Carrier Cover (qty 10)	41	— ⁽²⁾	Slinger – Dust
15	38615	RTV Silicone Sealant	42	— ⁽¹⁾	Shaft & Joint Assembly
16	— ⁽³⁾	Differential Bearing Cap	43	— ⁽²⁾	Slinger – Hub Oil
17	48631-1	Bolt – Differential Bearing Cap	44	— ⁽²⁾	Hub Assembly
18	706016X	KIT – Differential Bearing	45	40596	Washer – Flat
19	701004X	PKG – Differential Bearing Shim	46	40597	Nut – Hex
20	— ⁽¹⁾	Case – Differential (std)	47	45749	Washer – Spring Wave
21	41221	Bolt – Drive Gear (qty 10)	48	40598	Retainer Nut
22	32926	Pinion – Differential (std)	49	500025-10	Cotter Pin
23	33213	Gear – Differential (std)	50	— ⁽²⁾	Tone Ring
24	34096	Thrustwasher – Differential Pinion		— ⁽²⁾	Shaft & Ring Assembly
25	40027	Thrustwasher – Differential Gear		— ⁽²⁾	KIT – Boot & Clamp (CV Joint)
26	41648	Shaft – Differential (std)	51	— ⁽⁴⁾	Boot
27	13449	Lock – Differential Shaft	52	— ⁽⁴⁾	Clamp
			53	— ⁽⁴⁾	Clamp

(1) See "Bill of Material Table" on next page

(2) See "Variable Parts Table" within this section

(3) Contact Vehicle Manufacturer

(4) Not Sold Separately

(5) See Spicer Chassis Catalog for part number and additional steering parts

Jeep Model 30 /181 Front w/Collapsible Spacer

Bill of Material Table

Axle			Axle Kits				Shaft & Joint Assy.	
Bill of Material	Diff. Type	Ratio	Ring Gear & Pinion Kit ⁽⁷⁾	Differential			Right Hand Shaft Assy.	Left Hand Shaft Assy.
				Case Assy. Kit ⁽⁸⁾	Case Kit	Inner Parts Kit		
1992 1/2-93 ZJ ABS, CV Joint								
610346-2	Standard	3.07	707300-2X	707158X	706007X	707160X	73918-2X	73918-1X
610346-3	Standard	3.31	707300-3X	707158X	706007X	707160X	73918-2X	73918-1X
610346-4	Standard	3.55	707300-4X	707158X	706007X	707160X	73918-2X	73918-1X
610346-5	Standard	3.73	707300-5X	707159X	706008X	707160X	73918-2X	73918-1X
1992 1/2-93 ZJ ABS								
610377-2	Standard	3.07	707300-2X	707158X	706007X	707160X	75815-2X	75815-1X
610377-3	Standard	3.31	707300-3X	707158X	706007X	707160X	75815-2X	75815-1X
610377-4	Standard	3.55	707300-4X	707158X	706007X	707160X	75815-2X	75815-1X
610377-5	Standard	3.73	707300-5X	707159X	706008X	707160X	75815-2X	75815-1X
1993 ZJ (Dead Front), ABS								
610400	-	-	-	-	-	-	-	-
1993 ZJ ABS, CV Joint								
610438-4	Standard	3.55	707300-4X	707158X	706007X	707160X	73918-2X	73918-1X
610438-5	Standard	3.73	707300-5X	707159X	706008X	707160X	73918-2X	73918-1X
1993 1/2 ZJ ABS								
610449-4	Standard	3.55	707300-4X	707158X	706007X	707160X	73918-2X	73918-1X
610449-5	Standard	3.73	707300-5X	707159X	706008X	707160X	73918-2X	73918-1X
610450-4	Standard	3.55	707300-4X	707158X	706007X	707160X	75815-2X	75815-1X
610450-5	Standard	3.73	707300-5X	707159X	706008X	707160X	75815-2X	75815-1X
610451-4	Standard	3.55	707300-4X	707158X	706007X	707160X	73918-2X	73918-1X
610451-5	Standard	3.73	707300-5X	707159X	706008X	707160X	73918-2X	73918-1X
1993 1/2 ZJ (Dead Front), ABS								
610452	-	-	-	-	-	-	-	-
1994 ZJ (Dead Front), ABS								
610465	-	-	-	-	-	-	-	-
1994-94 1/2 ZJ ABS								
610474-4	Standard	3.55	707300-4X	707158X	706007X	707160X	73918-2X	73918-1X
610474-5	Standard	3.73	707300-5X	707159X	706008X	707160X	73918-2X	73918-1X
1994-96 ZJ ABS								
610473-4	Standard	3.55	707300-4X	707158X	706007X	707160X	75815-2X	75815-1X
610473-5	Standard	3.73	707300-5X	707159X	706008X	707160X	75815-2X	75815-1X
610478-4	Standard	3.55	707300-4X	707158X	706007X	707160X	73918-2X	73918-1X
610478-5	Standard	3.73	707300-5X	707159X	706008X	707160X	73918-2X	73918-1X
1994-97 ZJ (Dead Front), ABS								
610475	-	-	-	-	-	-	-	-
1996 1/2-97 1/2 ZJ ABS								
610572-1	Standard	3.55	707344-10X	707158X	706007X	707160X	73918-2X	73918-1X
610572-2	Standard	3.73	707344-11X	707159X	706008X	707160X	73918-2X	73918-1X
610573-1	Standard	3.55	707344-10X	707158X	706007X	707160X	75815-2X	75815-1X
610573-2	Standard	3.73	707344-11X	707159X	706008X	707160X	75815-2X	75815-1X

NOTE: All Ring & Pinion Kits with base number 706930 are reverse spiral bevel

(7) See Ring Gear & Pinion Kits in XGI Catalog for ratio & tooth combinations.

(8) See Differential Case Assy Kits in XGI Catalog for spline data & ratios.

Jeep Model 30 /181 Front w/Collapsible Spacer

Bill of Material Table

Axle			Axle Kits				Shaft & Joint Assy.	
Bill of Material	Diff. Type	Ratio	Ring Gear & Pinion Kit ⁽⁷⁾	Differential			Right Hand Shaft Assy.	Left Hand Shaft Assy.
				Case Assy. Kit ⁽⁸⁾	Case Kit	Inner Parts Kit		
1997 TJ RHD								
610489-1	Standard	3.07	707344-2X	707158X	706007X	707160X	75814-2X	75814-1X
610489-2	Standard	3.55	707344-10X	707158X	706007X	707160X	75814-2X	75814-1X
610489-3	Standard	4.10	707344-6X	707159X	706008X	707160X	75814-2X	75814-1X
610489-4	Standard	3.73	707344-11X	707159X	706008X	707160X	75814-2X	75814-1X
610489-6	Standard	3.07	707344-2X	707158X	706007X	707160X	75814-2X	75814-1X
610489-7	Standard	3.55	707344-10X	707158X	706007X	707160X	75814-2X	75814-1X
610489-8	Standard	4.10	707344-6X	707159X	706008X	707160X	75814-2X	75814-1X
610489-9	Standard	3.73	707344-11X	707159X	706008X	707160X	75814-2X	75814-1X
1997 TJ ABS								
610629-1	Standard	3.07	707344-2X	707158X	706007X	707160X	75815-2X	75815-1X
610629-2	Standard	3.55	707344-10X	707158X	706007X	707160X	75815-2X	75815-1X
1997 TJ								
610630-1	Standard	3.07	707344-2X	707158X	706007X	707160X	75814-2X	75814-1X
610630-2	Standard	3.55	707344-10X	707158X	706007X	707160X	75814-2X	75814-1X
610630-3	Standard	4.10	707344-6X	707159X	706008X	707160X	75814-2X	75814-1X
610630-4	Standard	3.73	707344-11X	707159X	706008X	707160X	75814-2X	75814-1X
1997-97 1/2 ZJ ABS								
610663-1	Standard	3.55	707344-10X	707158X	706007X	707160X	75815-2X	75815-1X
610663-2	Standard	3.73	707344-11X	707159X	706008X	707160X	75815-2X	75815-1X
610664-1	Standard	3.55	707344-10X	707158X	706007X	707160X	73918-2X	73918-1X
610664-2	Standard	3.73	707344-11X	707159X	706008X	707160X	73918-2X	73918-1X
1997-97 1/2 ZJ (Dead Front), ABS								
610665	-	-	-	-	-	-	-	-
1997 1/2 TJ RHD								
610680-6	Standard	3.07	707344-2X	707158X	706933X	707160X	75814-2X	75814-1X
1997 1/2 TJ ABS								
610681-1	Standard	3.07	707344-2X	707158X	706007X	707160X	75815-2X	75815-1X
610681-2	Standard	3.55	707344-10X	707158X	706007X	707160X	75815-2X	75815-1X
610681-3	Standard	3.73	707344-11X	707159X	706008X	707160X	75815-2X	75815-1X
1997 1/2 TJ								
610682-1	Standard	3.07	707344-2X	707158X	706007X	707160X	75814-2X	75814-1X
610682-2	Standard	3.55	707344-10X	707158X	706007X	707160X	75814-2X	75814-1X
610682-3	Standard	4.10	707344-6X	707159X	706008X	707160X	75814-2X	75814-1X
610682-4	Standard	3.73	707344-11X	707159X	706008X	707160X	75814-2X	75814-1X
1998-98 1/2 ZJ ABS								
610748-1	Standard	3.55	707344-10X	707158X	706007X	707160X	75815-2X	75815-1X
610748-2	Standard	3.73	707344-11X	707159X	706008X	707160X	75815-2X	75815-1X
610752-1	Standard	3.55	707344-10X	707158X	706007X	707160X	75815-2X	75815-1X
610752-2	Standard	3.73	707344-11X	707159X	706008X	707160X	75815-2X	75815-1X
1998-98 1/2 ZJ ABS, CV Joint								
610749-1	Standard	3.55	707344-10X	707158X	706007X	707160X	73918-2X	73918-1X
610749-2	Standard	3.73	707344-11X	707159X	706008X	707160X	73918-2X	73918-1X
610751-1	Standard	3.55	707344-10X	707158X	706007X	707160X	73918-2X	73918-1X
610751-2	Standard	3.73	707344-11X	707159X	706008X	707160X	73918-2X	73918-1X

NOTE: All Ring & Pinion Kits with base number 706930 are reverse spiral bevel

(7) See Ring Gear & Pinion Kits in XGI Catalog for ratio & tooth combinations.

(8) See Differential Case Assy Kits in XGI Catalog for spline data & ratios.

Jeep Model 30 /181 Front w/Collapsible Spacer

Bill of Material Table

Axle			Axle Kits				Shaft & Joint Assy.	
Bill of Material	Diff. Type	Ratio	Ring Gear & Pinion Kit ⁽⁷⁾	Differential			Right Hand Shaft Assy.	Left Hand Shaft Assy.
				Case Assy. Kit ⁽⁸⁾	Case Kit	Inner Parts Kit		
1998-98 1/2 ZJ (Dead Front), ABS								
610750	-	-	-	-	-	-	-	-
1998-98 1/2 TJ								
610755-1	Standard	3.07	707344-2X	707158X	706007X	707160X	75814-2X	75814-1X
610755-2	Standard	3.55	707344-10X	707158X	706007X	707160X	75814-2X	75814-1X
610755-3	Standard	4.10	707344-6X	707159X	706008X	707160X	75814-2X	75814-1X
610755-4	Standard	3.73	707344-11X	707159X	706008X	707160X	75814-2X	75814-1X
1998-98 1/2 TJ ABS								
610756-1	Standard	3.07	707344-2X	707158X	706007X	707160X	75815-2X	75815-1X
610756-2	Standard	3.55	707344-10X	707158X	706007X	707160X	75815-2X	75815-1X
610756-3	Standard	3.73	707344-11X	707159X	706008X	707160X	75815-2X	75815-1X
1998-98 1/2 TJ RHD								
610757-1	Standard	3.07	707344-2X	707158X	706007X	707160X	75814-2X	75814-1X
610757-2	Standard	4.10	707344-6X	707159X	706008X	707160X	75814-2X	75814-1X
610757-3	Standard	3.73	707344-11X	707159X	706008X	707160X	75814-2X	75814-1X

NOTE: All Ring & Pinion Kits with base number 706930 are reverse spiral bevel
 (7) See Ring Gear & Pinion Kits in XGI Catalog for ratio & tooth combinations.
 (8) See Differential Case Assy Kits in XGI Catalog for spline data & ratios.

Jeep Model 30 /181 Front w/Collapsible Spacer

Variable Parts Listing

Kits & Parts - Use With All Applications							
Description & Item Number (Refer to "Exploded View" at the front of this section)			Bills of Material				
			610346	610377	610400	610438 610449	610450
1	Collapsible Spacer	5	44228	44228	—	44228	44228
2	Seal – Pinion Oil	8	39118	39118	39118	39118	39118
3	End Yoke or Companion Flange	9	2-4-6561-1	2-4-6561-1	—	2-4-6561-1	2-4-6561-1
4	Carrier Cover Assembly (inc 12, 13)	-	—	—	—	—	—
5	KIT – Carrier Cover	-	707274X	707274X	707274X	707274X	707274X
6	Plug – Carrier Cover	13	43180	43180	43180	43180	43180
7	Slinger – Dust	41	—	—	—	—	46849
8	Slinger – Hub Oil	43	—	—	—	—	—
9	Hub Assembly	44	43355	43355	43355	43355	43355
10	Tone Ring	50	44646	44646	44646	44646	44646
11	Shaft & Ring Assembly	-	—	—	—	—	—
12	KIT – Boot & Clamp (CV Joint)	-	75528X	—	—	75528X	75528X
			610451	610452 610465	610473	610474	610475
1	Collapsible Spacer	5	44228	—	44228	44228	—
2	Seal – Pinion Oil	8	39118	39118	39118	39118	39118
3	End Yoke or Companion Flange	9	2-4-6561-1	—	2-4-6561-1	2-4-6561-1	—
4	Carrier Cover Assembly (inc 12, 13)	-	—	—	—	—	—
5	KIT – Carrier Cover	-	707274X	707274X	707274X	707274X	707274X
6	Plug – Carrier Cover	13	43180	43180	43180	43180	43180
7	Slinger – Dust	41	—	—	46849	—	—
8	Slinger – Hub Oil	43	—	—	—	—	—
9	Hub Assembly	44	43355	43355	43355	43355	43355
10	Tone Ring	50	44646	44646	44646	44646	44646
11	Shaft & Ring Assembly	-	—	—	—	—	—
12	KIT – Boot & Clamp (CV Joint)	-	75528X	—	—	75528X	—
			610478	610489	610572	610573 610629	610630
1	Collapsible Spacer	5	44228	46194	46194	46194	46194
2	Seal – Pinion Oil	8	39118	39118	39118	39118	39118
3	End Yoke or Companion Flange	9	2-1-2791	2-4-6561-1	2-1-2791	2-4-6561-1	2-4-6561-1
4	Carrier Cover Assembly (inc 12, 13)	-	—	—	—	—	—
5	KIT – Carrier Cover	-	707274X	707274X	707274X	707274X	707274X
6	Plug – Carrier Cover	13	43180	43180	43180	43180	43180
7	Slinger – Dust	41	—	46849	—	46849	46849
8	Slinger – Hub Oil	43	—	40589	—	—	40589
9	Hub Assembly	44	43355	43355	43355	43355	43355
10	Tone Ring	50	44646	—	44646	44646	—
11	Shaft & Ring Assembly	-	—	—	—	—	—
12	KIT – Boot & Clamp (CV Joint)	-	75528X	—	75528X	—	—

Jeep Model 30 /181 Front w/Collapsible Spacer Variable Parts Listing

Kits & Parts - Use With All Applications							
Description & Item Number (Refer to "Exploded View" at the front of this section)			Bills of Material				
			610663	610664	610665	610680	610681
1	Collapsible Spacer	5	46194	46194	—	46194	46194
2	Seal – Pinion Oil	8	39118	39118	39118	44895	44895
3	End Yoke or Companion Flange	9	2-4-6561-1	2-1-2791	—	2-4-6561-1	2-4-6561-1
4	Carrier Cover Assembly (inc 12, 13)	-	—	—	—	—	—
5	KIT – Carrier Cover	-	707274X	707274X	707274X	707274X	707274X
6	Plug – Carrier Cover	13	43180	43180	43180	43180	43180
7	Slinger – Dust	41	46849	—	—	46849	46849
8	Slinger – Hub Oil	43	—	—	—	46988	—
9	Hub Assembly	44	43355	43355	43355	43355	43355
10	Tone Ring	50	44646	44646	44646	—	—
11	Shaft & Ring Assembly	-	—	—	—	—	75007X
12	KIT – Boot & Clamp (CV Joint)	-	—	75528X	—	—	—
			610682	610748	610749	610750	610751
1	Collapsible Spacer	5	46194	46194	46194	—	46194
2	Seal – Pinion Oil	8	44895	44895	44895	—	44895
3	End Yoke or Companion Flange	9	2-4-6561-1	2-4-6561-1	2-1-2791	—	2-1-2791
4	Carrier Cover Assembly (inc 12, 13)	-	—	80194	80194	—	80194
5	KIT – Carrier Cover	-	707274X	—	—	—	—
6	Plug – Carrier Cover	13	43180	43181	43181	—	43181
7	Slinger – Dust	41	46849	46849	—	—	—
8	Slinger – Hub Oil	43	46988	—	—	—	—
9	Hub Assembly	44	43355	43355	43355	43355	43355
10	Tone Ring	50	—	44646	44646	44646	44646
11	Shaft & Ring Assembly	-	—	—	—	—	—
12	KIT – Boot & Clamp (CV Joint)	-	—	—	75528X	—	75528X
			610752	610755	610756	610757	
1	Collapsible Spacer	5	46194	46194	46194	46194	
2	Seal – Pinion Oil	8	44895	44895	44895	44895	
3	End Yoke or Companion Flange	9	2-4-6561-1	2-4-6561-1	2-4-6561-1	2-4-6561-1	
4	Carrier Cover Assembly (inc 12, 13)	-	80194	707274X	707274X	707274X	
5	KIT – Carrier Cover	-	—	—	—	—	
6	Plug – Carrier Cover	13	43181	43180	43180	43180	
7	Slinger – Dust	41	46849	46849	46849	46849	
8	Slinger – Hub Oil	43	—	46988	—	46988	
9	Hub Assembly	44	43355	49773	49773	49773	
10	Tone Ring	50	44646	—	44646	—	
11	Shaft & Ring Assembly	-	75007X	—	75007X	—	
12	KIT – Boot & Clamp (CV Joint)	-	—	—	—	—	

Jeep / Eagle 1978-1992

**Model 44 /216
Front Axles for**

**4 x 2, Military,
J10, J20,
Cherokee,
Honcho,
Wagoneer,
Grand Wagoneer**

Jeep Model 44 /216 Front Axles Exploded View

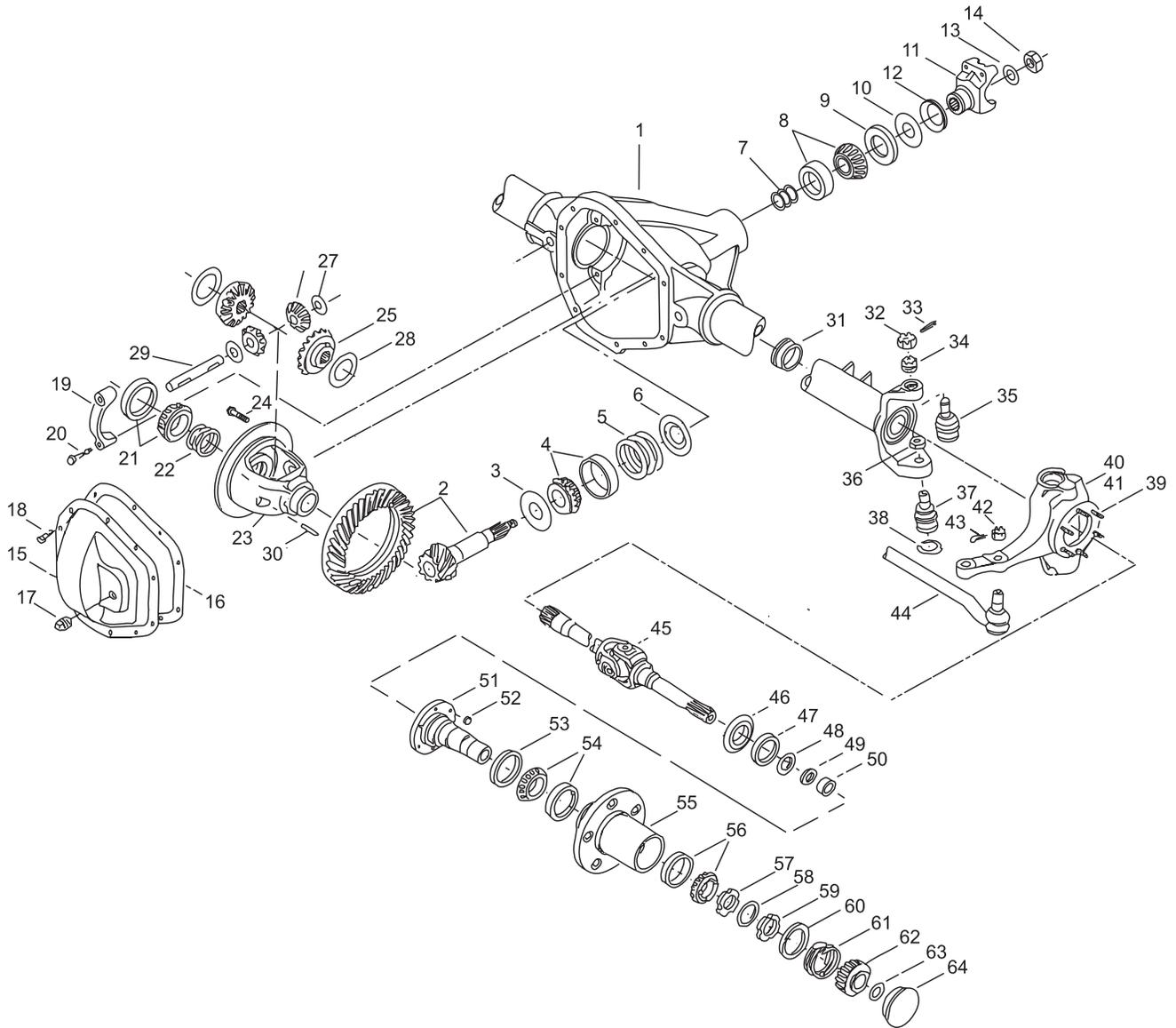

Jeep Model 44 /216 Front Axles

Parts Listing

ITEM NO.	PART NUMBER	DESCRIPTION	ITEM NO.	PART NUMBER	DESCRIPTION
1	— ⁽³⁾	Housing – Axle Service		706576X	KIT – Left Knuckle Assy (inc 32,33,34,35,36,37,38,39,41)
2	— ⁽¹⁾	Drive Pinion & Gear Assembly			
3	30764	Slinger – Inner Pinion Bearing		706116X	KIT – Socket Assembly (inc 32,33,34,35,36,37,38)
4	706031X	KIT – Inner Pinion Bearing			
	706376X	PKG – Diff & Pinion Bearing Shim (inc items 5, 7, 12, 13, 16, 22)	32	44101	Nut – Hex Slotted
	706358X	PKG – Pinion Bearing Shim (inc items 5, 7, 12, 13, 16)	33	500024-6	Cotter Pin
			34	35417	Adjusting Split Ring
5	—	Inner Pinion Bearing Shims (see shim packages)	35	40112	Socket Assembly
			36	35566	Nut – Hex Jam
6	30765	Baffle – Pinion Bearing	37	40113	Socket Assembly
7	—	Outer Pinion Bearing Shims (see shim packages)	38	35928	Snap Ring
			39	36326-2	Bolt – Hex (qty 6)
8	706030X	KIT – Outer Pinion Bearing	40	38532	Right Knuckle
9	13575	Slinger – Outer Pinion Bearing	41	38534	Left Knuckle
10	39118	Seal – Pinion Oil	42	— ⁽³⁾	Nut – Hex Slotted
11	— ⁽²⁾	End Yoke or Assembly (inc 12)	43	— ⁽³⁾	Cotter Pin
12	— ⁽²⁾	Slinger – End Yoke	44	— ⁽⁵⁾	Tie Rod Assembly
13	30186	Washer – Pinion Nut	45	— ⁽¹⁾	Shaft & Joint Assembly
14	30185	Pinion Nut	46	36364	Slinger – Spindle Yoke
	706141X	KIT – Carrier Cover (inc items 15, 16, 17, 18)		706527X	KIT – Spindle Seal & Bearing (inc items 47, 48, 49, 50)
15	39015	Carrier Cover		706570X	KIT – Spindle (inc items 47, 48, 49, 50, 51)
16	34685	Gasket – Carrier Cover	47	38128	Oil Seal
17	36918	Plug – Carrier Cover	48	36361	Oil Seal (block vee)
18	34279	Bolt – Carrier Cover	49	38106	Spacer – Wheel Bearing Spindle
19	— ⁽³⁾	Differential Bearing Cap	50	550759	Bearing Assembly – Needle
20	48632-1	Bolt – Differential Bearing Cap	51	38428	Spindle – Wheel Bearing
21	706032X	KIT – Differential Bearing	52	— ⁽³⁾	Nut – Brake Mounting
22	706086X	PKG – Diff Bearing Shim (inc 16)	53	36366	Oil Seal
23	— ⁽⁴⁾	Case – Differential (std)	54	706074X	KIT – Inner Wheel Bearing
24	30187	Bolt – Drive Gear (qty 10)	55	— ⁽³⁾	Wheel Hub
25	31487	Gear – Differential (std)	56	706111X	KIT – Outer Wheel Bearing
26	17717	Pinion – Differential (std)	57	21588X	Nut & Pin Assembly – Inner Lock
27	13338-3	Thrustwasher – Diff Pinion (std)	58	36569	Lock Nut
28	32121	Thrustwasher – Diff Gear (std)	59	31139	Nut – Wheel Bearing Adjusting
29	39194	Shaft – Differential (std)	60	32589	Plate – Spring Retaining
30	13449	Lock – Differential Shaft	61	35218	Spring – Pressure
31	— ⁽²⁾	Seal & Guide Tube	62	42667	Gear – Axle Drive
	706575X	KIT – Right Knuckle Assembly (inc 32,33,34,35,36,37,38,39,40)	63	31624	Snap Ring
			64	36858	Hub Cap

(1) See "Bill of Material Table" on next page

(2) See "Variable Parts Table" within this section

(3) Contact Vehicle Manufacturer

(4) Not Sold Separately

(5) See Spicer Chassis Catalog for part number and additional steering parts

Jeep Model 44 /216 Front Axles

Bill of Material Table

Axle			Axle Kits				Shaft & Joint Assy.	
Bill of Material	Diff. Type	Ratio	Ring Gear & Pinion Kit ⁽⁷⁾	Differential			Right Hand Shaft Assy.	Left Hand Shaft Assy.
				Case Assy. Kit ⁽⁸⁾	Case Kit	Inner Parts Kit		
1978-79 Wagoneer / Cherokee								
603683-3	Standard	4.09	706017-5X	706021X	706025X	706027X	660091-3	660091-4
603683-5	Standard	3.07	706017-1X	706020X	706024X	706027X	660091-3	660091-4
603683-6	Standard	3.54	706017-3X	706020X	706024X	706027X	660091-3	660091-4
603683-7	Standard	2.72	706017-19X	706020X	706024X	706027X	660091-3	660091-4
1978-79 J10, J20, Honcho, Cherokee Wide Track								
603685-1	Standard	4.09	706017-5X	706021X	706025X	706027X	660091-5	660091-6
603685-2	Standard	4.89	706017-7X	706021X	706025X	706027X	660091-5	660091-6
603685-5	Standard	3.73	706017-4X	706020X	706024X	706027X	660091-5	660091-6
603685-6	Standard	3.54	706017-3X	706020X	706024X	706027X	660091-5	660091-6
603685-7	Standard	3.07	706017-1X	706020X	706024X	706027X	660091-5	660091-6
1980 J10, J20, Wide Track Cherokee								
610089-1	Standard	4.09	706017-5X	706021X	706025X	706027X	660091-23	660091-22
610089-2	Standard	4.89	706017-7X	706021X	706025X	706027X	660091-23	660091-22
610089-3	Standard	3.31	706017-2X	706020X	706024X	706027X	660091-23	660091-22
610089-5	Standard	3.73	706017-4X	706020X	706024X	706027X	660091-23	660091-22
610089-6	Standard	3.54	706017-3X	706020X	706024X	706027X	660091-23	660091-22
610089-8	Standard	2.72	706017-19X	706020X	706024X	706027X	660091-23	660091-22
1980 Wagoneer / Cherokee								
610090-1	Standard	3.73	706017-4X	706020X	706024X	706027X	660091-9	660091-24
610090-2	Standard	3.31	706017-2X	706020X	706024X	706027X	660091-9	660091-24
610090-3	Standard	4.09	706017-5X	706021X	706025X	706027X	660091-9	660091-24
610090-7	Standard	2.72	706017-19X	706020X	706024X	706027X	660091-9	660091-24
1981-85 J10, J20, Wide Track Cherokee								
610139-1	Standard	4.09	706017-5X	706021X	706025X	706027X	660091-23	660091-22
610139-2	Standard	4.89	706017-7X	706021X	706025X	706027X	660091-23	660091-22
610139-3	Standard	3.31	706017-2X	706020X	706024X	706027X	660091-23	660091-22
610139-5	Standard	3.73	706017-4X	706020X	706024X	706027X	660091-23	660091-22
610139-6	Standard	3.54	706017-3X	706020X	706024X	706027X	660091-23	660091-22
610139-8	Standard	2.72	706017-19X	706020X	706024X	706027X	660091-23	660091-22
1981-85 Wagoneer / Cherokee								
610140-1	Standard	3.73	706017-4X	706020X	706024X	706027X	660091-9	660091-24
610140-2	Standard	3.31	706017-2X	706020X	706024X	706027X	660091-9	660091-24
610140-3	Standard	4.09	706017-5X	706021X	706025X	706027X	660091-9	660091-24
610140-4	Standard	4.89	706017-7X	706021X	706025X	706027X	660091-9	660091-24
610140-7	Standard	2.72	706017-19X	706020X	706024X	706027X	660091-9	660091-24
610140-9	Standard	3.73	706017-4X	706020X	706024X	706027X	660091-9	660091-24
610140-10	Standard	4.89	706017-7X	706021X	706025X	706027X	660091-9	660091-24
610140-11	Standard	4.09	706017-5X	706021X	706025X	706027X	660091-9	660091-24
1985 Grand Wagoneer								
610227-1	Standard	2.72	706017-19X	706020X	706024X	706027X	660091-9	660091-24
610227-2	Standard	3.31	706017-2X	706020X	706024X	706027X	660091-9	660091-24
1985 4X2, Military - Dead Front								
610228	-	-	-	-	-	-	-	-

NOTE: All Ring & Pinion Kits with base number 706930 are reverse spiral bevel
 (7) See Ring Gear & Pinion Kits in XGI Catalog for ratio & tooth combinations.
 (8) See Differential Case Assy Kits in XGI Catalog for spline data & ratios.

Jeep Model 44 /216 Front Axles

Bill of Material Table

Axle			Axle Kits				Shaft & Joint Assy.	
Bill of Material	Diff. Type	Ratio	Ring Gear & Pinion Kit ⁽⁷⁾	Differential			Right Hand Shaft Assy.	Left Hand Shaft Assy.
				Case Assy. Kit ⁽⁸⁾	Case Kit	Inner Parts Kit		
1986 J10								
610246-3	Standard	3.31	706017-2X	706020X	706024X	706027X	660091-23	660091-22
610246-8	Standard	2.72	706017-19X	706020X	706024X	706027X	660091-23	660091-22
610246-12	Standard	3.31	706017-2X	706020X	706024X	706027X	660091-23	660091-22
610246-17	Standard	2.72	706017-19X	706020X	706024X	706027X	660091-23	660091-22
1986 Grand Wagoneer								
610247-1	Standard	2.72	706017-19X	706020X	706024X	706027X	660091-9	660091-24
610247-2	Standard	3.31	706017-2X	706020X	706024X	706027X	660091-9	660091-24
610247-3	Standard	2.72	706017-19X	706020X	706024X	706027X	660091-9	660091-24
610247-4	Standard	3.31	706017-2X	706020X	706024X	706027X	660091-9	660091-24
1986 J20								
610248-2	Standard	4.89	706017-7X	706021X	706025X	706027X	660091-23	660091-22
610248-3	Standard	3.31	706017-2X	706020X	706024X	706027X	660091-23	660091-22
610248-5	Standard	3.73	706017-4X	706020X	706024X	706027X	660091-23	660091-22
610248-11	Standard	4.89	706017-7X	706021X	706025X	706027X	660091-23	660091-22
610248-12	Standard	3.31	706017-2X	706020X	706024X	706027X	660091-23	660091-22
610248-14	Standard	3.73	706017-4X	706020X	706024X	706027X	660091-23	660091-22
1987-87 1/2 J10								
610284-1	Standard	3.31	706017-2X	706020X	706024X	706027X	660091-23	660091-22
610284-2	Standard	2.72	706017-19X	706020X	706024X	706027X	660091-23	660091-22
610284-3	Standard	3.31	706017-2X	706020X	706024X	706027X	660091-23	660091-22
610284-4	Standard	2.72	706017-19X	706020X	706024X	706027X	660091-23	660091-22
1987-87 1/2 J20								
610285-1	Standard	4.89	706017-7X	706021X	706025X	706027X	660091-23	660091-22
610285-2	Standard	3.31	706017-2X	706020X	706024X	706027X	660091-23	660091-22
610285-3	Standard	3.73	706017-4X	706020X	706024X	706027X	660091-23	660091-22
610285-4	Standard	4.89	706017-7X	706021X	706025X	706027X	660091-23	660091-22
610285-5	Standard	3.31	706017-2X	706020X	706024X	706027X	660091-23	660091-22
610285-6	Standard	3.73	706017-4X	706020X	706024X	706027X	660091-23	660091-22
1987-88 Grand Wagoneer								
610283-1	Standard	2.72	706017-19X	706020X	706024X	706027X	660091-9	660091-24
610283-2	Standard	3.31	706017-2X	706020X	706024X	706027X	660091-9	660091-24
610283-3	Standard	2.72	706017-19X	706020X	706024X	706027X	660091-9	660091-24
610283-4	Standard	3.31	706017-2X	706020X	706024X	706027X	660091-9	660091-24
1988 1/2-92 Grand Wagoneer								
610325-1	Standard	2.72	706017-19X	706020X	706024X	706027X	660091-9	660091-24
610325-2	Standard	3.31	706017-2X	706020X	706024X	706027X	660091-9	660091-24
610325-3	Standard	2.72	706017-19X	706020X	706024X	706027X	660091-9	660091-24
610325-4	Standard	3.31	706017-2X	706020X	706024X	706027X	660091-9	660091-24

NOTE: All Ring & Pinion Kits with base number 706930 are reverse spiral bevel

(7) See Ring Gear & Pinion Kits in XGI Catalog for ratio & tooth combinations.

(8) See Differential Case Assy Kits in XGI Catalog for spline data & ratios.

Jeep Model 44 /216 Front Axles Variable Parts Listing

Kits & Parts - Use With All Applications							
Description & Item Number (Refer to "Exploded View" at the front of this section)			Bills of Material				
			603683	603685 610089	610090	610139	610140 610227
1	End Yoke or Assembly (inc 12)	11	2-4-8091X	2-4-8091X	2-4-8091X	2-4-8091X	2-4-8091X
2	Slinger – End Yoke	12	41498	41498	41498	41498	41498
3	Seal & Guide Tube	31	620257	620216	620257	620216	620257
			610228	610246	610247	610248	610283
1	End Yoke or Assembly (inc 12)	11	—	2-4-8091-1X	2-4-8091-1X	2-4-8091-1X	2-4-6781-1
2	Slinger – End Yoke	12	—	41498	41498	41498	—
3	Seal & Guide Tube	31	—	620216	620257	620216	620257
			610284 610285	610325			
1	End Yoke or Assembly (inc 12)	11	2-4-6781-1	2-4-6781-1			
2	Slinger – End Yoke	12	—	—			
3	Seal & Guide Tube	31	620216	620257			

Jeep / Eagle 1982-1984

**Model 44 /216 Disconnect
Front Axles for**

**J10, J20,
Cherokee,
Wagoneer**

Jeep 44 /216 Disconnect Front Axles Exploded View

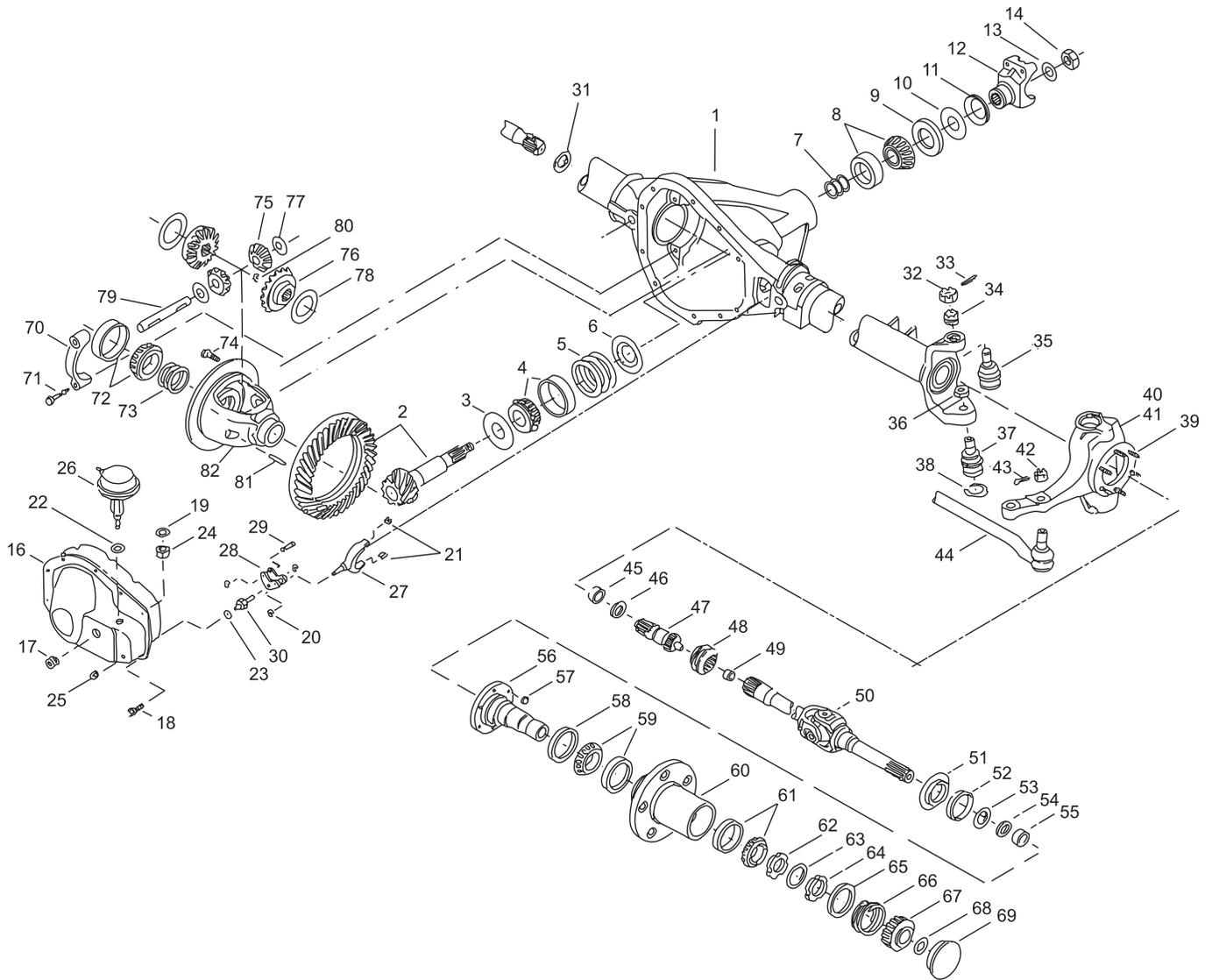

Jeep 44 /216 Disconnect Front Axles Parts Listing

ITEM NO.	PART NUMBER	DESCRIPTION	ITEM NO.	PART NUMBER	DESCRIPTION
1	— ⁽³⁾	Housing – Axle Service	38	35928	Snap Ring
2	— ⁽¹⁾	Drive Pinion & Gear Assembly	39	36326-2	Bolt – Hex
3	30764	Slinger – Inner Pinion Bearing	40	38532	Right Knuckle
4	706031X	KIT – Inner Pinion Bearing	41	38534	Left Knuckle
	706376X	PKG – Diff & Pinion Bearing Shim (inc items 5, 7, 13, 14, 73)	42	— ⁽³⁾	Nut – Hex Slotted
	706358X	PKG – Pinion Bearing Shim (inc items 5, 7, 13, 14)	43	— ⁽³⁾	Cotter Pin
			44	— ⁽⁵⁾	Tie Rod Assembly
5	—	Inner Pinion Bearing Shims (see shim packages)	45	565983	Bearing
			46	40191	Seal
			47	40173	Shaft – Output
6	30765	Baffle – Pinion Bearing	48	42998	Collar – Clutch
7	—	Outer Pinion Bearing Shims (see shim packages)	49	565985	Bearing
			50	— ⁽¹⁾	Shaft & Joint Assembly
8	706030X	KIT – Outer Pinion Bearing	51	36364	Slinger – Spindle Yoke
9	13575	Slinger – Outer Pinion Bearing		706527X	KIT – Spindle Seal & Bearing (52-55)
10	39118	Seal – Pinion Oil		706570X	KIT – Spindle (non-disco side) (inc items 52, 53, 54, 55, 56)
11	41498	Slinger – End Yoke		707013X	KIT – Spindle (disco side) (inc items 52, 53, 54, 55, 56)
12	2-4-8091-1X	End Yoke Assembly (inc 11)			
13	30186	Washer – Pinion Nut			
14	30185	Pinion Nut	52	38128	Oil Seal
	707008X	KIT – Carrier Cover (inc 16-25)	53	38106	Spacer – Wheel Bearing Spindle
	707005X	KIT – Small Parts (inc 18-25 & RTV)	54	36361	Oil Seal (block vee)
	707006X	KIT – Motor Assy' (inc 18-26 & RTV)	55	550759	Needle Bearing (non-disco side)
	707007X	KIT – Shift Fork (inc 18-25 & 27-30)		40608	Retainer – Oil Seal (disco side)
16	40189	Carrier Cover	56	38428	Spindle – Wheel Bearing
17	36918	Plug – Carrier Cover	57	35704	Nut – Brake Mounting
18	34279	Bolt – Carrier Cover (qty 10)	58	36366	Oil Seal
19	500360-15	Lockwasher	59	706074X	KIT – Inner Wheel Bearing
20	40182	Snap Rings	60	— ⁽³⁾	Hub and Rotor Assembly
21	621059	Clip – Shift Fork	61	706111X	KIT – Outer Wheel Bearing
22	40701	Gasket	62	21588X	Nut & Pin Assembly – Inner Lock
23	40691	Gasket	63	36569	Lock Nut
24	40187	Nut – Hex	64	31139	Nut – Wheel Bearing Adjusting
25	40184	Nut – Hex	65	32589	Plate – Spring Retaining
26	40732	Motor Assembly	66	35218	Spring – Pressure
27	40177	Shift Fork Assembly	67	42667	Gear – Axle Drive
28	40178	Lever and Sleeve Assembly	68	31624	Snap Ring
29	40190	Pin – Grooved	69	31552	Hub Cap
30	40180	Stud – Linkage	70	— ⁽³⁾	Differential Bearing Cap
31	— ⁽²⁾	Seal/Guide Tube (non-disco side)	71	48632-1	Bolt – Differential Bearing Cap
	706575X	KIT – Right Knuckle Assembly (inc 32,33,34,35,36,37,38,39,40)	72	706032X	KIT – Differential Bearing
	706576X	KIT – Left Knuckle Assembly (inc 32,33,34,35,36,37,38,39,41)	73	706086X	PKG – Differential Bearing Shim
	706116X	KIT – Socket Assembly (inc 32-38)	74	30187	Bolt – Drive Gear (qty 10)
32	35416	Nut – Hex Slotted	75	17717	Pinion – Differential
33	500024-6	Cotter Pin	76	40194	Gear – Differential
34	35417	Adjusting Split Ring	77	13338-3	Thrustwasher – Differential Pinion
35	40112	Socket Assembly	78	40196	Thrustwasher – Differential Gear
36	35566	Nut – Hex Jam	79	39194	Shaft – Differential
37	40113	Socket Assembly	80	42570	Snap Ring
			81	13449	Lock – Differential Shaft
			82	— ⁽⁴⁾	Case – Differential

(1) See "Bill of Material Table" on next page

(2) See "Variable Parts Table" within this section

(3) Contact Vehicle Manufacturer

(4) Not Sold Separately

(5) See Spicer Chassis Catalog for part number and additional steering parts

Jeep 44 /216 Disconnect Front Axles Bill of Material Table

Axle			Axle Kits				Shaft & Joint Assy.	
Bill of Material	Diff. Type	Ratio	Ring Gear & Pinion Kit ⁽⁷⁾	Differential			Right Hand Shaft Assy.	Left Hand Shaft Assy.
				Case Assy. Kit ⁽⁸⁾	Case Kit	Inner Parts Kit		
1982-84 Wagoneer, Cherokee Disconnect STD Track								
610157-2	Standard	3.31	706017-2X	706857X	706858X	706859X	660091-9	71557-1X
610157-5	Standard	2.72	706017-19X	706857X	706858X	706859X	660091-9	71557-1X
1982-84 J10, J20, Wide Track Cherokee								
610158-3	Standard	3.31	706017-2X	706857X	706858X	706859X	72801-4X	71557-2X
610158-8	Standard	2.72	706017-19X	706857X	706858X	706859X	72801-4X	71557-2X

NOTE: All Ring & Pinion Kits with base number 706930 are reverse spiral bevel.

(7) See Ring Gear & Pinion Kits in XGI Catalog for ratio & tooth combinations.

(8) See Differential Case Assy Kits in XGI Catalog for spline data & ratios.

(9) Differential Case has unequal journal diameters.

Variable Parts Listing

Kits & Parts - Use With All Applications						
Description & Item Number (Refer to "Exploded View")			Bills of Material			
			610157	610158		
1	Seal/Guide Tube (non-disco side)	31	620257	620216		

Jeep / Eagle 1985 1/2 - 1998 1/2

Model 35 /194 Rear Axles

- MJ (Military Jeep)**
- XJ (Cherokee /Comanche)**
- YJ /TJ (Wagoneer)**
- ZJ (Grand Cherokee)**

Jeep Model 35 /194 Rear Axles Exploded View

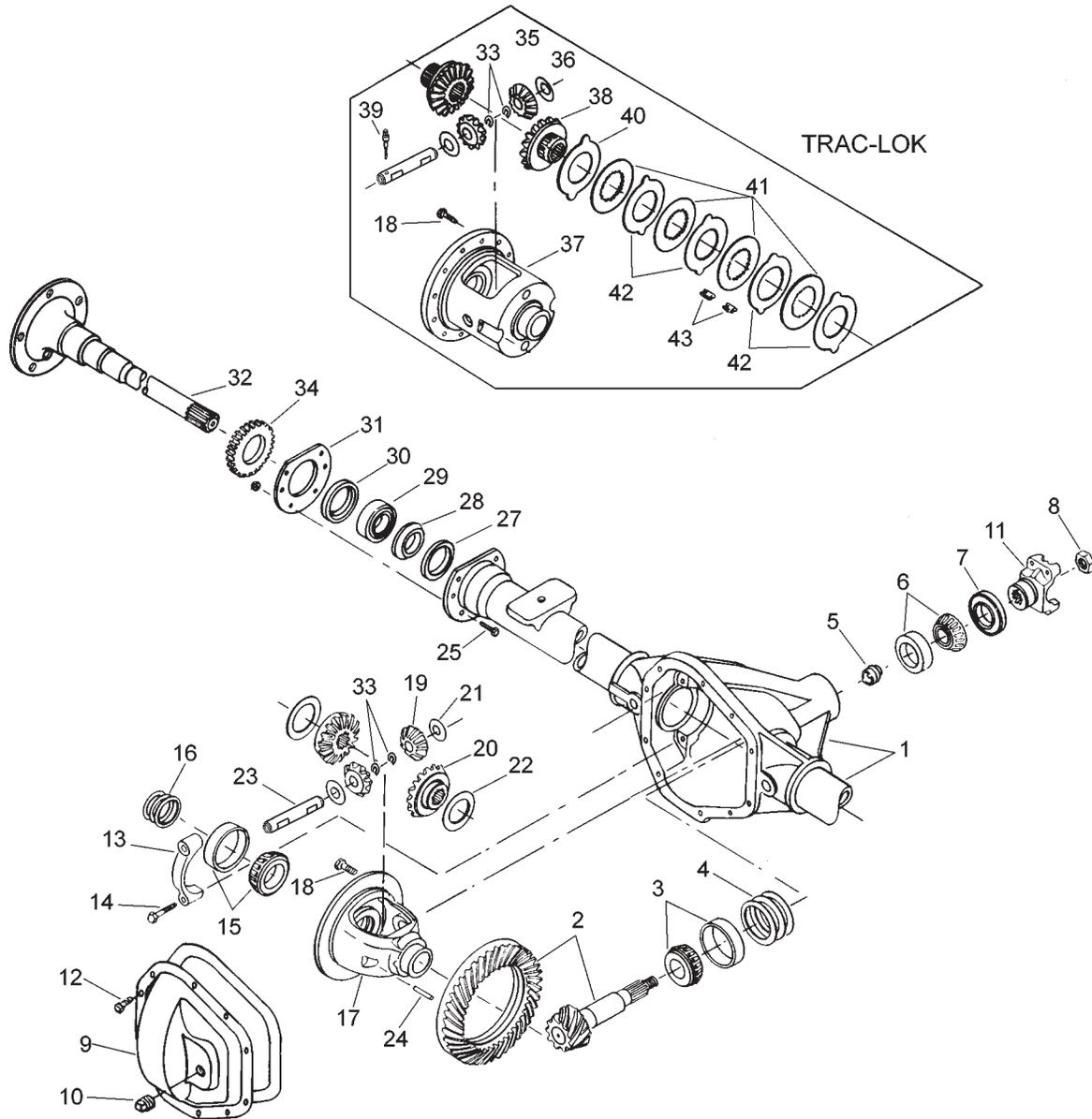

Jeep Model 35 /194 Rear Axles Parts Listing

ITEM NO.	PART NUMBER	DESCRIPTION	ITEM NO.	PART NUMBER	DESCRIPTION
1	— ⁽³⁾	Housing – Axle Service	25	— ⁽³⁾	Bolt – Brake Mounting
2	— ⁽¹⁾	Drive Pinion & Gear Assembly	26	— ⁽³⁾	Nut – Brake Mounting
3	707162X	KIT – Inner Pinion Bearing	27	— ⁽²⁾	Seal – Inboard Shaft
4	701121X	Inner Pinion Bearing Shims	28	— ⁽²⁾	Retainer Ring – Wheel Bearing
5	42102	Spacer – Collapsible	29	— ⁽²⁾	Wheel Bearing Assembly
6	706894X	KIT – Outer Pinion Bearing	30	— ⁽²⁾	Seal – Outboard Shaft
7	43085	Seal – Pinion Oil	31	— ⁽²⁾	Retainer – Oil Seal
8	44189	Pinion Nut	32	— ⁽¹⁾	Shaft – Axle Flanged Drive
	— ⁽²⁾	KIT – Carrier Cover (inc items 9, 10)	33	— ⁽²⁾	C – Clip
9	— ⁽²⁾	Carrier Cover	34	— ⁽²⁾	Tone Ring
10	— ⁽²⁾	Plug – Cover	35	41599	Pinion – Differential (t/l)
11	— ⁽²⁾	End Yoke	36	40266	Thrustwasher – Diff Pinion (t/l)
12	34279	Bolt – Carrier Cover (qty 10)	37	— ⁽¹⁾	Case – Differential (t/l)
13	— ⁽³⁾	Differential Bearing Cap	38	43234	Gear – Diff (t/l)
14	48631-1	Bolt – Differential Bearing Cap	39	42990	Shaft – Differential (t/l)
15	706016X	KIT – Differential Bearing		707165X	KIT – Diff Plate & Disc (t/l) (inc items 40, 41, 42, 43, 24)
16	73139X	PKG – Differential Bearing Shim	40	— ⁽⁴⁾	Plate – Preload Spacer
17	— ⁽¹⁾	Case – Differential (std)	41	— ⁽⁴⁾	Disc – Differential
18	41221	Bolt – Drive Gear	42	— ⁽⁴⁾	Plate – Differential Pressure
19	— ⁽²⁾	Pinion – Differential (std)	43	40835	Clip – Differential Clutch Retainer
20	— ⁽²⁾	Gear – Differential (std)	44	38615	RTV – Silicone Sealant
21	— ⁽²⁾	Thrustwasher – Diff Pinion (std)	N.I.	50068	Slinger – Pinion Oil Seal Outer
22	— ⁽²⁾	Thrustwasher – Diff Gear (std)	N.I.	48008	Oil Seal
23	— ⁽²⁾	Shaft – Differential (std)			(Item 45 & 46 used on WJ Model 198 only)
24	43245	Pin – Shaft Lock			

- (1) See "Bill of Material Table" on next page
(2) See "Variable Parts Table" within this section
(3) Contact Vehicle Manufacturer
(4) Not Sold Separately

Jeep Model 35 /194 Rear Axles

Bill of Material Table

Axle			Axle Kits				Shaft & Joint Assy.	
Bill of Material	Diff. Type	Ratio	Ring Gear & Pinion Kit ⁽⁷⁾	Differential			Right Hand Shaft Assy.	Left Hand Shaft Assy.
				Case Assy. Kit ⁽⁸⁾	Case Kit	Inner Parts Kit		
1985 1/2 XJ Utility								
605315-1	Standard	3.31	72896-5X ⁽⁸⁾	74209X	43218	707247X	73107-1X	73107-2X
605315-2	Standard	3.54	72933-5X ⁽⁸⁾	74209X	43218	707247X	73107-1X	73107-2X
605315-3	Standard	4.11	707244-4X	74209X	43218	707247X	73107-1X	73107-2X
605315-4	Trac Lok	4.11	707244-4X	74210X	707243X	706967-1X	73107-1X	73107-2X
605316-1	Standard	3.31	72896-5X ⁽⁸⁾	74209X	43218	707247X	73107-1X	73107-2X
605316-2	Standard	3.54	72933-5X ⁽⁸⁾	74209X	43218	707247X	73107-1X	73107-2X
605316-3	Standard	4.11	707244-4X	74209X	43218	707247X	73107-1X	73107-2X
605316-4	Trac Lok	4.11	707244-4X	74210X	707243X	706967-1X	73107-1X	73107-2X
1986 XJ Utility								
605290-1	Standard	3.31	72896-5X ⁽⁸⁾	74209X	43218	707247X	72900-1X	72900-2X
605290-2	Standard	3.54	72933-5X ⁽⁸⁾	74209X	43218	707247X	72900-1X	72900-2X
605290-3	Standard	4.11	72932-5X ⁽⁸⁾	74209X	43218	707247X	72900-1X	72900-2X
605290-4	Trac Lok	4.11	72932-5X ⁽⁸⁾	74210X	707243X	706967-1X	72900-1X	72900-2X
605293-1	Standard	3.31	72896-5X ⁽⁸⁾	74209X	43218	707247X	72912-1X	72912-2X
605293-2	Standard	3.54	72933-5X ⁽⁸⁾	74209X	43218	707247X	72912-1X	72912-2X
605293-3	Standard	4.11	707244-4X	74209X	43218	707247X	72912-1X	72912-2X
605293-4	Trac Lok	4.11	707244-4X	74210X	707243X	706967-1X	72912-1X	72912-2X
605293-7	Standard	4.56	707244-5X	74209X	43218	707247X	72912-1X	72912-2X
605293-8	Trac Lok	4.56	707244-5X	74210X	707243X	706967-1X	72912-1X	72912-2X
605293-9	Standard	3.08	72934-5X ⁽⁸⁾	74209X	43218	707247X	72912-1X	72912-2X
605293-10	Trac Lok	3.08	72934-5X ⁽⁸⁾	74210X	707243X	706967-1X	72912-1X	72912-2X
605293-11	Standard	3.55	707244-3X	74209X	43218	707247X	72912-1X	72912-2X
605293-12	Trac Lok	3.55	707244-3X	74210X	707243X	706967-1X	72912-1X	72912-2X
1986 XJ Pickup								
605292-1	Standard	3.31	72896-5X ⁽⁸⁾	74209X	43218	707247X	72900-1X	72900-2X
605292-2	Standard	3.54	72933-5X ⁽⁸⁾	74209X	43218	707247X	72900-1X	72900-2X
605292-3	Standard	4.11	72932-5X ⁽⁸⁾	74209X	43218	707247X	72900-1X	72900-2X
605292-4	Trac Lok	4.11	72932-5X ⁽⁸⁾	74210X	707243X	706967-1X	72900-1X	72900-2X
605294-1	Standard	3.31	72896-5X ⁽⁸⁾	74209X	43218	707247X	72912-1X	72912-2X
605294-2	Standard	3.54	72933-5X ⁽⁸⁾	74209X	43218	707247X	72912-1X	72912-2X
605294-3	Standard	4.11	707244-4X	74209X	43218	707247X	72912-1X	72912-2X
605294-4	Trac Lok	4.11	707244-4X	74210X	707243X	706967-1X	72912-1X	72912-2X
605294-5	Trac Lok	4.56	707244-5X	74210X	707243X	706967-1X	72912-1X	72912-2X
605294-6	Standard	4.56	707244-5X	74209X	43218	707247X	72912-1X	72912-2X
605294-7	Trac Lok	3.08	72934-5X ⁽⁸⁾	74210X	707243X	706967-1X	72912-1X	72912-2X
605294-8	Standard	3.08	72934-5X ⁽⁸⁾	74209X	43218	707247X	72912-1X	72912-2X
605294-9	Trac Lok	3.54	72933-5X ⁽⁸⁾	74210X	707243X	706967-1X	72912-1X	72912-2X
605294-10	Standard	3.55	707244-3X	74209X	43218	707247X	72912-1X	72912-2X
605294-11	Trac Lok	3.55	707244-3X	74210X	707243X	706967-1X	72912-1X	72912-2X
1987-89 YJ								
605295-1	Standard	2.73	72935-5X ⁽⁸⁾	74214X	43219	707247X	72912-1X	72912-2X
605295-2	Standard	3.07	707244-1X	74214X	43219	707247X	72912-1X	72912-2X
605295-3	Trac Lok	3.07	707244-1X	74215X	707242X	707349X	72912-1X	72912-2X
605295-4	Standard	4.11	707244-4X	74209X	43218	707247X	72912-1X	72912-2X
605295-5	Trac Lok	4.11	707244-4X	74210X	707243X	707349X	72912-1X	72912-2X
605295-6	Standard	3.55	707244-3X	74209X	43218	707247X	72912-1X	72912-2X
605295-7	Trac Lok	3.55	707244-3X	74210X	707243X	707349X	72912-1X	72912-2X

(7) See Ring Gear & Pinion Kits in XGI Catalog for ratio & tooth combinations.

(8) See Differential Case Assy Kits in XGI Catalog for spline data & ratios.

(9) Gear set includes ring gear, pinion and drive gear screws.

Jeep Model 35 /194 Rear Axles

Bill of Material Table

Axle			Axle Kits				Shaft & Joint Assy.	
Bill of Material	Diff. Type	Ratio	Ring Gear & Pinion Kit ⁽⁷⁾	Differential			Right Hand Shaft Assy.	Left Hand Shaft Assy.
				Case Assy. Kit ⁽⁸⁾	Case Kit	Inner Parts Kit		
1987-89 XJ Utility								
605323-1	Standard	3.07	707244-1X	74214X	43219	707247X	72912-1X	72912-2X
605323-2	Trac Lok	3.07	707244-1X	74215X	707242X	707349X	72912-1X	72912-2X
605323-3	Standard	3.31	707244-2X	74214X	43219	707247X	72912-1X	72912-2X
605323-5	Standard	3.55	707244-3X	74209X	43218	707247X	72912-1X	72912-2X
605323-6	Trac Lok	3.55	707244-3X	74210X	707243X	707349X	72912-1X	72912-2X
605323-7	Standard	4.11	707244-4X	74209X	43218	707247X	72912-1X	72912-2X
605323-8	Trac Lok	4.11	707244-4X	74210X	707243X	707349X	72912-1X	72912-2X
605323-9	Standard	4.56	707244-5X	74209X	43218	707247X	72912-1X	72912-2X
605323-10	Trac Lok	4.56	707244-5X	74210X	707243X	707349X	72912-1X	72912-2X
1987-89 XJ Pickup								
605324-1	Standard	3.07	707244-1X	74214X	43219	707247X	72912-1X	72912-2X
605324-2	Trac Lok	3.07	707244-1X	74215X	707242X	707349X	72912-1X	72912-2X
605324-3	Standard	3.31	707244-2X	74214X	43219	707247X	72912-1X	72912-2X
605324-5	Standard	3.55	707244-3X	74209X	43218	707247X	72912-1X	72912-2X
605324-6	Trac Lok	3.55	707244-3X	74210X	707243X	707349X	72912-1X	72912-2X
605324-7	Standard	4.11	707244-4X	74209X	43218	707247X	72912-1X	72912-2X
605324-8	Standard	4.56	707244-5X	74209X	43218	707247X	72912-1X	72912-2X
1988-89 XJ Utility, Trailer Tow - ABS								
605351-5	Standard	3.55	707244-3X	74209X	43218	707247X	73422-1X	73422-2X
605351-6	Trac Lok	3.55	707244-3X	74210X	707243X	707349X	73422-1X	73422-2X
1988-89 XJ Pickup								
605455-1	Standard	3.07	707244-1X	74214X	43219	707247X	72912-1X	72912-2X
1988 1/2-89 XJ Utility, I-6 Automatic								
605387-1	Standard	3.55	707244-3X	74209X	43218	707247X	72912-1X	72912-2X
605387-3	Standard	4.11	707244-4X	74209X	43218	707247X	72912-1X	72912-2X
605387-4	Trac Lok	4.11	707244-4X	74210X	707243X	707349X	72912-1X	72912-2X
605387-5	Standard	4.56	707244-5X	74209X	43218	707247X	72912-1X	72912-2X
1988 1/2-89 XJ Utility, Trailer Tow								
605389-5	Standard	3.55	707244-3X	74209X	43218	707247X	72912-1X	72912-2X
605389-6	Trac Lok	3.55	707244-3X	74210X	707243X	707349X	72912-1X	72912-2X
1990-90 1/2 XJ Utility								
605416-1	Standard	3.07	707244-1X	74214X	43219	707247X	73624-1X	73624-2X
605416-2	Trac Lok	3.07	707244-1X	74215X	707242X	707349X	73624-1X	73624-2X
1990-90 1/2 YJ								
605423-1	Standard	3.07	707244-1X	74214X	43219	707247X	73624-1X	73624-2X
605423-2	Trac Lok	3.07	707244-1X	74215X	707242X	707349X	73624-1X	73624-2X
605423-3	Standard	3.55	707244-3X	74209X	43218	707247X	73624-1X	73624-2X
605423-4	Trac Lok	3.55	707244-3X	74210X	707243X	707349X	73624-1X	73624-2X
605423-5	Standard	4.11	707244-4X	74209X	43218	707247X	73624-1X	73624-2X
605423-6	Trac Lok	4.11	707244-4X	74210X	707243X	707349X	73624-1X	73624-2X
605423-7	Standard	3.07	707244-1X	74214X	43219	707247X	73624-1X	73624-2X
605423-8	Standard	3.55	707244-3X	74209X	43218	707247X	73624-1X	73624-2X
605423-9	Trac Lok	3.55	707244-3X	74210X	707243X	707349X	73624-1X	73624-2X
605423-10	Standard	4.11	707244-4X	74209X	43218	707247X	73624-1X	73624-2X
605423-11	Trac Lok	4.11	707244-4X	74210X	707243X	707349X	73624-1X	73624-2X

(7) See Ring Gear & Pinion Kits in XGI Catalog for ratio & tooth combinations.

(8) See Differential Case Assy Kits in XGI Catalog for spline data & ratios.

(9) Gear set includes ring gear, pinion and drive gear screws.

Jeep Model 35 /194 Rear Axles Bill of Material Table

Axle			Axle Kits				Shaft & Joint Assy.	
Bill of Material	Diff. Type	Ratio	Ring Gear & Pinion Kit ⁽⁷⁾	Differential			Right Hand Shaft Assy.	Left Hand Shaft Assy.
				Case Assy. Kit ⁽⁸⁾	Case Kit	Inner Parts Kit		
1990-90 1/2 MJ Pickup								
605425-1	Standard	3.07	707244-1X	74214X	43219	707247X	73624-1X	73624-2X
605425-5	Standard	3.55	707244-3X	74209X	43218	707247X	73624-1X	73624-2X
605425-6	Trac Lok	3.55	707244-3X	74210X	707243X	707349X	73624-1X	73624-2X
605425-7	Standard	4.11	707244-4X	74209X	43218	707247X	73624-1X	73624-2X
605425-8	Standard	4.56	707244-5X	74209X	43218	707247X	73624-1X	73624-2X
605425-9	Standard	3.07	707244-1X	74214X	43219	707247X	73624-1X	73624-2X
605425-10	Standard	3.55	707244-3X	74209X	43218	707247X	73624-1X	73624-2X
605425-11	Standard	4.11	707244-4X	74209X	43218	707247X	73624-1X	73624-2X
605425-12	Standard	4.56	707244-5X	74209X	43218	707247X	73624-1X	73624-2X
1990-90 1/2 XJ Utility, I-6 Automatic								
605443-1	Standard	3.55	707244-3X	74209X	43218	707247X	73624-1X	73624-2X
605443-3	Standard	4.11	707244-4X	74209X	43218	707247X	73624-1X	73624-2X
605443-4	Trac Lok	4.11	707244-4X	74210X	707243X	707349X	73624-1X	73624-2X
605443-5	Standard	4.56	707244-5X	74209X	43218	707247X	73624-1X	73624-2X
1990-90 1/2 XJ Utility, Trailer Tow								
605444-1	Standard	3.55	707244-3X	74209X	43218	707247X	73624-1X	73624-2X
605444-2	Trac Lok	3.55	707244-3X	74210X	707243X	707349X	73624-1X	73624-2X
1990-91 1/2 XJ Utility, Trailer Tow - ABS								
605427-1	Standard	3.55	707244-3X	74209X	43218	707247X	73879-1X	73879-2X
605427-2	Trac Lok	3.55	707244-3X	74210X	707243X	707349X	73879-1X	73879-2X
1990-92 1/2 XJ Utility								
605483-1	Trac Lok	3.07	707244-1X	74215X	707242X	707349X	73624-1X	73624-2X
605483-2	Standard	3.07	707244-1X	74214X	43219	707247X	73624-1X	73624-2X
1990-92 1/2 XJ Utility, I-6 Automatic								
605484-1	Trac Lok	4.11	707244-4X	74210X	707243X	707349X	73624-1X	73624-2X
605484-2	Standard	3.55	707244-3X	74209X	43218	707247X	73624-1X	73624-2X
605484-3	Standard	4.11	707244-4X	74209X	43218	707247X	73624-1X	73624-2X
605484-4	Standard	4.56	707244-5X	74209X	43218	707247X	73624-1X	73624-2X
1990-92 1/2 XJ Utility, Trailer Tow								
605485-1	Trac Lok	3.55	707244-3X	74210X	707243X	707349X	73624-1X	73624-2X
605485-2	Standard	3.55	707244-3X	74209X	43218	707247X	73624-1X	73624-2X
1991-93 1/2 YJ								
605502-1	Standard	3.07	707244-1X	74214X	43219	707247X	73624-1X	73624-2X
605502-2	Standard	3.55	707244-3X	74209X	43218	707247X	73624-1X	73624-2X
605502-3	Trac Lok	3.55	707244-3X	74210X	707243X	707349X	73624-1X	73624-2X
605502-4	Standard	4.11	707244-4X	74209X	43218	707247X	73624-1X	73624-2X
605502-5	Trac Lok	4.11	707244-4X	74210X	707243X	707349X	73624-1X	73624-2X
605502-6	Standard	3.73	74711-5X ⁽⁹⁾	74209X	43218	707247X	73624-1X	73624-2X
605502-7	Trac Lok	3.73	74711-5X ⁽⁹⁾	74210X	707243X	707349X	73624-1X	73624-2X
605502-8	Trac Lok	4.11	707244-4X	74210X	707243X	707349X	73624-1X	73624-2X
605502-9	Standard	4.11	707244-4X	74209X	43218	707247X	73624-1X	73624-2X
605502-10	Trac Lok	3.55	707244-3X	74210X	707243X	707349X	73624-1X	73624-2X
605502-11	Standard	3.55	707244-3X	74209X	43218	707247X	73624-1X	73624-2X
605502-12	Standard	3.07	707244-1X	74214X	43219	707247X	73624-1X	73624-2X

(7) See Ring Gear & Pinion Kits in XGI Catalog for ratio & tooth combinations.

(8) See Differential Case Assy Kits in XGI Catalog for spline data & ratios.

(9) Gear set includes ring gear, pinion and drive gear screws.

Jeep Model 35 /194 Rear Axles

Bill of Material Table

Axle			Axle Kits				Shaft & Joint Assy.	
Bill of Material	Diff. Type	Ratio	Ring Gear & Pinion Kit ⁽⁷⁾	Differential			Right Hand Shaft Assy.	Left Hand Shaft Assy.
				Case Assy. Kit ⁽⁸⁾	Case Kit	Inner Parts Kit		
1991-93 1/2 MJ Pickup								
605500-1	Standard	3.55	707244-3X	74209X	43218	707247X	73624-1X	73624-2X
605500-2	Standard	4.11	707244-4X	74209X	43218	707247X	73624-1X	73624-2X
605500-3	Standard	3.07	707244-1X	74214X	43219	707247X	73624-1X	73624-2X
605500-4	Trac Lok	3.55	707244-3X	74210X	707243X	707349X	73624-1X	73624-2X
1992-93 1/2 YJ - ABS								
605525-1	Standard	3.55	707244-3X	74209X	43218	707247X	74356-1X	74356-2X
605525-2	Trac Lok	3.55	707244-3X	74210X	707243X	707349X	74356-1X	74356-2X
605525-5	Standard	3.55	707244-3X	74209X	43218	707247X	74356-1X	74356-2X
605525-6	Trac Lok	3.55	707244-3X	74210X	707243X	707349X	74356-1X	74356-2X
605541-3	Standard	3.07	707244-1X	74214X	43219	707247X	74356-1X	74356-2X
605541-4	Trac Lok	3.07	707244-1X	74215X	707242X	707349X	74356-1X	74356-2X
605541-5	Standard	3.07	707244-1X	74214X	43219	707247X	74356-1X	74356-2X
605541-6	Trac Lok	3.07	707244-1X	74215X	707242X	707349X	74356-1X	74356-2X
605564-1	Standard	3.55	707244-3X	74209X	43218	707247X	74356-1X	74356-2X
605564-2	Trac Lok	3.55	707244-3X	74210X	43244	707349X	74356-1X	74356-2X
605564-3	Standard	3.55	707244-3X	74209X	43218	707247X	74356-1X	74356-2X
605564-4	Trac Lok	3.55	707244-3X	74210X	707243X	707349X	74356-1X	74356-2X
1992 1/2-93 1/2 XJ Utility, Std								
605534-1	Standard	3.07	707244-1X	74214X	43219	707247X	73624-1X	73624-2X
605534-2	Trac Lok	3.07	707244-1X	74215X	707242X	707349X	73624-1X	73624-2X
605535-1	Standard	3.55	707244-3X	74211X	43218	707247X	73624-1X	73624-2X
605535-2	Standard	4.11	707244-4X	74211X	43218	707247X	73624-1X	73624-2X
605535-3	Trac Lok	4.11	707244-4X	74210X	707243X	707349X	73624-1X	73624-2X
605535-4	Standard	4.56	707244-5X	74211X	43218	707247X	73624-1X	73624-2X
605535-5	Standard	3.73	74711-5X ⁽⁹⁾	74211X	43218	707247X	73624-1X	73624-2X
605535-6	Trac Lok	3.73	74711-5X ⁽⁹⁾	74210X	707243X	707349X	73624-1X	73624-2X
605536-1	Standard	3.55	707244-3X	74209X	43218	707247X	73624-1X	73624-2X
605536-2	Trac Lok	3.55	707244-3X	74210X	707243X	707349X	73624-1X	73624-2X
1993-93 1/2 YJ - ABS								
605528-1	Standard	3.07	707244-1X	75053X	44649	707321X	74356-1X	74356-2X
605528-2	Standard	3.55	707244-3X	75054X	44590	707321X	74356-1X	74356-2X
605528-3	Trac Lok	3.55	707244-3X	74210X	707243X	707349X	74356-1X	74356-2X
605528-6	Standard	3.07	707244-1X	75053X	44649	707321X	74356-1X	74356-2X
605528-7	Standard	3.55	707244-3X	75054X	44590	707321X	74356-1X	74356-2X
1993-94 ZJ - ABS								
605475-1	Standard	3.55	707244-7X	75054X	44590	707321X	74356-1X	74356-2X
605475-2	Trac Lok	3.55	707244-7X	74210X	707243X	707349X	74356-1X	74356-2X
605475-3	Standard	3.31	707244-6X	74659X	44592	707321X	74356-1X	74356-2X
605475-5	Standard	3.07	707244-1X	74659X	44592	707321X	74356-1X	74356-2X
605475-6	Trac Lok	3.07	707244-1X	74215X	707242X	707349X	74356-1X	74356-2X
605475-7	Standard	3.73	707244-8X	75054X	44590	707321X	74356-1X	74356-2X
605475-8	Trac Lok	3.73	707244-8X	74210X	707243X	707349X	74356-1X	74356-2X
605475-9	Standard	3.55	707244-7X	75054X	44590	707321X	74356-1X	74356-2X
605475-10	Trac Lok	3.55	707244-7X	74210X	707243X	707349X	74356-1X	74356-2X
605475-11	Standard	3.73	707244-8X	75054X	44590	707321X	74356-1X	74356-2X
605475-12	Trac Lok	3.73	707244-8X	74210X	707243X	707349X	74356-1X	74356-2X

(7) See Ring Gear & Pinion Kits in XGI Catalog for ratio & tooth combinations.

(8) See Differential Case Assy Kits in XGI Catalog for spline data & ratios.

(9) Gear set includes ring gear, pinion and drive gear screws.

Jeep Model 35 /194 Rear Axles

Bill of Material Table

Axle			Axle Kits				Shaft & Joint Assy.	
Bill of Material	Diff. Type	Ratio	Ring Gear & Pinion Kit ⁽⁷⁾	Differential			Right Hand Shaft Assy.	Left Hand Shaft Assy.
				Case Assy. Kit ⁽⁸⁾	Case Kit	Inner Parts Kit		
1993-94 ZJ T/TOW - ABS								
605507-1	Standard	3.55	707244-7X	75054X	44590	707321X	74356-1X	74356-2X
605507-2	Trac Lok	3.55	707244-7X	74210X	707243X	707349X	74356-1X	74356-2X
605507-5	Standard	3.73	707244-8X	75054X	44590	707321X	74356-1X	74356-2X
605507-6	Trac Lok	3.73	707244-8X	74210X	707243X	707349X	74356-1X	74356-2X
605507-7	Standard	3.55	707244-7X	75054X	44590	707321X	74356-1X	74356-2X
605507-8	Trac Lok	3.55	707244-7X	74210X	707243X	707349X	74356-1X	74356-2X
605507-9	Standard	3.73	707244-8X	75054X	44590	707321X	74356-1X	74356-2X
605507-10	Trac Lok	3.73	707244-8X	74210X	707243X	707349X	74356-1X	74356-2X
1993-94 XJ Utility - ABS								
605579-1	Standard	3.55	707244-7X	75054X	44590	707321X	74356-1X	74356-2X
605579-2	Trac Lok	3.55	707244-7X	74210X	707243X	707349X	74356-1X	74356-2X
1994 ZJ - ABS								
605602-1	Standard	3.55	707244-7X	75054X	44590	707321X	74789-1X	74789-2X
605602-2	Trac Lok	3.55	707244-7X	74210X	707243X	707349X	74789-1X	74789-2X
605602-3	Standard	3.73	707244-8X	75054X	44590	707321X	74789-1X	74789-2X
605602-4	Trac Lok	3.73	707244-8X	74210X	707243X	707349X	74789-1X	74789-2X
605602-5	Standard	3.55	707244-7X	75054X	44590	707321X	74789-1X	74789-2X
605602-6	Standard	3.55	707244-7X	75054X	44590	707321X	74789-1X	74789-2X
605602-7	Trac Lok	3.55	707244-7X	74210X	707243X	707349X	74789-1X	74789-2X
605602-8	Standard	3.73	707244-8X	75054X	44590	707321X	74789-1X	74789-2X
605602-9	Trac Lok	3.73	707244-8X	74210X	707243X	707349X	74789-1X	74789-2X
605607-1	Standard	3.55	707244-7X	75054X	44590	707321X	74789-1X	74789-2X
605607-2	Trac Lok	3.55	707244-7X	74210X	707243X	707349X	74789-1X	74789-2X
605607-3	Standard	3.73	707244-8X	75054X	44590	707321X	74789-1X	74789-2X
605607-4	Trac Lok	3.73	707244-8X	74210X	707243X	707349X	74789-1X	74789-2X
605607-5	Standard	3.73	707244-8X	75054X	44590	707321X	74789-1X	74789-2X
605607-6	Trac Lok	3.73	707244-8X	74210X	707243X	707349X	74789-1X	74789-2X
605607-7	Standard	3.55	707244-7X	75054X	44590	707321X	74789-1X	74789-2X
605607-8	Trac Lok	3.55	707244-7X	74210X	707243X	707349X	74789-1X	74789-2X
605607-9	Standard	3.73	707244-8X	75054X	44590	707321X	74789-1X	74789-2X
605607-10	Trac Lok	3.73	707244-8X	74210X	707243X	707349X	74789-1X	74789-2X
1994 XJ Utility - Non ABS								
605655-1	Standard	3.07	707244-1X	75053X	44649	707321X	73624-1X	73624-2X
605655-2	Trac Lok	3.07	707244-1X	74215X	707242X	707349X	73624-1X	73624-2X
605656-1	Standard	3.55	707244-7X	75054X	44590	707321X	73624-1X	73624-2X
605656-2	Standard	4.11	707244-4X	75054X	44590	707321X	73624-1X	73624-2X
605656-3	Trac Lok	4.11	707244-4X	74210X	707243X	707349X	73624-1X	73624-2X
605656-4	Standard	3.73	707244-8X	75054X	44590	707321X	73624-1X	73624-2X
605656-5	Trac Lok	3.73	707244-8X	74210X	707243X	707349X	73624-1X	73624-2X
605660-1	Standard	3.55	707244-7X	75054X	44590	707321X	73624-1X	73624-2X
605660-2	Trac Lok	3.55	707244-7X	74210X	707243X	707349X	73624-1X	73624-2X
605660-3	Standard	3.73	707244-8X	75054X	44590	707321X	73624-1X	73624-2X
605660-4	Trac Lok	3.73	707244-8X	74210X	707243X	707349X	73624-1X	73624-2X

NOTE: All Ring & Pinion Kits with base number 706930 are reverse spiral bevel
 (7) See Ring Gear & Pinion Kits in XGI Catalog for ratio & tooth combinations.
 (8) See Differential Case Assy Kits in XGI Catalog for spline data & ratios.

Jeep Model 35 /194 Rear Axles

Bill of Material Table

Axle			Axle Kits				Shaft & Joint Assy.	
Bill of Material	Diff. Type	Ratio	Ring Gear & Pinion Kit ⁽⁷⁾	Differential			Right Hand Shaft Assy.	Left Hand Shaft Assy.
				Case Assy. Kit ⁽⁸⁾	Case Kit	Inner Parts Kit		
1994 XJ Utility - ABS								
605657-1	Standard	3.55	707244-7X	75054X	44590	707321X	74356-1X	74356-2X
605657-2	Trac Lok	3.55	707244-7X	74210X	707243X	707349X	74356-1X	74356-2X
605657-3	Trac Lok	3.73	707244-8X	74210X	707243X	707349X	74356-1X	74356-2X
605658-1	Standard	3.07	707244-1X	75053X	44649	707321X	74356-1X	74356-2X
605658-2	Trac Lok	3.07	707244-1X	74215X	707242X	707349X	74356-1X	74356-2X
605659-1	Standard	3.55	707244-7X	75054X	44590	707321X	74356-1X	74356-2X
605659-2	Trac Lok	3.55	707244-7X	74210X	707243X	707349X	74356-1X	74356-2X
605725-1	Standard	3.55	707244-7X	75054X	44590	707321X	74356-1X	74356-2X
605725-2	Trac Lok	3.55	707244-5X	74210X	707243X	707349X	74356-1X	74356-2X
1994-96 YJ/TJ - Non ABS								
605661-1	Trac Lok	4.11	707244-4X	74210X	707243X	707349X	73624-1X	73624-2X
605661-2	Standard	4.11	707244-4X	75054X	44590	707321X	73624-1X	73624-2X
605661-3	Trac Lok	3.55	707244-7X	74210X	707243X	707349X	73624-1X	73624-2X
605661-4	Standard	3.55	707244-7X	75054X	44590	707321X	73624-1X	73624-2X
605661-5	Standard	3.07	707244-1X	75053X	44649	707321X	73624-1X	73624-2X
605661-6	Standard	3.73	707244-8X	75054X	44590	707321X	73624-1X	73624-2X
605661-7	Trac Lok	3.73	707244-8X	74210X	707243X	707349X	73624-1X	73624-2X
605661-8	Standard	3.73	707244-8X	75054X	44590	707321X	73624-1X	73624-2X
605661-9	Trac Lok	3.73	707244-8X	74210X	707243X	707349X	73624-1X	73624-2X
1994-96 YJ/TJ - ABS								
605662-1	Standard	3.07	707244-1X	75053X	44649	707321X	74356-1X	74356-2X
605662-2	Standard	3.55	707244-3X	75054X	44590	707321X	74356-1X	74356-2X
605662-3	Trac Lok	3.55	707244-3X	74210X	707243X	707349X	74356-1X	74356-2X
1995-96 ZJ - ABS								
605706-1	Standard	3.55	707244-7X	75054X	44590	707321X	74789-1X	74789-2X
605707-1	Standard	3.73	707244-8X	75054X	44590	707321X	74789-1X	74789-2X
605707-2	Trac Lok	3.73	707244-8X	74210X	707243X	707349X	74789-1X	74789-2X
1995-96 XJ Utility - Non ABS								
605728-1	Standard	3.07	707244-1X	75053X	44649	707321X	73624-1X	73624-2X
605728-2	Trac Lok	3.07	707244-1X	74215X	707242X	707349X	73624-1X	73624-2X
605729-1	Standard	3.55	707244-7X	75054X	44590	707321X	73624-1X	73624-2X
605729-2	Standard	4.11	707244-4X	75054X	44590	707321X	73624-1X	73624-2X
605729-3	Trac Lok	4.11	707244-4X	74210X	707243X	707349X	73624-1X	73624-2X
605729-4	Standard	3.73	707244-8X	75054X	44590	707321X	73624-1X	73624-2X
605729-5	Trac Lok	3.73	707244-8X	74210X	707243X	707349X	73624-1X	73624-2X
1995-96 XJ Utility - ABS								
605731-1	Standard	3.07	707244-1X	75053X	44649	707321X	74356-1X	74356-2X
605731-2	Trac Lok	3.07	707244-1X	74215X	707242X	707349X	74356-1X	74356-2X
1995-96 1/2 XJ Utility - ABS								
605727-1	Standard	3.55	707244-7X	75054X	44590	707321X	74356-1X	74356-2X
605727-2	Trac Lok	3.55	707244-7X	74210X	707243X	707349X	74356-1X	74356-2X
605730-1	Standard	3.55	707244-7X	75054X	44590	707321X	74356-1X	74356-2X
605730-2	Trac Lok	3.55	707244-7X	74210X	707243X	707349X	74356-1X	74356-2X
605730-3	Trac Lok	3.73	707244-8X	74210X	707243X	707349X	74356-1X	74356-2X
605732-1	Standard	3.55	707244-7X	75054X	44590	707321X	74356-1X	74356-2X
605732-2	Trac Lok	3.55	707244-7X	74210X	707243X	707349X	74356-1X	74356-2X

NOTE: All Ring & Pinion Kits with base number 706930 are reverse spiral bevel

(7) See Ring Gear & Pinion Kits in XGI Catalog for ratio & tooth combinations.

(8) See Differential Case Assy Kits in XGI Catalog for spline data & ratios.

Jeep Model 35 /194 Rear Axles

Bill of Material Table

Axle			Axle Kits				Shaft & Joint Assy.	
Bill of Material	Diff. Type	Ratio	Ring Gear & Pinion Kit ⁽⁷⁾	Differential			Right Hand Shaft Assy.	Left Hand Shaft Assy.
				Case Assy. Kit ⁽⁸⁾	Case Kit	Inner Parts Kit		
1995-96 1/2 XJ Utility								
605733-1	Standard	3.55	707244-7X	75054X	44590	707321X	73624-1X	73624-2X
605733-2	Trac Lok	3.55	707244-7X	74210X	707243X	707349X	73624-1X	73624-2X
605733-3	Standard	3.73	707244-8X	75054X	44590	707321X	73624-1X	73624-2X
605733-4	Trac Lok	3.73	707244-8X	74210X	707243X	707349X	73624-1X	73624-2X
1996-96 1/2 XJ Diesel								
605775-1	Trac Lok	3.73	707244-8X	74210X	707243X	707349X	73624-1X	73624-2X
605775-2	Standard	3.73	707244-8X	75054X	44590	707321X	73624-1X	73624-2X
605775-3	Trac Lok	3.73	707244-8X	74210X	707243X	707349X	73624-1X	73624-2X
605775-4	Standard	3.73	707244-8X	75054X	44590	707321X	73624-1X	73624-2X
605776-1	Trac Lok	3.73	707244-8X	74210X	707243X	707349X	74356-1X	74356-2X
1996 1/2 YJ/TJ - ABS								
605746-1	Standard	3.07	707244-1X	75053X	44649	707321X	74356-1X	74356-2X
605746-2	Trac Lok	3.07	707244-1X	74215X	707242X	707349X	74356-1X	74356-2X
605746-4	Trac Lok	3.55	707244-7X	74210X	707243X	707349X	74356-1X	74356-2X
1996 1/2 YJ/TJ - Non ABS								
605747-1	Standard	3.07	707244-1X	75053X	44649	707321X	73624-1X	73624-2X
605747-2	Trac Lok	3.07	707244-1X	74215X	707242X	707349X	73624-1X	73624-2X
605747-3	Standard	3.55	707244-7X	75054X	44590	707321X	73624-1X	73624-2X
605747-4	Trac Lok	3.55	707244-7X	74210X	707243X	707349X	73624-1X	73624-2X
605747-5	Standard	4.11	707244-4X	75054X	44590	707321X	73624-1X	73624-2X
605747-6	Trac Lok	4.11	707244-4X	74210X	707243X	707349X	73624-1X	73624-2X
605747-9	Standard	3.73	707244-7X	75054X	44590	707321X	73624-1X	73624-2X
1996 1/2 XJ Utility - Non ABS								
605893-1	Trac Lok	3.07	707244-1X	74215X	707242X	707349X	73624-1X	73624-2X
605894-1	Trac Lok	4.11	707244-4X	74210X	707243X	707349X	73624-1X	73624-2X
1996 1/2 XJ Utility - ABS								
605895-1	Standard	3.07	707244-1X	75053X	44649	707321X	74356-1X	74356-2X
605895-2	Trac Lok	3.07	707244-1X	74215X	707242X	707349X	74356-1X	74356-2X
1996 1/2 XJ Diesel - ABS								
605909-1	Trac Lok	3.73	707244-8X	74210X	707243X	707349X	74356-1X	74356-2X
1996 1/2-97 ZJ - ABS								
605797-3	Standard	3.73	707244-8X	75054X	44590	707321X	74789-1X	74789-2X
605797-4	Trac Lok	3.73	707244-8X	74210X	707243X	707349X	74789-1X	74789-2X
605798-1	Standard	3.55	707244-7X	75054X	44590	707321X	74789-1X	74789-2X
1997 TJ - ABS								
605956-1	Standard	3.07	707244-1X	75053X	44649	707321X	74356-1X	74356-2X
605956-4	Trac Lok	3.55	707244-7X	74210X	707243X	707349X	74356-1X	74356-2X
1997 TJ - Non ABS								
605957-1	Standard	3.07	707244-1X	75053X	44649	707321X	73624-1X	73624-2X
605957-2	Trac Lok	3.07	707244-1X	74215X	43217	707349X	73624-1X	73624-2X
605957-3	Standard	3.55	707244-7X	75054X	44590	707321X	73624-1X	73624-2X
605957-4	Trac Lok	3.55	707244-7X	74210X	707243X	707349X	73624-1X	73624-2X
605957-5	Standard	4.11	707244-4X	75054X	44590	707321X	73624-1X	73624-2X
605957-6	Trac Lok	4.11	707244-4X	74210X	707243X	707349X	73624-1X	73624-2X
605957-7	Standard	3.73	707244-8X	75054X	44590	707321X	73624-1X	73624-2X
605957-8	Trac Lok	3.73	707244-8X	74210X	707243X	707349X	73624-1X	73624-2X

NOTE: All Ring & Pinion Kits with base number 706930 are reverse spiral bevel

(7) See Ring Gear & Pinion Kits in XGI Catalog for ratio & tooth combinations.

(8) See Differential Case Assy Kits in XGI Catalog for spline data & ratios.

Jeep Model 35 /194 Rear Axles

Bill of Material Table

Axle			Axle Kits				Shaft & Joint Assy.	
Bill of Material	Diff. Type	Ratio	Ring Gear & Pinion Kit ⁽⁷⁾	Differential			Right Hand Shaft Assy.	Left Hand Shaft Assy.
				Case Assy. Kit ⁽⁸⁾	Case Kit	Inner Parts Kit		
1997 XJ Utility - ABS								
605913-1	Trac Lok	3.55	707244-7X	74210X	43233	707349X	74356-1X	74356-2X
605914-1	Standard	3.55	707244-7X	75054X	44590	707321X	74356-1X	74356-2X
605914-2	Trac Lok	3.55	707244-7X	707243X	74210X	707349X	74356-1X	74356-2X
605918-1	Standard	3.07	707244-1X	75053X	44590	707321X	74386-1X	74386-2X
605918-2	Trac Lok	3.07	707244-1X	74215X	43217	707349X	74386-1X	74386-2X
1997 XJ Diesel, Non ABS								
605916-1	Standard	3.73	707244-8X	75054X	44590	707321X	73624-1X	73624-2X
605916-2	Trac Lok	3.73	707244-8X	74210X	43233	707349X	73624-1X	73624-2X
1997 XJ Diesel - ABS								
605919-1	Trac Lok	3.73	707244-8X	74210X	43233	707349X	74356-1X	74356-2X
1997-98 1/2 ZJ - ABS								
605960-1	Standard	3.55	707244-7X	75054X	44590	707321X	74789-1X	74789-2X
605961-3	Standard	3.73	707244-8X	75054X	44590	707321X	74789-1X	74789-2X
605961-4	Trac Lok	3.73	707244-8X	74210X	707243X	707349X	74789-1X	74789-2X
1997 1/2-99 XJ Utility - ABS								
606031-1	Trac Lok	3.55	707244-7X	74210X	707243X	707349X	74356-1X	74356-2X
606032-1	Standard	3.55	707244-7X	75054X	44590	707321X	74356-1X	74356-2X
606032-2	Trac Lok	3.55	707244-7X	74210X	707243X	707349X	74356-1X	74356-2X
606034-1	Standard	3.07	707244-1X	75053X	44649	707321X	74356-1X	74356-2X
606034-2	Trac Lok	3.07	707244-1X	74215X	707242X	707349X	74356-1X	74356-2X
1997 1/2-99 XJ Diesel - Non ABS								
606033-1	Standard	3.73	707244-8X	75054X	44590	707321X	73624-1X	73624-2X
606033-2	Trac Lok	3.73	707244-8X	74210X	707243X	707349X	73624-1X	73624-2X
606033-3	Trac Lok	3.07	707244-1X	74215X	707242X	707349X	73624-1X	73624-2X
1997 1/2-99 XJ Diesel - ABS								
606035-1	Trac Lok	3.73	707244-8X	74210X	707243X	707349X	74356-1X	74356-2X
1997 1/2-2000 TJ - ABS								
605992-1	Standard	3.07	707244-1X	75053X	44649	707321X	74356-1X	74356-2X
605992-4	Trac Lok	3.55	707244-7X	74210X	707243X	707349X	74356-1X	74356-2X
605992-6	Trac Lok	3.73	707244-8X	74210X	707243X	707349X	74356-1X	74356-2X
1997 1/2-2000 TJ - Non ABS								
605993-1	Standard	3.07	707244-1X	75053X	44649	707321X	73624-1X	73624-2X
605993-2	Trac Lok	3.07	707244-1X	74215X	43217	707349X	73624-1X	73624-2X
605993-3	Standard	3.55	707244-7X	75054X	44590	707321X	73624-1X	73624-2X
605993-4	Trac Lok	3.55	707244-7X	74210X	707243X	707349X	73624-1X	73624-2X
605993-5	Standard	4.11	707244-4X	75054X	44590	707321X	73624-1X	73624-2X
605993-6	Trac Lok	4.11	707244-4X	74210X	707243X	707349X	73624-1X	73624-2X
605993-7	Standard	3.73	707244-8X	75054X	44590	707321X	73624-1X	73624-2X
605993-8	Trac Lok	3.73	707244-8X	74210X	707243X	707349X	73624-1X	73624-2X
1998 1/2-99 XJ Utility								
606103-1	Trac Lok	3.55	707244-7X	74215X	707243X	707349X	73624-1X	73624-2X

NOTE: All Ring & Pinion Kits with base number 706930 are reverse spiral bevel

(7) See Ring Gear & Pinion Kits in XGI Catalog for ratio & tooth combinations.

(8) See Differential Case Assy Kits in XGI Catalog for spline data & ratios.

Jeep Model 35 /194 Rear Axles Variable Parts Listing

Kits & Parts - Use With All Applications							
Description & Item Number (Refer to "Exploded View")			Bills of Material				
			605290 605292	605293 605294 605295	605315 605316	605323 605324	605351
1	KIT – Carrier Cover	-	73605X	73605X	73605X	73605X	73605X
2	Pinion Nut	9	42968	42968	42968	42968	42968
3	Plug – Cover	10	43180	43180	43180	43180	43180
4	End Yoke	11	2-4-4601-1	2-4-4601-1	2-4-4601-1	2-4-4601-1	2-4-4601-1
5	Pinion – Differential (std)	19	43719	43719	43719	43719	43719
6	Gear – Differential (std)	20	43718	43718	43718	43718	43718
7	Thrustwasher – Diff Pinion (std)	21	42077	42077	42077	42077	42077
8	Thrustwasher – Diff Gear (std)	22	42078	42078	42078	42078	42078
9	Shaft – Differential (std)	23	43220	43220	43220	43220	43220
10	Seal – Inboard Shaft	27	42046	33353	42046	33353	33353
11	Retainer Ring – Wheel Bearing	28	42052	36121	42052	36121	36121
12	Wheel Bearing Assembly	29	565909	565909	565909	565909	565909
13	Seal – Outboard Shaft	30	35938	35938	35938	35938	35938
14	Retainer – Oil Seal	31	41999	42101	42101	42101	42101
15	C – Clip	33	—	—	—	—	—
16	Tone Ring	34	—	—	—	—	42790
			605387	605389	605416 605423 605425	605427	605443 605444
1	KIT – Carrier Cover	-	73605X	73605X	74208X	74208X	74208X
2	Pinion Nut	9	43225	42968	43225	43225	43225
3	Plug – Cover	10	41356	43180	41356	41356	41356
4	End Yoke	11	2-4-4601-1	2-4-4601-1	2-4-4601-1	2-4-4601-1	2-4-4601-1
5	Pinion – Differential (std)	19	43719	43719	43719	43719	43719
6	Gear – Differential (std)	20	43718	43718	43718	43718	43718
7	Thrustwasher – Diff Pinion (std)	21	42077	42077	42077	42077	42077
8	Thrustwasher – Diff Gear (std)	22	42078	42078	42078	42078	42078
9	Shaft – Differential (std)	23	43220	43220	43220	43220	43220
10	Seal – Inboard Shaft	27	33353	33353	—	—	—
11	Retainer Ring – Wheel Bearing	28	36121	36121	—	—	—
12	Wheel Bearing Assembly	29	565909	565909	565977	565977	565977
13	Seal – Outboard Shaft	30	35938	35938	42914	42914	42914
14	Retainer – Oil Seal	31	42101	42101	—	—	—
15	C – Clip	33	—	—	43221	43221	43221
16	Tone Ring	34	—	—	—	42790	—

Jeep Model 35 /194 Rear Axles Variable Parts Listing

Kits & Parts - Use With All Applications							
Description & Item Number (Refer to "Exploded View")			Bills of Material				
			605455	605475	605483 605484 605485 605500 605502	605507	605525
1	KIT – Carrier Cover	-	73605X	74208X	74208X	74208X	—
2	Pinion Nut	9	42968	43225	43225	43225	43225
3	Plug – Cover	10	43180	41356	41356	41356	41356
4	End Yoke	11	2-4-4601-1	2-4-4601-1	2-4-4601-1	2-4-4601-1	2-4-4601-1
5	Pinion – Differential (std)	19	43719	45787	43719	45787	43719
6	Gear – Differential (std)	20	43718	45786	43718	45786	43718
7	Thrustwasher – Diff Pinion (std)	21	42077	34096	42077	34096	42077
8	Thrustwasher – Diff Gear (std)	22	42078	34095	42078	34095	42078
9	Shaft – Differential (std)	23	43220	44594	43220	44594	43220
10	Seal – Inboard Shaft	27	—	—	—	—	—
11	Retainer Ring – Wheel Bearing	28	—	—	—	—	—
12	Wheel Bearing Assembly	29	565977	565977	565977	565977	565977
13	Seal – Outboard Shaft	30	42914	42914	42914	42914	42914
14	Retainer – Oil Seal	31	—	—	—	—	—
15	C – Clip	33	43221	43221	43221	43221	43221
16	Tone Ring	34	—	44217	—	44217	44217
			605528	605534 605535 605536	605541 605564	605579	605602
1	KIT – Carrier Cover	-	74208X	74208X	74208X	74208X	74208X
2	Pinion Nut	9	43225	43225	43225	43225	43225
3	Plug – Cover	10	41356	41356	41356	41356	41356
4	End Yoke	11	2-4-4601-1	2-4-4601-1	2-4-4601-1	2-4-4601-1	2-4-7661
5	Pinion – Differential (std)	19	45787	43719	43719	45787	46131
6	Gear – Differential (std)	20	45786	43718	73718	45786	46132
7	Thrustwasher – Diff Pinion (std)	21	34096	42077	42077	34096	34096
8	Thrustwasher – Diff Gear (std)	22	34095	42078	42078	34095	34095
9	Shaft – Differential (std)	23	44594	43220	43220	44594	44594
10	Seal – Inboard Shaft	27	—	—	—	—	—
11	Retainer Ring – Wheel Bearing	28	—	—	—	—	—
12	Wheel Bearing Assembly	29	565977	565977	565977	565977	565977
13	Seal – Outboard Shaft	30	42914	42914	42914	42914	42914
14	Retainer – Oil Seal	31	—	—	—	—	—
15	C – Clip	33	43221	43221	43221	43221	43221
16	Tone Ring	34	44217	—	44217	44217	45637

(See next page for additional bills of material)

Jeep Model 35 /194 Rear Axles Variable Parts Listing

Kits & Parts - Use With All Applications							
Description & Item Number (Refer to "Exploded View")			Bills of Material				
			605607	605655 605656	605657 605658 605659	605660	605661
1	KIT – Carrier Cover	-	74208X	74208X	74208X	74208X	74208X
2	Pinion Nut	9	43225	43225	43225	43225	43225
3	Plug – Cover	10	41356	41356	41356	43156	41356
4	End Yoke	11	2-4-7661	2-4-4601-1	2-4-4601-1	2-4-4601-1	2-4-7631-1
5	Pinion – Differential (std)	19	45787	45787	45787	45787	45787
6	Gear – Differential (std)	20	45786	45786	45786	45786	45786
7	Thrustwasher – Diff Pinion (std)	21	34096	34096	34096	34096	34096
8	Thrustwasher – Diff Gear (std)	22	34095	34095	34095	34095	34095
9	Shaft – Differential (std)	23	44594	44594	44594	44594	44594
10	Seal – Inboard Shaft	27	—	—	—	—	—
11	Retainer Ring – Wheel Bearing	28	—	—	—	—	—
12	Wheel Bearing Assembly	29	565977	565977	565977	565977	565977
13	Seal – Outboard Shaft	30	42914	42914	42914	42914	42914
14	Retainer – Oil Seal	31	—	—	—	—	—
15	C – Clip	33	43221	43221	43221	43221	43221
16	Tone Ring	34	45637	—	44217	—	—
			605662	605706 605707	605725	605727	605728 605729
1	KIT – Carrier Cover	-	74208X	74208X	74208X	74208X	74208X
2	Pinion Nut	9	43225	43225	43225	43225	43225
3	Plug – Cover	10	41356	41356	41356	41356	41356
4	End Yoke	11	2-4-7631-1	2-4-4601-1	2-4-4601-1	2-4-7301-1	2-4-7301-1
5	Pinion – Differential (std)	19	45787	45787	45787	45787	45787
6	Gear – Differential (std)	20	45786	45786	45786	45786	45786
7	Thrustwasher – Diff Pinion (std)	21	34096	34096	34096	34096	34096
8	Thrustwasher – Diff Gear (std)	22	34095	34095	34095	34095	34095
9	Shaft – Differential (std)	23	44594	44594	44594	44594	44594
10	Seal – Inboard Shaft	27	—	—	—	—	—
11	Retainer Ring – Wheel Bearing	28	—	—	—	—	—
12	Wheel Bearing Assembly	29	565977	565977	565977	565977	565977
13	Seal – Outboard Shaft	30	42914	42914	42914	42914	42914
14	Retainer – Oil Seal	31	—	—	—	—	—
15	C – Clip	33	43221	43221	43221	43221	43221
16	Tone Ring	34	44217	45637	44217	44217	—

Jeep Model 35 /194 Rear Axles Variable Parts Listing

Kits & Parts - Use With All Applications							
Description & Item Number (Refer to "Exploded View")			Bills of Material				
			605730 605731 605732	605733	605746	605747	605775
1	KIT – Carrier Cover	-	74208X	74208X	74208X	74208X	74208X
2	Pinion Nut	9	43225	43225	43225	43225	43225
3	Plug – Cover	10	41356	41356	41356	41356	41356
4	End Yoke	11	2-4-7301-1	2-4-7301-1	2-4-4601-1	2-4-4601-1	2-4-7631-1
5	Pinion – Differential (std)	19	45787	45787	45787	45787	45787
6	Gear – Differential (std)	20	45786	45786	45786	45786	45786
7	Thrustwasher – Diff Pinion (std)	21	34096	34096	34096	34096	34096
8	Thrustwasher – Diff Gear (std)	22	34095	34095	34095	34095	34095
9	Shaft – Differential (std)	23	44594	44594	44594	44594	44594
10	Seal – Inboard Shaft	27	—	—	—	—	—
11	Retainer Ring – Wheel Bearing	28	—	—	—	—	—
12	Wheel Bearing Assembly	29	565977	565977	565977	565977	565977
13	Seal – Outboard Shaft	30	42914	42914	46485	46485	42914
14	Retainer – Oil Seal	31	—	—	—	—	—
15	C – Clip	33	43221	43221	43221	43221	43221
16	Tone Ring	34	44217	—	44217	—	—
			605776	605797 605798	605893 605894	605895	605909
1	KIT – Carrier Cover	-	74208X	74208X	74208X	74208X	74208X
2	Pinion Nut	9	43225	43225	43225	43225	43225
3	Plug – Cover	10	41356	41356	41356	41356	41356
4	End Yoke	11	2-4-7631-1	2-4-7301-1	2-4-7631-1	2-4-7631-1	2-4-7631-1
5	Pinion – Differential (std)	19	—	45787	—	45787	—
6	Gear – Differential (std)	20	—	45786	—	45786	—
7	Thrustwasher – Diff Pinion (std)	21	—	34096	—	34096	—
8	Thrustwasher – Diff Gear (std)	22	—	34095	—	34095	—
9	Shaft – Differential (std)	23	—	44594	—	44594	—
10	Seal – Inboard Shaft	27	—	—	—	—	—
11	Retainer Ring – Wheel Bearing	28	—	—	—	—	—
12	Wheel Bearing Assembly	29	565977	565977	565977	565977	565977
13	Seal – Outboard Shaft	30	42914	46485	46485	46485	46485
14	Retainer – Oil Seal	31	—	—	—	—	—
15	C – Clip	33	43221	43221	43221	43221	43221
16	Tone Ring	34	—	45637	—	44217	44217

(See next page for additional bills of material)

Jeep Model 35 /194 Rear Axles Variable Parts Listing

Kits & Parts - Use With All Applications							
Description & Item Number (Refer to "Exploded View")			Bills of Material				
			605913	605914	605916	605918	605919
3	KIT – Carrier Cover	-	74208X	74208X	74208X	74208X	74208X
4	Pinion Nut	9	43225	43225	43225	43225	43225
5	Plug – Cover	10	41356	41356	41356	41356	41356
6	End Yoke	11	2-4-7301-1	2-4-7301-1	2-4-7631-1	2-4-7631-1	2-4-7631-1
8	Pinion – Differential (std)	19	—	45787	45787	45787	—
9	Gear – Differential (std)	20	—	45786	45786	45786	—
10	Thrustwasher – Diff Pinion (std)	21	—	34096	34096	34096	—
11	Thrustwasher – Diff Gear (std)	22	—	34095	34095	34095	—
12	Shaft – Differential (std)	23	—	44594	44594	44594	—
13	Seal – Inboard Shaft	27	—	—	—	—	—
14	Retainer Ring – Wheel Bearing	28	—	—	—	—	—
15	Wheel Bearing Assembly	29	565977	565977	565977	565977	565977
16	Seal – Outboard Shaft	30	46485	46485	46485	46485	46485
17	Retainer – Oil Seal	31	—	—	—	—	—
18	C – Clip	33	43221	43221	43221	43221	43221
19	Tone Ring	34	44217	44217	—	44217	44217
			605956	605957	605960 605961	605992	605993
3	KIT – Carrier Cover	-	74208X	74208X	74208X	74208X	74208X
4	Pinion Nut	9	43225	43225	43225	43225	43225
5	Plug – Cover	10	41356	41356	41356	41356	41356
6	End Yoke	11	2-4-4601-1	2-4-4601-1	2-4-7301-1	2-4-7991-1	2-4-7991-1
8	Pinion – Differential (std)	19	45787	45787	45787	45787	45787
9	Gear – Differential (std)	20	45786	45786	45786	45786	45786
10	Thrustwasher – Diff Pinion (std)	21	34096	34096	34096	34096	34096
11	Thrustwasher – Diff Gear (std)	22	34095	34095	34096	34095	34095
12	Shaft – Differential (std)	23	44594	44594	44594	44594	44594
13	Seal – Inboard Shaft	27	—	—	—	—	—
14	Retainer Ring – Wheel Bearing	28	—	—	—	—	—
15	Wheel Bearing Assembly	29	565977	565977	565977	565977	565977
16	Seal – Outboard Shaft	30	46485	46485	46485	46485	46485
17	Retainer – Oil Seal	31	—	—	—	—	—
18	C – Clip	33	43221	43221	43221	43221	43221
19	Tone Ring	34	44217	—	45637	44217	—

Jeep Model 35 /194 Rear Axles Variable Parts Listing

Kits & Parts - Use With All Applications							
Description & Item Number (Refer to "Exploded View")			Bills of Material				
			606031	606032	606033	606034	606035
1	KIT – Carrier Cover	-	74208X	74208X	74208X	74208X	74208X
2	Pinion Nut	9	43225	43225	43225	43225	43225
3	Plug – Cover	10	41356	41356	41356	41356	41356
4	End Yoke	11	2-4-7301-1	2-4-7301-1	2-4-7301-1	2-4-7631-1	2-4-7631-1
5	Pinion – Differential (std)	19	—	45787	45787	45787	—
6	Gear – Differential (std)	20	—	45786	45786	45786	—
7	Thrustwasher – Diff Pinion (std)	21	—	34096	34096	34096	—
8	Thrustwasher – Diff Gear (std)	22	—	34095	34095	34095	—
9	Shaft – Differential (std)	23	—	44594	44594	44594	—
10	Seal – Inboard Shaft	27	—	—	—	—	—
11	Retainer Ring – Wheel Bearing	28	49766	—	—	—	—
12	Wheel Bearing Assembly	29	565977	565977	565977	565977	565977
13	Seal – Outboard Shaft	30	46485	46485	46485	46485	46485
14	Retainer – Oil Seal	31	—	—	—	—	—
15	C – Clip	33	43221	43221	43221	43221	43221
16	Tone Ring	34	44217	44217	—	44217	44217
			606103				
1	KIT – Carrier Cover	-	74208X				
2	Pinion Nut	9	43225				
3	Plug – Cover	10	41356				
4	End Yoke	11	2-4-7631-1				
5	Pinion – Differential (std)	19	—				
6	Gear – Differential (std)	20	—				
7	Thrustwasher – Diff Pinion (std)	21	—				
8	Thrustwasher – Diff Gear (std)	22	—				
9	Shaft – Differential (std)	23	—				
10	Seal – Inboard Shaft	27	—				
11	Retainer Ring – Wheel Bearing	28	—				
12	Wheel Bearing Assembly	29	565977				
13	Seal – Outboard Shaft	30	46485				
14	Retainer – Oil Seal	31	—				
15	C – Clip	33	43221				
16	Tone Ring	34	—				

Jeep / Eagle 1977-1998

Model 44 /216 Rear Axles for

CJ Civilian Jeep

J10 Pick-up Truck

XJ Cherokee /Comanche

YJ /TJ Wagoneer

ZJ Grand Cherokee

Jeep 44 /216 Rear Axles Exploded View

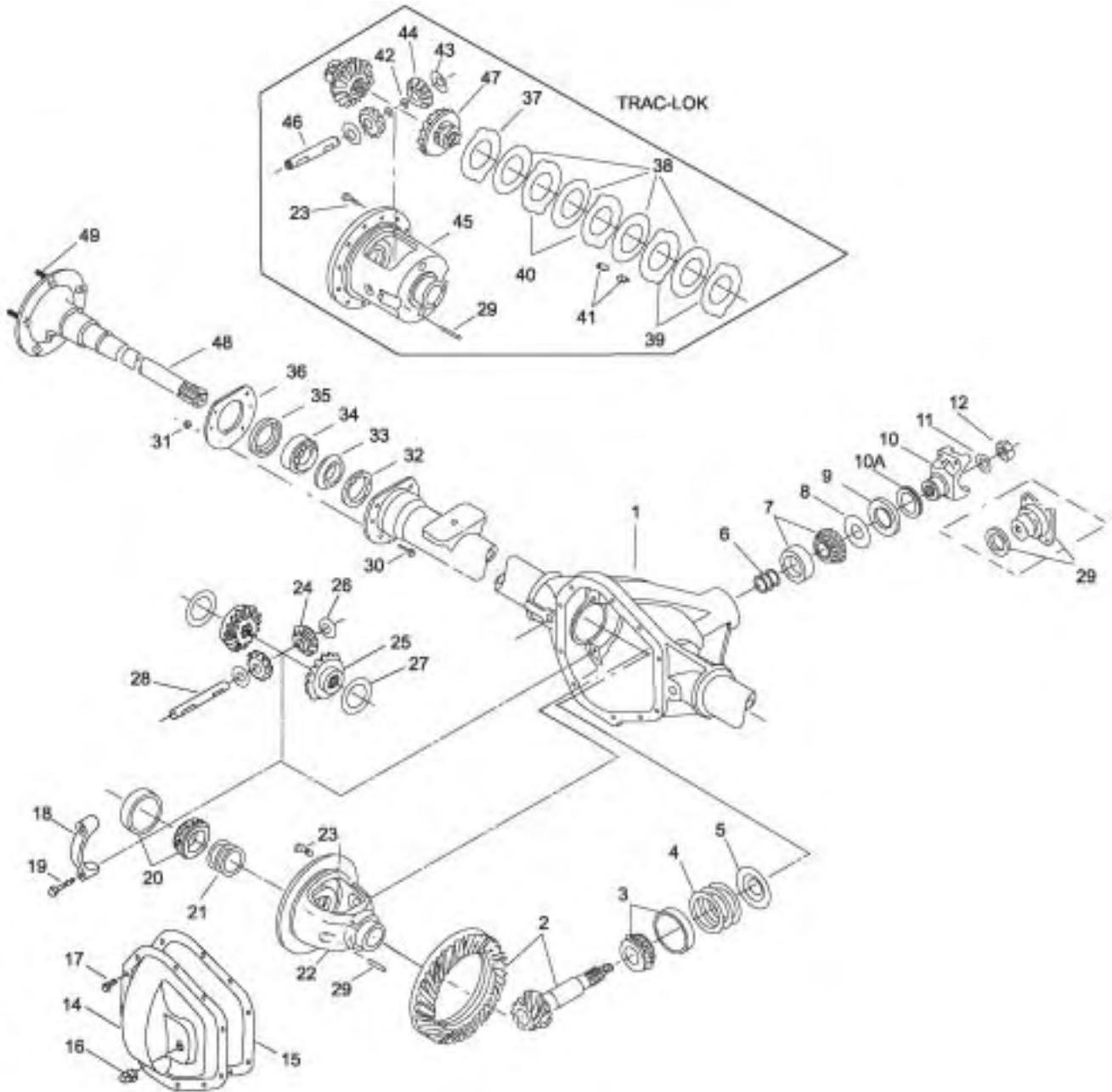

Jeep 44 /216 Rear Axles Parts Listing

ITEM NO.	PART NUMBER	DESCRIPTION	ITEM NO.	PART NUMBER	DESCRIPTION
1	— ⁽³⁾	Housing – Axle Service	23	41221	Bolt – Drive Gear (qty 10)
2	— ⁽¹⁾	Drive Pinion & Gear Assembly	24	— ⁽²⁾	Pinion – Differential (std)
3	706031X	KIT – Inner Pinion Bearing	25	— ⁽²⁾	Gear – Differential (std)
4	—	Inner Pinion Bearing Shims (see shim packages)	26	13338-3	Thrustwasher – Diff Pinion (std)
5	— ⁽²⁾	Baffle – Pinion Bearing	27	32121	Thrustwasher – Diff Gear (std)
	706376X	PKG – Diff & Pinion Bearing Shim (inc items 4, 6, 11, 12, 15, 21)	28	39194	Shaft – Differential (std)
6	—	Outer Pinion Bearing Shims (see shim packages)	29	13449	Lock – Differential Shaft (std or t/l)
	706358X	PKG – Pinion Bearing Shim (inc items 4, 6, 11, 12, 15)	30	— ⁽³⁾	Bolt – Brake Mounting
7	706030X	KIT – Outer Pinion Bearing	31	— ⁽³⁾	Nut – Brake Mounting
8	13575	Slinger – Pinion Bearing Outer		— ⁽²⁾	KIT – Unit Bearing and Seal (inc items 32, 33, 34, 35, 36)
9	— ⁽²⁾	Seal – Pinion Oil	32	— ⁽²⁾	Seal – Inboard Shaft
10	— ⁽²⁾	End Yoke or Assembly (inc 10A)	33	36797	Retainer Ring – Wheel Bearing
10A	— ⁽²⁾	Slinger – End Yoke	34	565903	Wheel Bearing Assembly
11	30186	Washer – Pinion Nut	35	35239	Seal – Outboard Shaft
12	30185	Pinion Nut	36	— ⁽²⁾	Retainer – Oil Seal
13	— ⁽³⁾	Companion Flange Assembly		706352X	KIT – Diff Plate and Disc (t/l) (inc items 37, 38, 39, 40, 41)
	— ⁽²⁾	KIT – Carrier Cover (inc items 14, 15, 16, 17)	37	— ⁽⁴⁾	Plate – Preload Spacer
14	— ⁽²⁾	Carrier Cover	38	— ⁽⁴⁾	Disc – Differential
15	— ⁽²⁾	Gasket/RTV Silicone Sealant	39	— ⁽⁴⁾	Plate – Differential
16	— ⁽²⁾	Plug – Carrier Cover	40	— ⁽⁴⁾	Plate – Differential Pressure
17	34279	Bolt – Carrier Cover (qty 10)	41	40835	Clip – Differential Clutch Retainer
18	— ⁽³⁾	Differential Bearing Cap	42	35660	Snap Ring (as needed)
19	48632-1	Bolt – Differential Bearing Cap	43	13338-3	Thrustwasher – Diff Pinion (t/l)
20	706032X	KIT – Differential Bearing	44	32808	Pinion – Differential (t/l)
21	706086X	PKG – Diff Bearing Shim (inc 15)	45	— ⁽⁴⁾	Case – Differential (t/l)
22	— ⁽⁴⁾	Case – Differential (std)	46	— ⁽²⁾	Shaft – Differential (t/l)
			47	35657	Gear – Differential (t/l)
			48	— ⁽¹⁾	Shaft – Axle Flange Drive
			49	— ⁽²⁾	Bolt – Wheel

- (1) See "Bill of Material Table" on next page
(2) See "Variable Parts Table" within this section
(3) Contact Vehicle Manufacturer
(4) Not Sold Separately

Jeep 44 /216 Rear Axles Bill of Material Table

Axle			Axle Kits				Shaft & Joint Assy.	
Bill of Material	Diff. Type	Ratio	Ring Gear & Pinion Kit ⁽⁷⁾	Differential			Right Hand Shaft Assy.	Left Hand Shaft Assy.
				Case Assy. Kit ⁽⁸⁾	Case Kit	Inner Parts Kit		
1977-79 Cherokee Chief (STD Transfer Case)								
603815-1	Standard	3.54	706017-3X	706020X	706024X	706027X	28497-1X	28497-4X
603815-2	Standard	4.09	706017-5X	706021X	706025X	706027X	28497-1X	28497-4X
603815-3	Trac Lok	4.09	706017-5X	707150X	707151X	706026X	28497-1X	28497-4X
603815-4	Trac Lok	3.54	706017-3X	707115X	707116X	706026X	28497-1X	28497-4X
1977-79 Wagoneer & Cherokee (STD Transfer Case)								
603816-1	Standard	3.07	706017-1X	706020X	706024X	706027X	28497-1X	28497-2X
603816-2	Trac Lok	3.07	706017-1X	707115X	707116X	706026X	28497-1X	28497-2X
603816-3	Standard	3.54	706017-3X	706020X	706024X	706027X	28497-1X	28497-2X
603816-4	Trac Lok	3.54	706017-3X	707115X	707116X	706026X	28497-1X	28497-2X
603816-5	Standard	4.09	706017-5X	706021X	706025X	706027X	28497-1X	28497-2X
603816-6	Trac Lok	4.09	706017-5X	707150X	707151X	706026X	28497-1X	28497-2X
1977-79 Wagoneer & Cherokee (Quadra-Trac Transfer Case)								
603817-1	Standard	3.07	706017-1X	706020X	706024X	706027X	28497-3X	28497-4X
603817-2	Standard	3.54	706017-3X	706020X	706024X	706027X	28497-3X	28497-4X
603817-3	Standard	4.09	706017-5X	706021X	706025X	706027X	28497-3X	28497-4X
603817-4	Standard	2.72	706017-19X	706020X	706024X	706027X	28497-3X	28497-4X
1977-79 Cherokee Chief Quadra-Trac								
603818-1	Standard	3.54	706017-3X	706020X	706024X	706027X	28497-1X	28497-4X
603818-2	Standard	4.09	706017-5X	706021X	706025X	706027X	28497-1X	28497-4X
603818-3	Standard	4.09	706017-1X	706020X	706024X	706027X	28497-1X	28497-4X
1977-80 Post Office Dispatcher								
603820-1	Trac Lok	3.07	706017-1X	707115X	707116X	706026X	26762-22X	26762-21X
603820-2	Trac Lok	3.31	706017-2X	707115X	707116X	706026X	26762-22X	26762-21X
603820-3	Trac Lok	3.73	706017-4X	707115X	707116X	706026X	26762-22X	26762-21X
1979 J10 & Honcho Truck								
603941-1	Standard	3.54	706017-3X	706020X	706024X	706027X	28497-7X	28497-4X
603941-2	Trac Lok	3.54	706017-3X	707115X	707116X	706026X	28497-7X	28497-4X
603941-3	Standard	4.07	706017-5X	706021X	706025X	706027X	28497-7X	28497-4X
603941-4	Trac Lok	4.07	706017-5X	707150X	707151X	706026X	28497-7X	28497-4X
603941-5	Standard	3.07	706017-1X	706020X	706024X	706027X	28497-7X	28497-4X
603941-6	Trac Lok	3.07	706017-1X	707115X	707116X	706026X	28497-7X	28497-4X
1982-84 CJ10								
605103-1	Standard	3.73	706017-4X	706020X	706024X	706027X	28497-5X	28497-14X
605103-2	Trac Lok	4.89	706017-7X	707150X	707151X	706026X	28497-5X	28497-14X
605103-3	Standard	4.09	706017-5X	706021X	706025X	706027X	28497-5X	28497-14X
605103-4	Trac Lok	4.09	706017-5X	707150X	707151X	706026X	28497-5X	28497-14X
1985 CJ10								
605236-1	Standard	3.73	706017-4X	706020X	706024X	706027X	28497-5X	28497-14X
605236-2	Trac Lok	4.89	706017-7X	707150X	707151X	706026X	28497-5X	28497-14X
605236-3	Standard	4.09	706017-5X	706021X	706025X	706027X	28497-5X	28497-14X
605236-4	Trac Lok	4.09	706017-5X	707150X	707151X	706026X	28497-5X	28497-14X
1986 Grand Wagoneer								
605285-1	Standard	3.31	706017-2X	707045X	706024X	707047X	28497-8X	28497-9X
605285-2	Standard	2.72	706017-19X	707045X	706024X	707047X	28497-8X	28497-9X
605285-3	Trac Lok	3.31	706017-2X	707115X	707116X	706026X	28497-8X	28497-9X
605285-4	Trac Lok	2.72	706017-19X	707115X	707116X	706026X	28497-8X	28497-9X

(7) See Ring Gear & Pinion Kits in XGI Catalog for ratio & tooth combinations.

(8) See Differential Case Assy Kits in XGI Catalog for spline data & ratios.

Jeep 44 /216 Rear Axles Bill of Material Table

Axle			Axle Kits				Shaft & Joint Assy.	
Bill of Material	Diff. Type	Ratio	Ring Gear & Pinion Kit ⁽⁷⁾	Differential			Right Hand Shaft Assy.	Left Hand Shaft Assy.
				Case Assy. Kit ⁽⁸⁾	Case Kit	Inner Parts Kit		
1986 J10 Pickup								
605286-1	Standard	3.31	706017-2X	707045X	706024X	707047X	28497-12X	28497-13X
605286-2	Standard	2.72	706017-19X	707045X	706024X	707047X	28497-12X	28497-13X
605286-3	Trac Lok	3.31	706017-2X	707115X	707116X	706026X	28497-12X	28497-13X
1986 XJ Metric Ton Truck								
605287-1	Standard	3.54	706017-3X	707045X	706024X	707047X	73499-1X	73499-2X
605287-2	Standard	4.09	706017-5X	707046X	706025X	707047X	73499-1X	73499-2X
605287-4	Trac Lok	3.54	706017-3X	707115X	707116X	706026X	73499-1X	73499-2X
605287-5	Trac Lok	4.09	706017-5X	707150X	707151X	706026X	73499-1X	73499-2X
1986 CJ7								
605289-1	Standard	2.72	706017-19X	707045X	706024X	707047X	72903-1X	72903-2X
605289-3	Standard	3.31	706017-2X	707045X	706024X	707047X	72903-1X	72903-2X
605289-4	Trac Lok	3.31	706017-2X	707115X	707116X	706026X	72903-1X	72903-2X
605289-5	Standard	3.54	706017-3X	707045X	706024X	707047X	72903-1X	72903-2X
605289-7	Standard	4.09	706017-5X	707046X	706025X	707047X	72903-1X	72903-2X
605289-8	Trac Lok	4.09	706017-5X	707150X	707151X	706026X	72903-1X	72903-2X
605289-9	Standard	4.55	706017-6X	707046X	706025X	707047X	72903-1X	72903-2X
605289-10	Trac Lok	4.55	706017-6X	707150X	707151X	706026X	72903-1X	72903-2X
1987-87 1/2 XJ Utility								
605342-1	Standard	3.07	706017-1X	707045X	706024X	707047X	73499-1X	73499-2X
605342-2	Trac Lok	3.07	706017-1X	707115X	707116X	706026X	73499-1X	73499-2X
605342-3	Standard	3.54	706017-3X	707045X	706024X	707047X	73499-1X	73499-2X
605342-4	Trac Lok	3.54	706017-3X	707115X	707116X	706026X	73499-1X	73499-2X
605342-5	Standard	3.55	706017-3X	707045X	706024X	707047X	73499-1X	73499-2X
605342-6	Trac Lok	3.55	706017-3X	707115X	707116X	706026X	73499-1X	73499-2X
1987-88 J10 Pickup								
605330-1	Standard	3.31	706017-2X	707045X	706024X	707047X	28497-12X	28497-13X
605330-2	Standard	2.72	706017-19X	707045X	706024X	707047X	28497-12X	28497-13X
605330-3	Trac Lok	3.31	706017-2X	707115X	707116X	706026X	28497-12X	28497-13X
1987-92 Grand Wagoneer								
605329-1	Standard	3.31	706017-2X	707045X	706024X	707047X	28497-8X	28497-9X
605329-2	Standard	2.72	706017-19X	707045X	706024X	707047X	28497-8X	28497-9X
605329-3	Trac Lok	3.31	706017-2X	707115X	707116X	706026X	28497-8X	28497-9X
605329-4	Trac Lok	2.72	706017-19X	707115X	707116X	706026X	28497-8X	28497-9X
605329-5	Trac Lok	3.31	706017-2X	707115X	707116X	707099X	28497-8X	28497-9X
605329-6	Trac Lok	2.72	706017-19X	707115X	707116X	707099X	28497-8X	28497-9X

(7) See Ring Gear & Pinion Kits in XGI Catalog for ratio & tooth combinations.

(8) See Differential Case Assy Kits in XGI Catalog for spline data & ratios.

Jeep 44 /216 Rear Axles Bill of Material Table

Axle			Axle Kits				Shaft & Joint Assy.	
Bill of Material	Diff. Type	Ratio	Ring Gear & Pinion Kit ⁽⁷⁾	Differential			Right Hand Shaft Assy.	Left Hand Shaft Assy.
				Case Assy. Kit ⁽⁸⁾	Case Kit	Inner Parts Kit		
1987-93 1/2 XJ Metric Ton Truck, XJ HD Truck								
605325-1	Standard	3.54	706017-3X	707045X	706024X	707047X	73499-1X	73499-2X
605325-2	Standard	4.09	706017-5X	707046X	706025X	707047X	73499-1X	73499-2X
605325-3	Standard	3.07	706017-1X	707045X	706024X	707047X	73499-1X	73499-2X
605325-4	Trac Lok	3.07	706017-1X	707115X	707116X	706026X	73499-1X	73499-2X
605325-5	Trac Lok	3.54	706017-3X	707115X	707116X	706026X	73499-1X	73499-2X
605325-6	Standard	3.55	706017-3X	707045X	706024X	707047X	73499-1X	73499-2X
605325-7	Trac Lok	3.55	706017-3X	707115X	707116X	706026X	73499-1X	73499-2X
605325-8	Trac Lok	3.07	706017-1X	707115X	707116X	707099X	73499-1X	73499-2X
605325-9	Trac Lok	3.54	706017-3X	707115X	707116X	707099X	73499-1X	73499-2X
605325-10	Standard	3.54	706017-3X	707045X	706024X	707047X	73499-1X	73499-2X
605325-11	Standard	4.09	706017-5X	707046X	706025X	707047X	73499-1X	73499-2X
605325-12	Standard	3.07	706017-1X	707045X	706024X	707047X	73499-1X	73499-2X
605325-13	Trac Lok	3.07	706017-1X	707115X	707116X	707099X	73499-1X	73499-2X
605325-14	Trac Lok	3.54	706017-3X	707115X	707116X	707099X	73499-1X	73499-2X
605325-15	Trac Lok	4.09	706017-5X	707150X	707151X	707099X	73499-1X	73499-2X
1988 1/2-96 1/2 YJ								
605339-3	Trac Lok	3.07	706017-1X	707115X	707116X	706026X	73499-1X	73499-2X
605339-4	Standard	3.54	706017-3X	707045X	706024X	707047X	73499-1X	73499-2X
605339-5	Trac Lok	3.54	706017-3X	707115X	707116X	706026X	73499-1X	73499-2X
605339-6	Standard	4.09	706017-5X	707046X	706025X	707047X	73499-1X	73499-2X
605339-7	Trac Lok	4.09	706017-5X	707150X	707151X	707099X	73499-1X	73499-2X
605339-8	Trac Lok	3.07	706017-1X	707115X	707116X	706026X	73499-1X	73499-2X
605339-9	Trac Lok	3.54	706017-3X	707115X	707116X	707099X	73499-1X	73499-2X
1997 TJ NON ABS								
605849-2	Trac Lok	3.55	75861-5X	707115X	707116X	707099X	75786-1X	75786-2X
605849-3	Trac Lok	4.10	74720-5X	707115X	707116X	707099X	75786-1X	75786-2X
1997 TJ RHD, NON ABS								
605952-1	Trac Lok	3.07	706017-1X	707115X	707116X	707099X	75786-1X	75786-2X
605952-3	Trac Lok	4.10	74720-5X	707115X	707116X	707099X	75786-1X	75786-2X
605952-4	Trac Lok	3.73	706017-4X	707115X	707116X	707099X	75786-1X	75786-2X
1997 1/2-99 TJ RHD, NON ABS								
606016-1	Trac Lok	3.07	706017-1X	707115X	707116X	707099X	75786-1X	75786-2X
606016-4	Trac Lok	3.73	706017-4X	707115X	707116X	707099X	75786-1X	75786-2X
1998-99 TJ NON ABS								
606015-2	Trac Lok	3.55	75861-5X	707115X	707116X	707099X	75786-1X	75786-2X
606015-4	Trac Lok	3.73	706017-4X	707115X	707116X	707099X	75786-1X	75786-2X

(7) See Ring Gear & Pinion Kits in XGI Catalog for ratio & tooth combinations.

(8) See Differential Case Assy Kits in XGI Catalog for spline data & ratios.

Jeep 44 /216 Rear Axles Variable Parts Listing

Kits & Parts - Use With All Applications							
Description & Item Number (Refer to "Exploded View")			Bills of Material				
			603815 603816	603817 603818	603820	603941	605103 605236
1	Baffle – Pinion Bearing	5	30765	30765	30765	30765	30765
2	Seal – Pinion Oil	9	39118	39118	39118	39118	39118
3	End Yoke or Assembly (inc 10A)	10	—	2-4-2281X	2-4-2281X	2-4-2281X	2-4-8091-1X
4	Slinger – End Yoke	10A	15099	15099	15099	15099	41498
5	KIT – Carrier Cover	-	706692X	706691X	706627X	706691X	706694X
6	Carrier Cover	14	39006	39007	39015	39007	18433
7	Gasket/RTV Silicone Sealant	15	38615	38615	38615	38615	38615
8	Plug – Carrier Cover	16	37580	37580	38637	37580	36472
9	Pinion – Differential (std)	24	17717	17717	—	17717	17717
10	Gear – Differential (std)	25	40194	40194	—	40194	40194
11	KIT – Unit Bearing and Seal	-	706517X	706517X	706012X	706517X	706517X
12	Seal – Inboard Shaft	32	34419	34419	34419	34419	34419
13	Retainer – Oil Seal	36	39156	39156	39155	39156	39156
14	Shaft – Differential (t/l)	46	35659	—	35659	35659	35659
15	Bolt – Wheel	49	38899	38899	38899	38899	38899
			605285	605286	605287	605289	605325
1	Baffle – Pinion Bearing	5	30765	30765	30765	30765	30765
2	Seal – Pinion Oil	9	39118	39118	39118	39118	44895
3	End Yoke or Assembly (inc 10A)	10	2-4-8091-1X	2-4-8091-1X	2-4-8091-1X	2-4-8091-1X	2-4-6561-1
4	Slinger – End Yoke	10A	41498	41498	41498	41498	—
5	KIT – Carrier Cover	-	706694X	707110X	707110X	707110X	707110X
6	Carrier Cover	14	18433	42960-1	42960-1	42960-1	42960-1
7	Gasket/RTV Silicone Sealant	15	38615	—	—	—	—
8	Plug – Carrier Cover	16	36472	43180	43180	43180	43180
9	Pinion – Differential (std)	24	42243	42243	42243	42243	42243
10	Gear – Differential (std)	25	45870	45870	45870	45870	45870
11	KIT – Unit Bearing and Seal	-	706517X	706517X	706500X	706500X	706500X
12	Seal – Inboard Shaft	32	—	—	—	—	—
13	Retainer – Oil Seal	36	39156	39156	35916	35916	35916
14	Shaft – Differential (t/l)	46	35659	35659	35659	35659	35659
15	Bolt – Wheel	49	38899	38899	42048	35491	32983
			605329 605330	605339 605342	605849 605952	606015	606016
1	Baffle – Pinion Bearing	5	30765	30765	—	—	—
2	Seal – Pinion Oil	9	44895	44895	44895	44895	44895
3	End Yoke or Assembly (inc 10A)	10	2-4-6781-1	2-4-6561-1	2-4-6561-1	2-4-8141-1	2-4-8141-1
4	Slinger – End Yoke	10A	—	—	—	—	—
5	KIT – Carrier Cover	-	707110X	707110X	707110X	707110X	707110X
6	Carrier Cover	14	42960-1	42960-1	42960-1	42960-1	42960-1
7	Gasket/RTV Silicone Sealant	15	—	—	—	—	—
8	Plug – Carrier Cover	16	43180	43180	43180	43180	43180
9	Pinion – Differential (std)	24	42243	42243	—	—	—
10	Gear – Differential (std)	25	45870	45870	—	—	—
11	KIT – Unit Bearing and Seal	-	706517X	706500X	707374-1X	707374-1X	707374-1X
12	Seal – Inboard Shaft	32	—	—	—	—	—
13	Retainer – Oil Seal	36	39156	35916	47160	47160	47160
14	Shaft – Differential (t/l)	46	35659	35659	39194	39194	39194
15	Bolt – Wheel	49	38899	32983	32983	38899	32983

Jeep / Eagle 1996-1999

Model 44 /216 Rear Axles for

ZJ Grand Cherokee

Jeep Model 44 /216 Rear for Grand Cherokee Exploded View

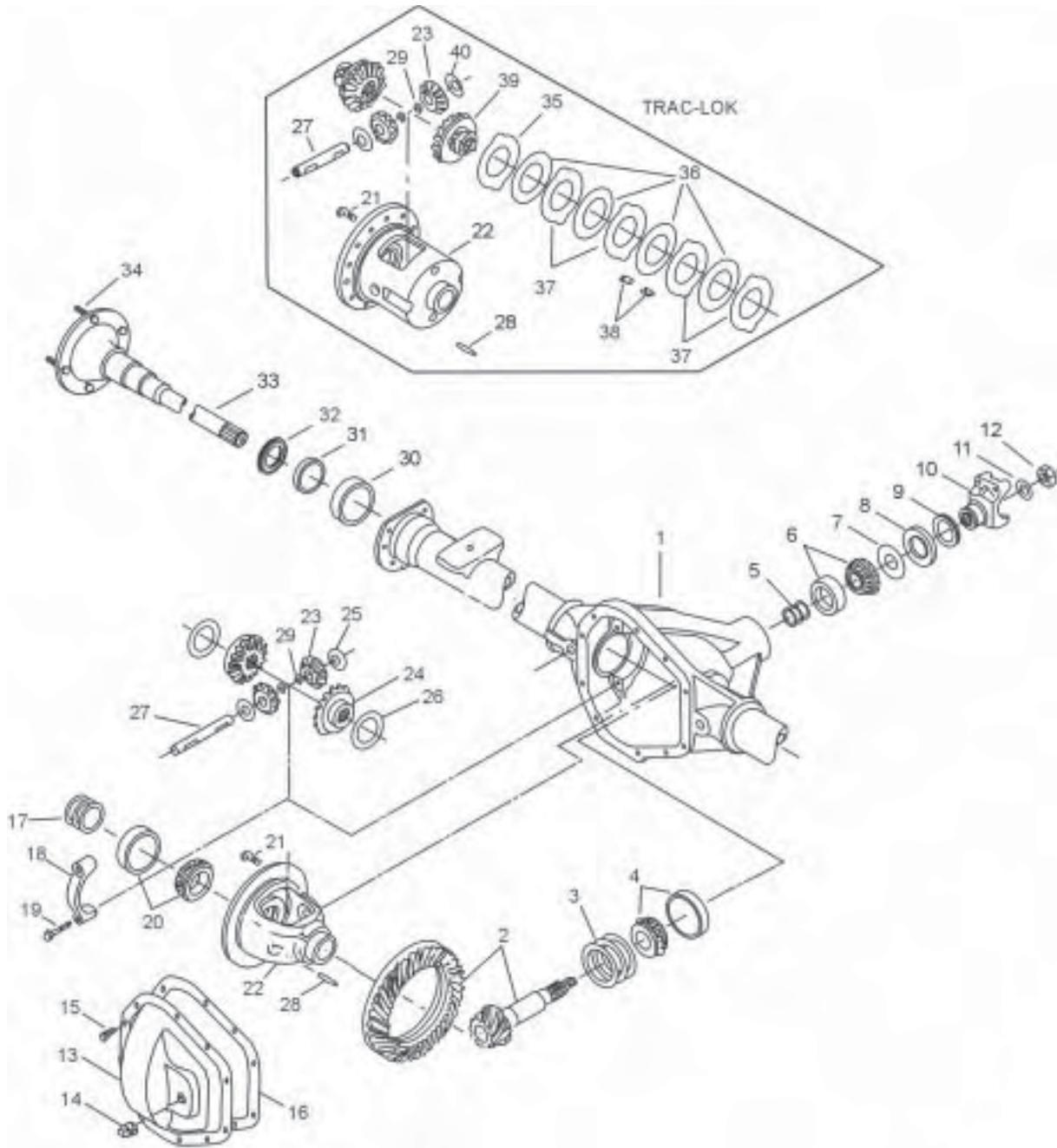

Jeep Model 44 /216 Rear for Grand Cherokee

Parts Listing

ITEM NO.	PART NUMBER	DESCRIPTION	ITEM NO.	PART NUMBER	DESCRIPTION
1	— ⁽³⁾	Housing – Axle Service		702005-6	Diff Shim Pkg (.141 – .145)
2	— ⁽¹⁾	Drive Pinion & Gear Assembly		702005-7	Diff Shim Pkg (.147 – .155)
3	—	Inner Pinion Bearing Shims	18	— ⁽³⁾	Differential Bearing Cap
	72922-2X	PKG-Pinion Adj Shim (.035 - .039)	19	41212	Bolt – Differential Bearing Cap
	72922-3X	PKG-Pinion Adj Shim (.040 - .044)	20	706988X	KIT – Differential Bearing
	72922-4X	PKG-Pinion Adj Shim (.045 - .049)	21	41221	Bolt – Drive Gear
	72922-5X	PKG-Pinion Adj Shim (.050 - .054)	22	— ⁽⁴⁾	Case – Differential
4	707064X	KIT – Inner Pinion Bearing	23	43809	Pinion – Differential
5	43916	Collapsible Spacer	24	44270	Gear – Differential (std)
6	706123X	KIT – Outer Pinion Bearing	25	46948	Thrustwasher – Differential Pinion
7	42737	Thrustwasher	26	32121	Thrustwasher – Differential Gear
8	42449	Oil Seal	27	43764	Shaft – Differential Gear
9	34592	Slinger – End Yoke	28	43765	Pin – Differential
10	— ⁽²⁾	End Yoke Assembly (inc 9)	29	44281	Retainer – Axle Shaft
11	30275	Washer – Pinion Nut	30	566121	Wheel Bearing Assembly
12	30271	Pinion Nut	31	46485	Oil Seal
	75478X	Carrier Cover Assy (inc 13,14,15)	32	45637	Tone Ring (ABS)
13	46590-1	Carrier Cover	33	— ⁽¹⁾	Axle Shaft
14	41356	Plug – Carrier Cover	34	45712-1	Bolt – Axle Shaft
15	34279	Bolt – Carrier Cover (qty 10)		707018X	KIT – Differential Plate & Disc (t/l)
16	38615	RTV Silicone Sealant			(inc items 35, 36, 37, 38)
		PKG – Diff & Pinion Bearing Shim	35	— ⁽⁴⁾	Plate – Preload Spacer
17	702005-1	Diff Shim Pkg (.111 – .119)	36	— ⁽⁴⁾	Disc – Differential
	702005-2	Diff Shim Pkg (.121 – .125)	37	— ⁽⁴⁾	Plate – Differential Pressure
	702005-3	Diff Shim Pkg (.126 – .130)	38	40835	Clip – Differential Clutch Retainer
	702005-4	Diff Shim Pkg (.131 – .135)	39	44271	Gear – Differential (t/l)
	702005-5	Diff Shim Pkg (.136 – .140)	40	43810	Thrustwasher Pinion (t/l)

(1) See "Bill of Material Table" on next page

(2) See "Variable Parts Table" within this section

(3) Contact Vehicle Manufacturer

(4) Not Sold Separately

Jeep Model 44 /216 Rear for Grand Cherokee

Bill of Material Table

Axle			Axle Kits				Shaft & Joint Assy.	
Bill of Material	Diff. Type	Ratio	Ring Gear & Pinion Kit ⁽⁷⁾	Differential			Right Hand Shaft Assy.	Left Hand Shaft Assy.
				Case Assy. Kit ⁽⁸⁾	Case Kit	Inner Parts Kit		
1996-99 ZJ ABS								
605735-1	Standard	3.55	707381-3X	707382X	43771	707384X	74871-1X	74871-2X
605735-2	Trac Lok	3.73	707381-4X	707383X	43775	707385X	74871-1X	74871-2X
605735-3	Standard	3.73	707381-4X	707382X	43771	707384X	74871-1X	74871-2X
605735-4	Trac Lok	3.55	707381-3X	707383X	43775	707385X	74871-1X	74871-2X
1997-98 1/2 ZJ ABS								
605962-1	Standard	3.55	707381-3X	707382X	43771	707384X	74871-1X	74871-2X
605962-2	Trac Lok	3.73	707381-4X	707383X	43775	707385X	74871-1X	74871-2X
605962-3	Standard	3.73	707381-4X	707382X	43771	707384X	74871-1X	74871-2X
605962-4	Trac Lok	3.55	707381-3X	707383X	43775	707385X	74871-1X	74871-2X
1998-98 1/2 ZJ ABS								
606046-1	Trac Lok	3.73	707381-4X	707383X	43775	707385X	74871-1X	74871-2X
606047-1	Trac Lok	3.73	707381-4X	707383X	43775	707385X	74871-1X	74871-2X

(7) See Ring Gear & Pinion Kits in XGI Catalog for ratio & tooth combinations.

(8) See Differential Case Assy Kits in XGI Catalog for spline data & ratios.

Variable Parts Listing

Kits & Parts - Use With All Applications						
Description & Item Number (Refer to "Exploded View")			Bills of Material			
			605735 605962	606046 606047		
1	End Yoke Assembly (inc 9)		10	2-4-6551-1X	2-4-4291-1X	

Jeep / Eagle 1978-1988

Model 60 /248 Rear Axles for

**CJ10 Civilian Jeep
J20 Pick-up Truck**

Jeep Model 60 /248 Rear Exploded View

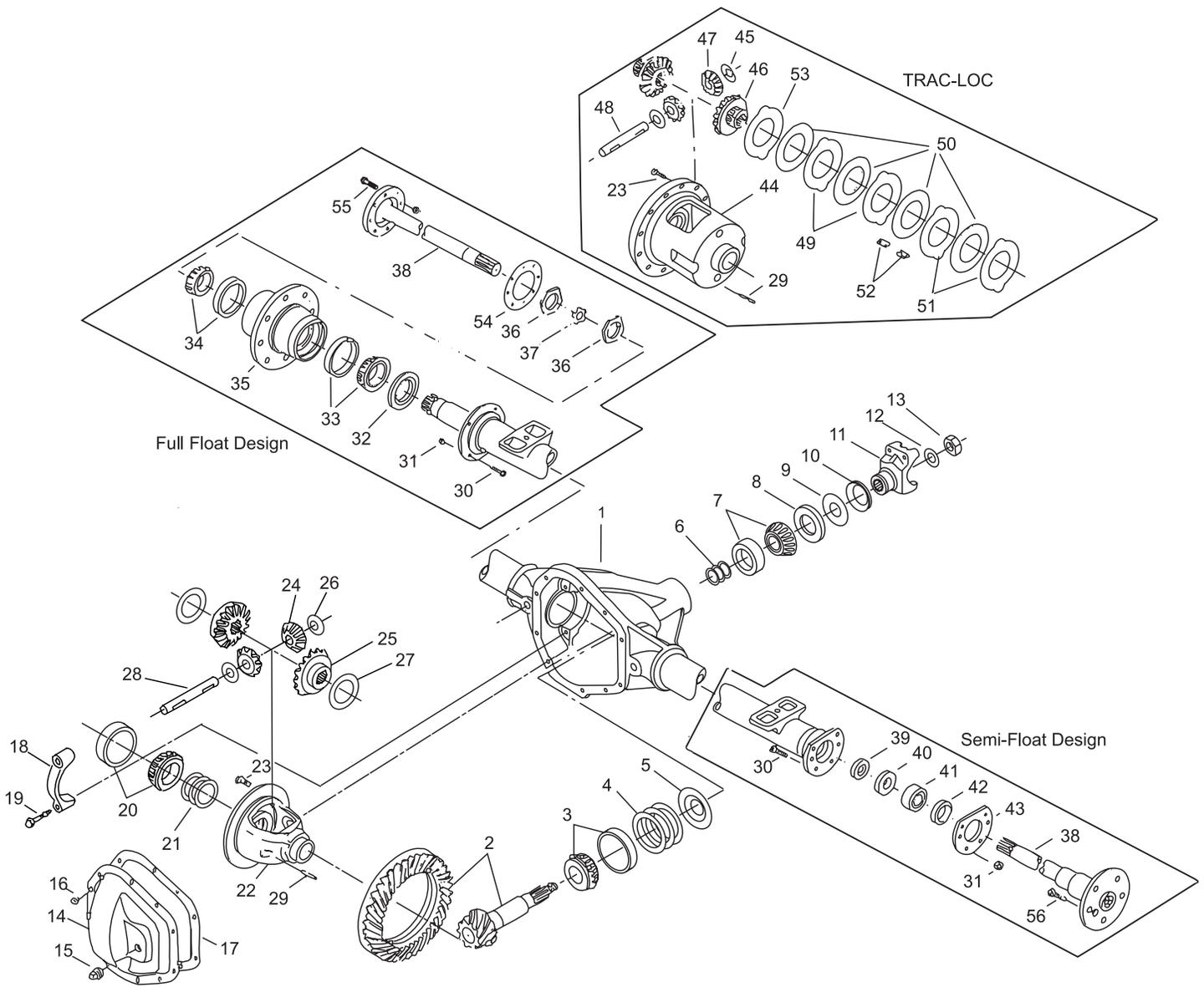

Jeep Model 60 /248 Rear Parts Listing

ITEM NO.	PART NUMBER	DESCRIPTION	ITEM NO.	PART NUMBER	DESCRIPTION
1	— ⁽³⁾	Housing – Axle Service	27	34729	Thrustwasher – Diff Gear (std)
2	— ⁽¹⁾	Drive Pinion & Gear Assembly	28	30263	Shaft – Differential (std)
3	706046X	KIT – Inner Pinion Bearing	29	44810	Lock – Differential Shaft
	708020	PKG – Diff & Pinion Bearing Shim (inc items 4, 6, 12, 17, 21)	30	— ⁽³⁾	Bolt – Brake Mounting
	706359X	PKG – Pinion Bearing Shim (inc items 4, 6, 12, 17)	31	— ⁽³⁾	Nut – Brake Mounting
4	—	Inner Pinion Bearing Shims (see shim packages)	32	35697	Hub Seal
5	30982	Baffle – Pinion Bearing	33	706557X	KIT – Inner Wheel Bearing
6	—	Outer Pinion Bearing Shims (see shim packages)	34	706217X	KIT – Outer Wheel Bearing
7	706045X	KIT – Outer Pinion Bearing	35	— ⁽³⁾	Wheel Hub
8	42737	Thrustwasher	36	30636	Spindle Nut
9	42449	Seal – Pinion Oil	37	30637	Lockwasher – Spindle Nut
10	34592	Slinger – End Yoke	38	— ⁽¹⁾	Shaft – Axle Flanged Drive
11	— ⁽²⁾	End Yoke Assembly (inc 10)		— ⁽²⁾	KIT – Unit Bearing & Seal (inc items 39, 40, 41, 42, 43)
12	30275	Washer – Pinion Nut	39	35512	Seal – Inboard Shaft
13	30271	Pinion Nut	40	35961	Retainer Ring – Wheel Bearing
	— ⁽²⁾	KIT – Carrier Cover (inc items 14, 15, 16)	41	565904	Wheel Bearing Assembly
14	— ⁽²⁾	Carrier Cover	42	35511	Seal – Outboard Shaft
15	43180	Plug – Carrier Cover	43	— ⁽²⁾	Oil Seal Retainer
16	34822	Bolt – Carrier Cover (qty 10)	44	— ⁽⁴⁾	Case – Differential (t/l)
17	34687	Gasket – Carrier Cover	45	34730	Thrustwasher – Diff Pinion (t/l)
18	— ⁽³⁾	Differential Bearing Cap	46	— ⁽²⁾	Gear – Differential (t/l)
19	48632-1	Bolt – Differential Bearing Cap	47	34367	Pinion – Differential (t/l)
20	706047X	KIT – Differential Bearing	48	30263	Shaft – Differential
21	708012	PKG – Diff Bearing Shim (inc 17)		707083X	KIT – Differential Plate & Disc (t/l) (inc items 49, 50, 51, 52, 53)
22	— ⁽⁴⁾	Case – Differential (std)	49	— ⁽⁴⁾	Plate – Differential Pressure (t/l)
23	30266	Bolt – Drive Gear (qty 12)	50	— ⁽⁴⁾	Disc – Differential (t/l)
24	34367	Pinion – Differential (std)	51	— ⁽⁴⁾	Plate – Differential
25	— ⁽²⁾	Gear – Differential (std)	52	40835	Clip – Diff Clutch Retainer (t/l)
26	34730	Thrustwasher – Diff Pinion (std)	53	— ⁽⁴⁾	Spacer – Plate Preload
			54	35374	Gasket
			55	—	Bolt – Axle Shaft (Full Float)
			56	38899	Bolt – Axle Shaft (Semi Float)

- (1) See "Bill of Material Table" on next page
(2) See "Variable Parts Table" within this section
(3) Contact Vehicle Manufacturer
(4) Not Sold Separately

Jeep Model 60 /248 Rear Bill of Material Table

Axle			Axle Kits				Shaft & Joint Assy.	
Bill of Material	Diff. Type	Ratio	Ring Gear & Pinion Kit ⁽⁷⁾	Differential			Right Hand Shaft Assy.	Left Hand Shaft Assy.
				Case Assy. Kit ⁽⁸⁾	Case Kit	Inner Parts Kit		
1978-79 J20 Pickup								
603930-1	Standard	3.73	706033-2X	706036X	706040X	706043X	31494-8	31494-9
603930-2	Standard	4.10	706033-3X	706036X	706040X	706043X	31494-8	31494-9
603930-3	Standard	3.54	706033-1X	706036X	706040X	706043X	31494-8	31494-9
1979 J20 Pickup								
603470-1	Standard	4.10	706033-3X	706036X	706040X	706043X	31494-5	31494-6
603470-2	Standard	4.88	706033-5X	706037X	706041X	706043X	31494-5	31494-6
603470-3	Trac Lok	4.10	706033-3X	708013	708014	707084X	31494-5	31494-6
603470-4	Trac Lok	4.88	706033-5X	707097X	706039X	707084X	31494-5	31494-6
603470-5	Trac Lok	3.73	706033-2X	708013	708014	707084X	31494-5	31494-6
603470-6	Standard	3.73	706033-2X	706036X	706040X	706043X	31494-5	31494-6
603470-7	Trac Lok	3.54	706033-1X	708013	708014	707084X	31494-5	31494-6
603470-8	Standard	3.54	706033-1X	706036X	706040X	706043X	31494-5	31494-6
1980-81 1/2 J20 Pickup								
603980-1	Trac Lok	4.88	706033-5X	707097X	706039X	707084X	31494-10	31494-10
603980-2	Standard	4.10	706033-3X	706036X	706040X	706043X	31494-10	31494-10
603980-3	Trac Lok	4.10	706033-3X	708013	708014	707084X	31494-10	31494-10
603980-4	Standard	3.73	706033-2X	706036X	706040X	706043X	31494-10	31494-10
603980-5	Trac Lok	3.73	706033-2X	708013	708014	707084X	31494-10	31494-10
603980-6	Standard	3.54	706033-1X	706036X	706040X	706043X	31494-10	31494-10
603980-7	Trac Lok	3.54	706033-1X	708013	708014	707084X	31494-10	31494-10
1982-85 J20 Pickup								
605079-1	Trac Lok	4.88	706033-5X	707097X	706039X	707084X	31494-10	31494-10
605079-4	Standard	3.73	706033-2X	706036X	706040X	706043X	31494-10	31494-10
605079-5	Trac Lok	3.73	706033-2X	708013	708014	707084X	31494-10	31494-10
1982 1/2-84 CJ10								
605104-1	Standard	4.10	706033-3X	706180X	706040X	706702X	71667-1X	71667-2X
605104-2	Trac Lok	4.10	706033-3X	707090-4X	708014	707086X	71667-1X	71667-2X
605104-3	Trac Lok	4.88	706033-5X	707097-4X	706039X	707086X	71667-1X	71667-2X
1985 AM 720								
605196-1	Trac Lok	4.88	706033-5X	707097X	706039X	707084X	31494-10	31494-10
1985 CJ10								
605237-1	Standard	4.10	706033-3X	706180X	706040X	706702X	71667-1X	71667-2X
605237-2	Trac Lok	4.10	706033-3X	707090-4X	708014	707086X	71667-1X	71667-2X
605237-3	Trac Lok	4.88	706033-5X	707097-4X	706039X	707086X	71667-1X	71667-2X
1986-88 J20 Pickup								
605291-1	Trac Lok	4.88	706033-5X	707097X	706039X	707084X	31494-10	31494-10
605291-4	Standard	3.73	706033-2X	706036X	706040X	706043X	31494-10	31494-10
605291-5	Trac Lok	3.73	706033-2X	708013	708014	707084X	31494-10	31494-10

(7) See Ring Gear & Pinion Kits in XGI Catalog for ratio & tooth combinations.
(8) See Differential Case Assy Kits in XGI Catalog for spline data & ratios.

Jeep Model 60 /248 Rear Variable Parts Listing

Kits & Parts - Use With All Applications							
Description & Item Number (Refer to "Exploded View")			Bills of Material				
			603470	603930	603980 605079	605104	605196
1	End Yoke Assembly (inc 10)	11	2-4-3801X	2-4-3801X	2-4-3801-1X	2-4-3801-1X	2-4-3801-1X
2	KIT – Carrier Cover	-	707108X	707108X	707108X	707106X	707106X
3	Carrier Cover	14	42799-2	42799-2	42799-2	42799-1	42799-1
4	Gear – Differential (std)	25	34394	34394	34394	35625	—
5	KIT – Unit Bearing & Seal	-	—	—	—	706904X	—
6	Oil Seal Retainer	43	—	—	—	40355	—
7	Gear – Differential (t/l)	46	35803	—	35803	35830	35803
			605237	605291			
1	End Yoke Assembly (inc 10)	11	2-4-3801-1X	2-4-3801-1X			
2	KIT – Carrier Cover	-	707108X	707108X			
3	Carrier Cover	14	42799-2	42799-2			
4	Gear – Differential (std)	25	35625	34394			
5	KIT – Unit Bearing & Seal	-	706904X	—			
6	Oil Seal Retainer	43	40355	—			
7	Gear – Differential (t/l)	46	35830	35803			

Jeep / Eagle 1985

Model 70 /267 Rear Axles for

CJ10A Military Jeep

Jeep Model 70 /267 Rear Exploded View

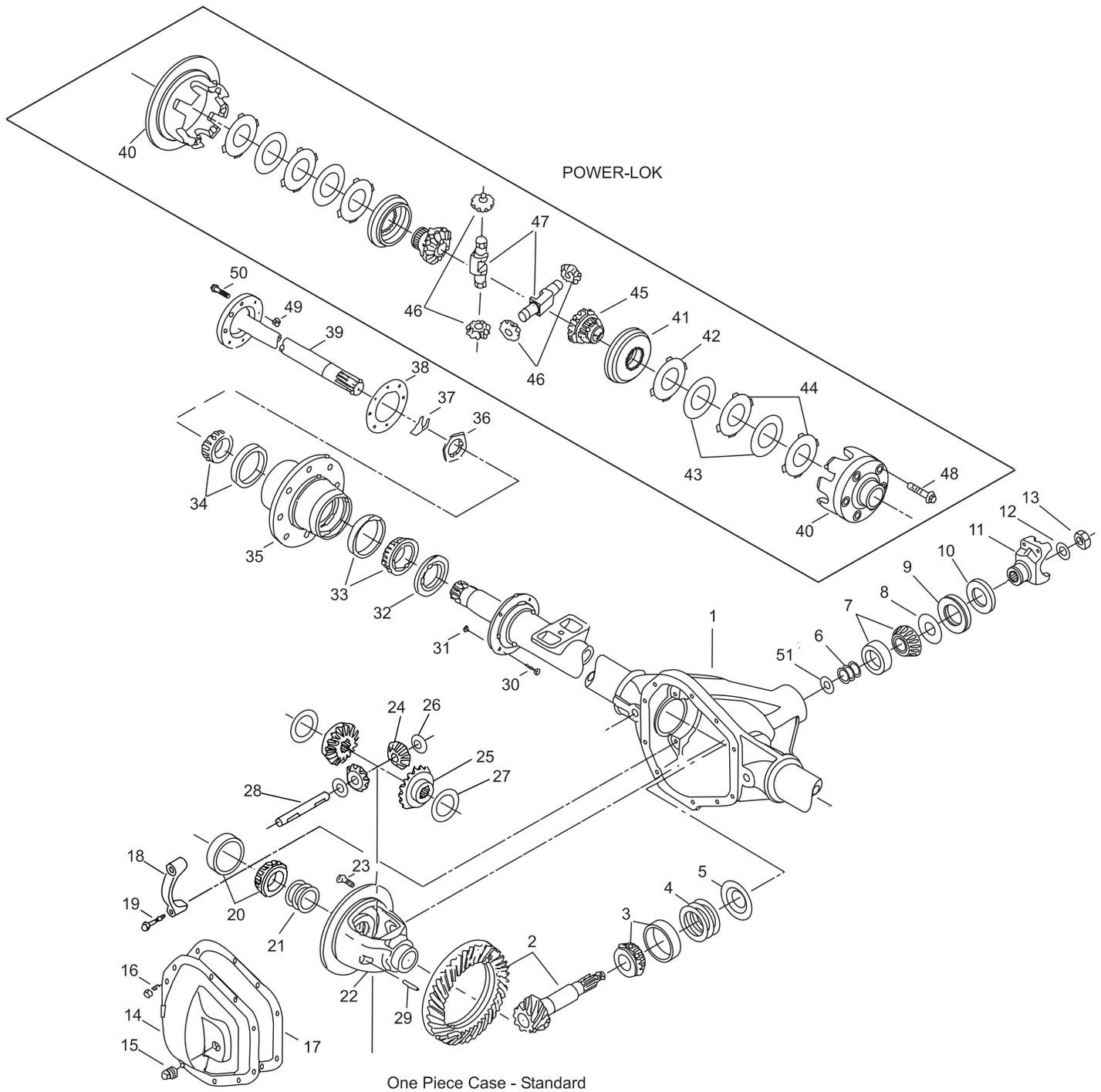

Jeep Model 70 /267 Rear Parts Listing

ITEM NO.	PART NUMBER	DESCRIPTION	ITEM NO.	PART NUMBER	DESCRIPTION
1	— ⁽³⁾	Housing – Axle Service	24	35080	Pinion – Differential (std)
2	706998-5X	Drive Pinion & Gear Assembly	25	35079	Gear – Differential (std)
3	706861X	KIT – Inner Pinion Bearing	26	35082	Thrustwasher – Diff Pinion (std)
4	—	Inner Pinion Bearing Shims (see shim packages)	27	34729	Thrustwasher – Diff Gear (std)
	706862X	PKG – Pinion Bearing Shim (inc items 4, 6, 12, 13)	28	46640	Shaft – Differential (std)
5	41550	Baffle – Pinion Bearing	29	47024	Lock – Differential Shaft
6	—	Outer Pinion Bearing Shims (see shim packages)	30	— ⁽³⁾	Bolt – Brake Mounting
	708020	KIT – Diff & Pinion Bearing Shim (inc items 4, 6, 13, 17, 21)	31	— ⁽³⁾	Nut – Brake Mounting
7	706045X	KIT – Outer Pinion Bearing	32	39693	Seal – Hub
8	42737	Thrustwasher – Bearing	33	— ⁽³⁾	KIT – Inner Wheel Bearing
9	42449	Seal – Pinion Oil	34	— ⁽³⁾	KIT – Outer Wheel Bearing
10	34592	Slinger – End Yoke	35	— ⁽³⁾	Wheel Hub
11	2-4-3801-1X	End Yoke Assembly (inc 10)	36	39695	Spindle Nut
12	30275	Washer – Pinion Nut	37	41373	Locking Wedge
13	30271	Pinion Nut	38	39697	Gasket
	707104X	KIT – Carrier Cover (inc items 14, 15, 16)	39	— ⁽¹⁾	Shaft – Axle Flange Drive
14	42815-2	Carrier Cover	40	— ⁽⁴⁾	Case – Differential (p/l)
15	43180	Plug – Carrier Cover	41	42522	Ring – Differential Gear
16	34822	Bolt – Carrier Cover (qty 10)	42	— ⁽⁴⁾	KIT – Differential Plate & Disc (p/l) (inc items 43, 44, 45)
17	34687	Gasket – Carrier Cover	43	— ⁽⁴⁾	Plate – Differential
18	— ⁽³⁾	Differential Bearing Cap	44	43161	Disc – Differential(dished)
19	48632-1	Bolt – Differential Bearing Cap	45	— ⁽⁴⁾	Friction Modifier
20	706047X	KIT – Differential Bearing	46	35294	Plate – Differential
21	708012	KIT – Diff Bearing Shim (inc 17)	47	31040	Gear – Differential(p/l)
22	— ⁽⁴⁾	Case – Differential (std)	48	31041	Pinion – Differential (p/l)
23	30266	Bolt – Drive Gear (qty 12)	49	41610-1	Shaft – Differential (p/l)
			50	36526	Bolt – Differential Case
			51	39694	Lockwasher
				46176	Bolt – Axle Shaft
					Spacer – Flat

- (1) See "Bill of Material Table" below
- (3) Contact Vehicle Manufacturer
- (4) Not Sold Separately

Bill of Material Table

Axle			Axle Kits				Shaft & Joint Assy.	
Bill of Material	Diff. Type	Ratio	Ring Gear & Pinion Kit ⁽⁷⁾	Differential			Right Hand Shaft Assy.	Left Hand Shaft Assy.
				Case Assy. Kit ⁽⁸⁾	Case Kit	Inner Parts Kit		
1985 CJ 10A Military								
605242-1	Powr Lok	4.88	706998-5X	706050X	706054X	706057X	36113-25	36113-24
605242-2	Standard	4.88	706998-5X	706052X	706056X	706058X	36113-25	36113-24

- (7) See Ring Gear & Pinion Kits in XGI Catalog for ratio & tooth combinations.
- (8) See Differential Case Assy Kits in XGI Catalog for spline data & ratios.



Dana Corporation
Heavy Vehicle Technologies &
Systems Service
PO Box 321
Toledo, Ohio 43697-0321
1-800-SAY-DANA (729-3262)

Dana Corporation
Heavy Vehicle Technologies &
Systems Service - Canada
5095 South Service Road
Beamsville, Ontario LOR 1B0
Tech Service: (905) 563-4991

Dana Corporation
Heavy Vehicle Technologies &
Systems Service - International
(419) 861-6325

www.dana.com
www2.dana.com/expert

