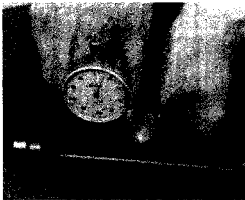
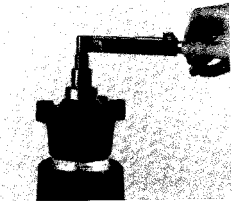
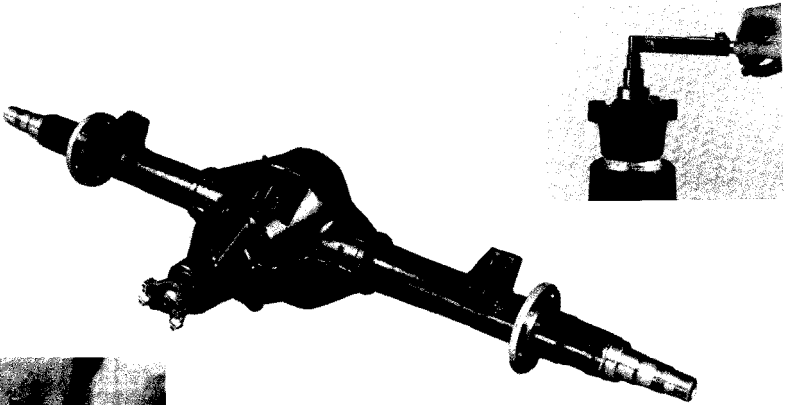


# MODEL 80

## SINGLE-SPEED AXLE



# MAINTENANCE

# MANUAL

**SPICER®**



Dana Corporation, Spicer Axle Division, reserves the right to make changes from time to time, without notice or obligations, in specifications, descriptions, and illustrations, and to discontinue models or revise designs.

Questions regarding this manual should be directed to:

Spicer Axle Division  
Dana Corporation  
P.O. Box #1209  
Fort Wayne, IN 46801  
Attn: Engineering Technical  
Service Department



**WE SUPPORT  
VOLUNTARY TECHNICIAN  
CERTIFICATION THROUGH**

National Institute for  
**AUTOMOTIVE  
SERVICE  
EXCELLENCE**

# INDEX

## SECTION 1 GENERAL INFORMATION

	PAGE
Important Safety Notice .....	1-1
Safety Precautions .....	1-2
Axle Identification .....	1-3
Servicing Components Not Covered In This Manual .....	1-3
Vehicle Storage or Prolonged Inoperation .....	1-3
Exploded View of Axle Assembly .....	1-4
Parts Description .....	1-4

## SECTION 2 SERVICE TOOLS

Procurement .....	2-1
Service Tool Part Numbers and Description .....	2-1

## SECTION 3 CARRIER SECTION - SERVICE PROCEDURES

Disassembly .....	3-1
Ring Gear Removal .....	3-2
Servicing Standard Differential Case Assembly .....	3-2
Case Disassembly .....	3-2
Case Reassembly .....	3-3
Drive Pinion Removal .....	3-4
Ring Gear & Pinion Gear Assembly (Theory) .....	3-5
Establishing Pinion Gear Depth Using Service Tool Gages .....	3-6
Assembly of Differential .....	3-11
Worksheet for Calculating Ring Gear Backlash & Differential	
Bearing Preload Shims .....	3-13
Applying RTV Silicone Gasket Sealer to Cover Plate .....	3-15

## SECTION 4 SPECIFICATIONS

Differential Lubrication .....	4-1
Axle Lubricant Change Schedule .....	4-1

<b>Wheel Bearing Lubrication</b> .....	<b>4-1</b>
<b>Submersion or Deep Water Fording</b> .....	<b>4-1</b>
<b>RTV Silicone Rubber Sealer Specification</b> .....	<b>4-2</b>
<b>Fastener Strength Identification</b> .....	<b>4-2</b>
<b>Wrench Tightening Torque Specifications</b> .....	<b>4-3</b>
<b>Pinion Bearing and Differential Bearing Preload Specification</b> .....	<b>4-3</b>
<b>Backlash Specification-Drive Gear to Drive Pinion</b> .....	<b>4-3</b>
<b>Drive Pinion Gear Depth Specification</b> .....	<b>4-3</b>
<b>Wheel Bearing Specification</b> .....	<b>4-3</b>

# SECTION 1

## GENERAL INFORMATION

### IMPORTANT SAFETY NOTICE

Should an axle assembly require component parts replacement, it is recommended that "Original Equipment" replacement parts be used. They may be obtained through your local service dealer or other original equipment manufacturer parts supplier. **CAUTION: THE USE OF NON-ORIGINAL EQUIPMENT REPLACEMENT PARTS IS NOT RECOMMENDED AS THEIR USE MAY CAUSE UNIT FAILURE AND/ OR AFFECT VEHICLE SAFETY.**

Proper service and repair is important to the safe, reliable operation of all motor vehicles or driving axles whether they be front or rear. The service procedures recommended and described in this service manual are effective methods for performing service operations. Some of these service operations require the use of tools specially designed for the purpose. The special tool should be used when and as recommended.

**CAUTION: EXTREME CARE SHOULD BE EXERCISED WHEN WORKING ON COMPONENTS UTILIZING SNAP RINGS OR SPRING LOADED RETENTION DEVICES. FOR PERSONAL SAFETY, IT IS RECOMMENDED THAT INDUSTRIAL STRENGTH SAFETY GOGGLES OR GLASSES BE WORN WHENEVER REPAIR WORK IS BEING DONE ON ANY VEHICLE OR VEHICLE COMPONENTS.**

It is impossible to know, evaluate and advise the service trade of all conceivable ways in which service might be done or of the possible hazardous consequences of each way.

Accordingly, anyone who uses a service procedure or tool which is not recommended must first satisfy himself thoroughly that neither his safety or vehicle safety will be jeopardized by the service methods he selects.

#### WARNING

Some vehicle manufacturers may require the assembly of brake components on Dana axles that utilize materials containing asbestos fibers.

**BREATHING ASBESTOS DUST MAY BE HAZARDOUS TO YOUR HEALTH AND MAY CAUSE SERIOUS RESPIRATORY OR OTHER BODILY HARM.**

Follow O.S.H.A. standards for proper protective devices to be used when working with asbestos materials.

#### SILICONE RUBBER SEALANT (RTV) AND LUBRICATING GREASE AND OILS

Silicone rubber sealant is used as a gasket material on Dana axles, as well as various lubricants for lubricating purposes. Before using any of these materials, one should become familiar with and follow all safety precautions as recommended by the product manufacturer/supplier. All personnel involved with these materials should follow good industrial hygiene practices (e.g. before eating, hands and face should be thoroughly washed. Eating, drinking and smoking should be prohibited in areas where there is potential for significant exposure to these materials).

When discarding any of the materials, observe all local, state, and federal laws and regulations for proper disposal procedures.

# Safety Precautions



This symbol warns of possible personal injury.



A serious or fatal injury can occur...

- if you lack proper training
- if you fail to follow proper procedures
- if you do not use proper tools and safety equipment
- if you assemble components improperly
- if you use incompatible components
- if you use worn-out or damaged components
- if you use components in a non-approved application



**SAFETY GLASSES SHOULD BE WORN AT ALL TIMES WHEN WORKING ON VEHICLES OR VEHICLE COMPONENTS.**

## AXLE IDENTIFICATION

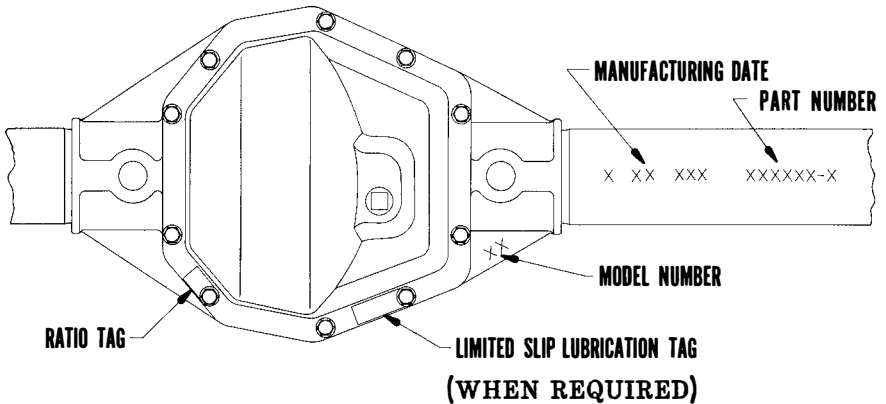


Figure 1-1

Spicer axles are identified with a manufacturing date and complete part numbers stamped on the right-hand tube. The part number may also appear on a metal tag attached to the cover plate by the cover screws, depending upon the requirements of the vehicle manufacturer.

The part number, consisting of six digits reading from left to right, is the basic number for identifying the particular axle assembly. The seventh digit following the dash will identify ratio, differential, and end yoke options used in the assembly. The next group of numbers is the manufacturing date of the axle and is interpreted as follows. The first number is the month, the second number is the day of the month, the third number is the year, the fourth is the line that built the axle, and the letter is the shift.

### NOTE

It is recommended that when referring to the axle, the complete part number and build date be obtained. To do this, it may be necessary to wipe or scrape off dirt, etc., from the axle housing.

If the axle is unique on design such that the unit cannot be identified in the standard manner as described above, refer to the vehicle manufacturer's service and/or parts manual for proper identification.

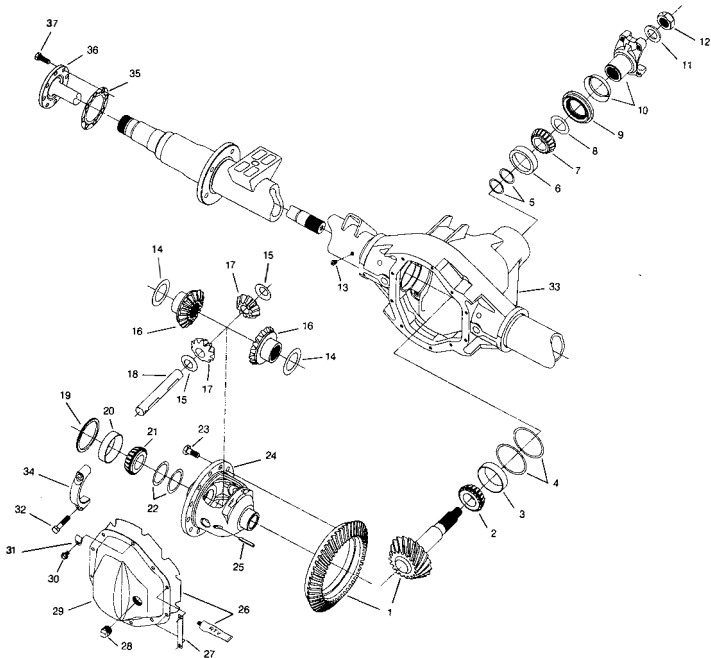
## SERVICING COMPONENTS NOT COVERED IN THIS MANUAL

Service procedures for some components may not be covered in this manual because they are unique to the vehicle application. Refer to the vehicle manufacturer's service manual for servicing those components. (e.g. brakes, hubs, rotors, and wheel end components).

## VEHICLE STORAGE OR PROLONGED INOPERATION

If the vehicle has not been operated on a regular daily basis, it is recommended that the vehicle be operated at least once every two weeks. The vehicle should be moved far enough to cause the drivetrain components to make several complete revolutions. This procedure will help assure that all internal components receive adequate amount of lubrication to help reduce component deterioration caused by an undesirable environment (e.g. high humidity).

## EXPLODED VIEW OF AXLE ASSEMBLY



**Figure 1-2**

The model 80 single-speed axle assembly is an integral-type housing. Shown in figure 1-2 is a Model 80 full-float design.

Item	Part Description
1	Ring Gear and Drive Pinion Assembly
2	Inner Pinion Bearing Cone
3	Inner Pinion Bearing Cup
4	Pinion Position Shims
5	Pinion Bearing Preload Shims
6	Outer Pinion Bearing Cup
7	Outer Pinion Bearing Cone
8	Thrust Washer
9	Pinion Seal
10	End Yoke and Flinger Assembly
11	Washer
12	Nut
13	Shipping Plug (Shipping purposes only - Removed by vehicle manufacturer)
14	Side Gear Thrust Washer
15	Pinion Mate Gear Thrust Washer
16	Differential Side Gear
17	Differential Pinion Mate Gear
18	Differential Pinion Mate Shaft
19	Differential Outboard Spacer
20	Differential Bearing Cup

Item	Part Description
21	Differential Bearing Cone
22	Differential Bearing Preload and Backlash Shims
23	Ring Gear Screw
24	Differential Case
25	Roll Pin (Pinion Mate Shaft)
26	RTV Sealant
*27	Identification Tag
28	Fill Plug
29	Cover Plate
30	Cover Screw
31	Brake Line Clip
32	Differential Bearing Cap Screw
33	Housing
**34	Differential Bearing Cap
35	Gasket-Axle Shaft Flange
36	Axle Shaft
*37	Screw - Axle Shaft Flange

\*Specified by vehicle manufacturer.  
 \*\*Differential bearing caps are part of the housing and cannot be serviced separately.



## SECTION 2

# SERVICE TOOLS

## PROCUREMENT

Throughout the manual reference is made to certain tool numbers whenever special tools are required. These tool numbers are numbers of Miller Special Tools, 32615 Park Lane, Garden City, MI 48135. They are used herein for customer convenience only. Dana makes no warranty or representation to these tools.

Miller Tool Number	Description	Miller Tool Number	Description
D-167	Spreader	C-4307	Cup Remover (Outer pinion bearing)
D-128	Dial Indicator Set	C-4308	Cup Installer (Outer pinion bearing)
DD-914	Press	C-4204	Cup Installer (Inner pinion bearing)
DD-914-8	Adapter Ring	D-389	Bearing Cone Installer (Inner pinion bearing)
DD-914-99	Adapters (Differential bearing cone removal)	*D-116-2	Master Discs (2 each set)
DD-914-95	Adapters (Inner pinion bearing cone removal)	*D-115-3	Arbor
DD-914-7	Extension	*D-116-1	Pinion Height Block
DD-914-42	Button	*D136/D346	Master Differential Bearings (2 each set)
D-189	Holding Wrench (End yoke)	*D-391	Master Pinion Bearing
L-4534	End Yoke Remover	**D-115	Scooter Gage
D-131	Slide Hammer		
D-191	End Yoke Installer		
D-187-A	Pinion Seal Installer		
C-4190	Installer (Differential bearing cones)		
C-4171	Universal Handle		
D-159	Cup Remover (Inner pinion bearing)		

\*Gage set for setting differential bearing preload, gear backlash, and pinion position.  
\*\*Consist of D-106-5 dial indicator and D-115-2 scooter block.

## MISCELLANEOUS TOOLS

Miller Tool Number	Description
C-193	Torque Wrench (0-50 in. Lbs.)
C-524-A	Torque Wrench (0-100 Ft. Lbs.)
C-4053	Torque Wrench (0-300 Ft. Lbs.)
DD-994	Torque Wrench (0-1000 Ft. Lbs.)
#TM-1000-F	Torque Multiplier (4 x 1)

# The TM-1000-F multiplier increases torque (4 to 1) by means of gear ratio. ½" drive (female), ¾" drive (male).

## NOTES

## SECTION 3 CARRIER SECTION

### DISASSEMBLY

#### NOTE

The photos or pictures contained herein are for illustrative and instructional purposes only. The appearance of your axle assembly and/or components may vary from that shown. However, the service procedures described will apply.

If it becomes necessary to disassemble any parts inside the carrier, it is suggested that the entire axle be removed from the vehicle and held tight in a stand or rack.

All dimensions are in inches unless otherwise stated. Dimensions in parentheses followed by mm are in millimeters.

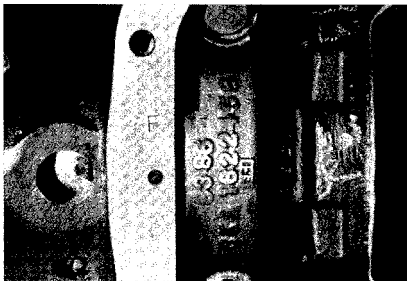


**WARNING:** When removing axle assembly, make sure vehicle is properly supported. Improperly supported vehicle can cause serious injury or death. Follow vehicle manufacturers recommendations for proper axle assembly removal procedures.

*Step (1)* Remove cover plate from housing and drain lubricant.

#### NOTE

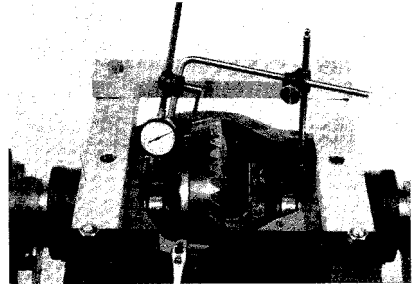
Before removing differential case assembly, make sure the axle shafts are pulled out far enough for clearance to allow removal.



**Figure 3-1**

*Step (2)* Remove bearing caps. Note mating letters stamped on caps and carrier. This is important at time of assembly as they are to be assembled exactly

as removed. Letters or numbers are in vertical and horizontal position.

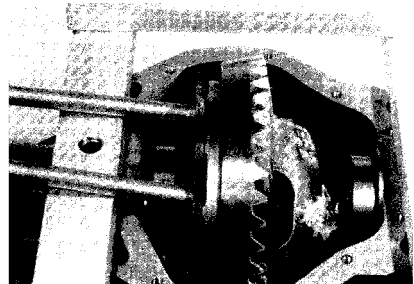


**Figure 3-2**

*Step (3)* Mount spreader to housing. DO NOT SPREAD CARRIER OVER .015 (.38 mm). Use dial indicator as shown.

TOOLS: D-167 Spreader

D-128 Dial Indicator Set

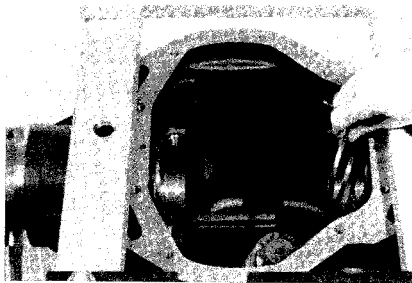


**Figure 3-3**

*Step (4)* Pry differential case from carrier with two pry bars. After differential case has been removed, remove spreader. Use caution to avoid damage to components. Tag bearing cups indicating from which side they were removed from. See note below regarding the use of bearings.

#### NOTE

It is recommended that whenever bearings are removed, they are to be replaced with new ones, regardless of mileage.

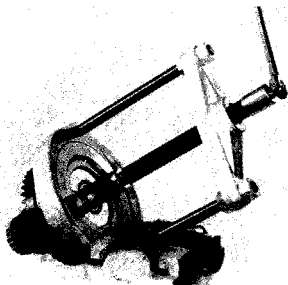


**Figure 3-4**

*Step (5)* Note the differential bearing outboard spacers located on each side of the differential bearing bore. Remove and tag which side they were removed from. Ring gear side or opposite side. They will be reused during assembly, unless damaged or worn.

**NOTE**

Check outboard spacers for damage. (e.g. bent, or deep grooves caused by worn bearings). If damaged, they should be replaced with new ones at time of reassembly.



**Figure 3-5**

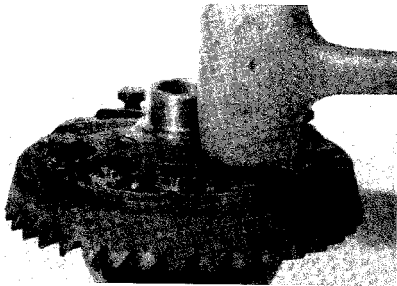
*Step (6)* Remove differential bearing cones with a puller as shown. Tag cones indicating from which side they were removed from.

- TOOLS:** DD-914 Press  
 DD-914-99 Adapters  
 DD-914-8 Adapter Ring  
 DD-914-7 Extension  
 DD-914-42 Button



**WARNING:** When pulling bearings, do not allow differential assembly to fall. It can strike legs or feet and may cause serious injury.

**RING GEAR REMOVAL**



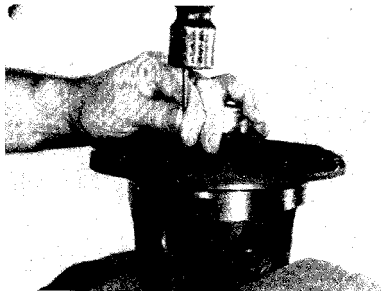
**Figure 3-6**

*Step (7)* Place differential case in vise or suitable holding fixture. Remove ring gear screws. Leave 4 screws loosely assembled 90 degrees apart. Place assembly on a solid bench. Tap screws alternately and evenly to free ring gear from differential case. Remove screws and ring gear. Discard ring gear screws. Ring gear screws are to be replaced with new ones at time of reassembly.

**SERVICING STANDARD DIFFERENTIAL CASE ASSEMBLY**

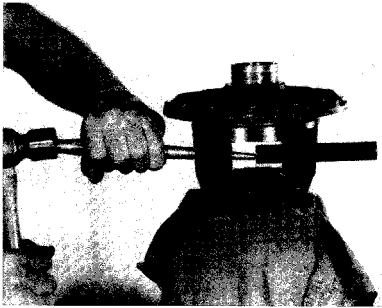
The differential assembly may be serviced at this time, if required. If differential case, side gears and pinion mate gears are useable and do not require servicing, proceed to DRIVE PINION REMOVAL.

**CASE DISASSEMBLY**



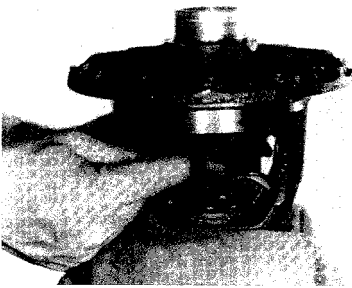
**Figure 3-7**

*Step (8)* Remove roll pin with a small drift.



**Figure 3-8**

*Step (9)* Remove differential pinion mate shaft with drift.



**Figure 3-9**

*Step (10)* Rotate gears until the pinion mate (small gears) enter the large opening of the case. Remove pinion mate gears and spherical washers. After removal of the pinion mate gears, the side gear and thrust washers can be easily removed.

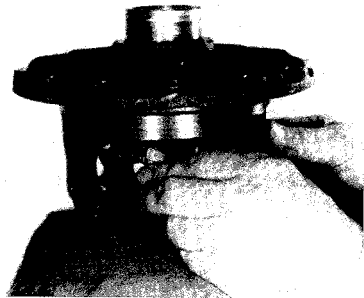
*Step (11)* Inspect and replace components as required.

**NOTE**

Always replace gears as a complete set. Do not mix new gears with old gears, as this may cause uneven wear and short gear life.

**CASE REASSEMBLY**

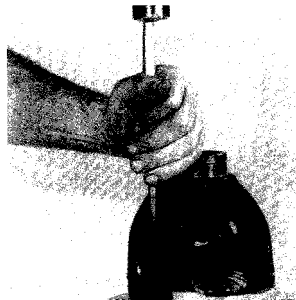
*Step (12)* Apply a small amount of grease on both side gear hubs. Assemble new thrust washers onto side gears.



**Figure 3-10**

*Step (13)* Assemble both side gears into case. Hold top side gear up with fingers. Assemble one pinion mate gear. Rotate gears until pinion mate gear is directly in the center of the small opening of the case. Line up the other pinion mate gear with the gear which has just been assembled. Rotate gears until the holes of pinion mate gears are in direct line with the holes of the differential case.

*Step (14)* After making sure the gears are in alignment, apply a small amount of grease to the new spherical washers. Assemble washers between the gears and case. Also line up the holes of the washers with those of the gears and case. Assemble pinion mate cross shaft, make sure lock pin hole of the shaft is in vertical position and lined up with the lock pin hole of the case.



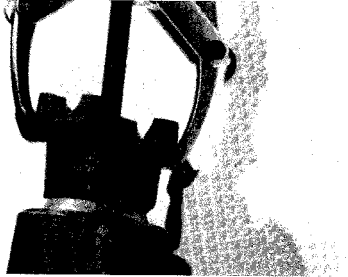
**Figure 3-11**

*Step (15)* Assemble new roll pin. Peen metal of case over pin to lock in place.

## DRIVE PINION REMOVAL

*Step (16)* Secure end yoke or flange with holding wrench, and remove pinion nut and washer. **NOTE:** PINION NUT HAS 500 LBS. FT. (677.9 N·m) MAX. OF TORQUE FOR RETENTION.


TOOL: D-189 holding Wrench  
TM-1000-F Torque multiplier or equivalent  
Long Handle break-over bar (wrench)



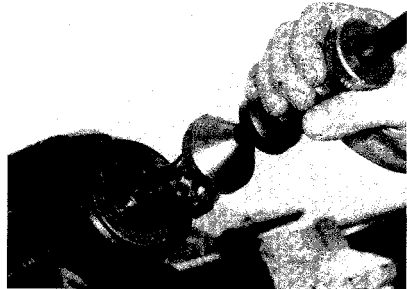
**Figure 3-12**

*Step (17)* Remove end yoke or flange with tools as shown. If end yoke or flange shows wear in the area of the seal contact surface, it should be replaced.

TOOL: L-4534 Yoke Remover (2 Jaw Puller)

 **WARNING:** Gear teeth may have sharp edges. When handling gears, use care to avoid personal injury.

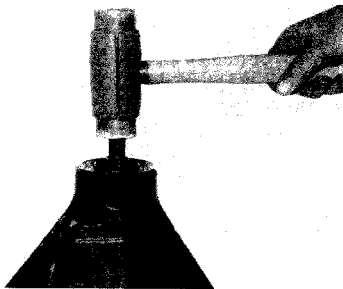
**NOTE**  
On the spline end of the pinion, there are bearing preload shims. These shims may stick to the pinion or bearing or even fall out. These shims are to be collected and kept together since they will be used later in assembly. Try not to mutilate shims. If shims are mutilated, replace with new ones.



**Figure 3-14**

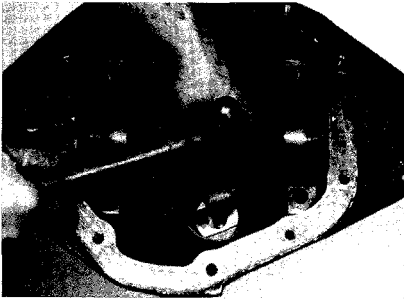
*Step (19)* Pull out pinion seal with puller as shown. Discard seal. **REPLACE WITH NEW ONE AT TIME OF ASSEMBLY.** Remove bearing cone and outer thrust washer.

TOOL: D-131 Slide Hammer.



**Figure 3-13**

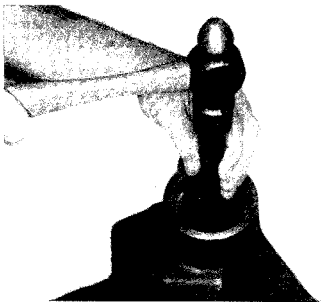
*Step (18)* Remove pinion by tapping with a rawhide or plastic hammer. Catch the pinion with your hand to prevent it from falling and being damaged.



**Figure 3-15**

*Step (20)* Turn nose of carrier down. Remove outer pinion bearing cup. Locate driver on back edge of cup; drive cup out of carrier. **CAUTION: DO NOT NICK CARRIER BORE.**

TOOLS: C-4307 Cup Remover  
C-4171 Handle



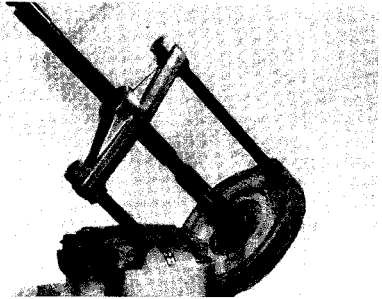
**Figure 3-16**

*Step (21)* Remove the inner bearing cup with tools as shown.

TOOLS: D-159 Cup Remover  
C-4171 Universal Handle

**NOTE**

Shims are located between the bearing cup and carrier bore and may also include an oil baffle, depending upon the application. If shims and baffle are bent or nicked, they should be replaced at time of assembly.



**Figure 3-17**

*Step (22)* Remove pinion bearing with tools as shown.

TOOLS: DD-914-P Press  
DD-914-8 Adapter Ring  
DD-914-95 Adapters



**WARNING:** Do not allow gear to fall. It can strike legs or feet and may cause serious injury. Gear teeth may have sharp edges. When handling, use care to avoid cutting hands.

**RING & PINION GEAR ASSEMBLY THEORY**



**Figure 3-18 (View of ring & pinion set)**

*Step (23)* Ring gears and pinions are supplied in matched sets only. Matching numbers on both the pinion and ring gear are etched for verification. If a new gear set is being used, verify the numbers of each pinion and ring gear before proceeding with assembly.

The nominal distance from the centerline of the ring gear to the button end of the pinion for the Model

80 axle is 3.500 (88.9 mm).

On the button end of each pinion, there is etched a plus (+) number, a minus (-) number, or a zero (0) which indicates the best pinion position for each particular gear set. This dimension is controlled by the shimming behind the inner pinion bearing cup.

For example: If a pinion is etched a plus +3 (m+8), this pinion would require .003 (.08 mm) less shims than a pinion etched "0". This means by removing shims, the mounting distance of the pinion is increased to 3.503 (88.98 mm), which is just what a +3 (m+8) indicates. Or if a pinion is etched -3 (m-8), we would want to add .003" (.08 mm) more shims than would be required if the pinion were etched "0". By adding .003 (.08 mm) shims, the mounting distance of the pinion was decreased to 3.497 inches (88.82 mm) which is just what a -3 (m-8) indicates.

If the old ring and pinion set is to be reused, measure the old shim pack and build a new shim pack to this same dimension. If a baffle is used in the axle assembly, it is considered as part of the shim pack.

To change the pinion adjustments, use different combination of the pinion shims which come in different thicknesses.

**NOTE**

If baffle or slinger is bent or mutilated, it should be replaced.

Measure each shim separately with a micrometer and add together to get total shim pack thickness from the original build-up.

If a new gear set is being used, notice the (+) or (-) etching on both the old and new pinion and adjust the thickness of the new shim pack to compensate for the differences of these two figures.

For example: If the old pinion reads +2 (m+5) and the new pinion is -2 (m-5), add .004" (.10 mm) shims to the original shim pack.

Old Pinion Marking	New Pinion Marking								
	-4	-3	-2	-1	0	+1	+2	+3	+4
+4	+0.008	+0.007	+0.006	+0.005	+0.004	+0.003	+0.002	+0.001	0
+3	+0.007	+0.006	+0.005	+0.004	+0.003	+0.002	+0.001	0	-0.001
+2	+0.006	+0.005	+0.004	+0.003	+0.002	+0.001	0	-0.001	-0.002
+1	+0.005	+0.004	+0.003	+0.002	+0.001	0	-0.001	-0.002	-0.003
0	+0.004	+0.003	+0.002	+0.001	0	-0.001	-0.002	-0.003	-0.004
-1	+0.003	+0.002	+0.001	0	-0.001	-0.002	-0.003	-0.004	-0.005
-2	+0.002	+0.001	0	-0.001	-0.002	-0.003	-0.004	-0.005	-0.006
-3	+0.001	0	-0.001	-0.002	-0.003	-0.004	-0.005	-0.006	-0.007
-4	0	-0.001	-0.002	-0.003	-0.004	-0.005	-0.006	-0.007	-0.008

Figure 3-19 (Pinion Setting Chart - English U.S. Standard)

Old Pinion Marking	New Pinion Marking									
	-10	-9	-8	-7	0	+3	+5	+8	+10	+10
+10	+0.20	+0.18	+0.15	+0.11	+0.10	+0.08	+0.05	+0.03	0	-0.03
+8	+0.18	+0.15	+0.11	+0.10	+0.08	+0.05	+0.03	0	-0.03	-0.05
+5	+0.15	+0.11	+0.10	+0.08	+0.05	+0.03	0	-0.03	-0.05	-0.08
+3	+0.11	+0.10	+0.08	+0.05	+0.03	0	-0.03	-0.05	-0.08	-0.10
0	+0.10	+0.08	+0.05	+0.03	0	-0.03	-0.05	-0.08	-0.10	-0.13
-3	+0.08	+0.05	+0.03	0	-0.03	-0.05	-0.08	-0.10	-0.13	-0.15
-5	+0.05	+0.03	0	-0.03	-0.05	-0.08	-0.10	-0.13	-0.15	-0.18
-8	+0.03	0	-0.03	-0.05	-0.08	-0.10	-0.13	-0.15	-0.18	-0.20
-10	0	-0.03	-0.05	-0.08	-0.10	-0.13	-0.15	-0.18	-0.20	-0.20

Figure 3-20 (Pinion Setting Chart - Metric)

If metric, pinion will be etched (m+ some number). Example (m+5). Use these charts as a guideline to set pinion.

**ESTABLISHING PINION GEAR DEPTH USING SERVICE TOOL GAGES.**



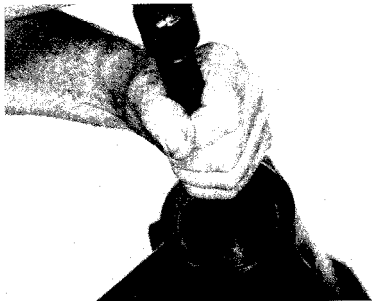
Figure 3-21

View of master pinion bearing, pinion height block, scooter gage, cross arbor, arbor discs and master differential bearings.

**NOTE**

Make sure that all carrier bores are free from all nicks, dirt or any other contamination.

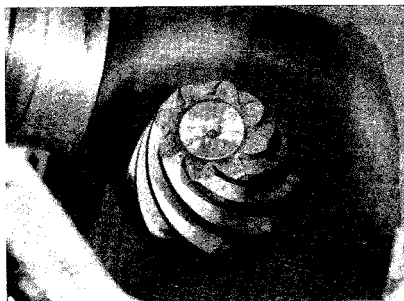




**Figure 3-22**

*Step (24)* Assemble the outer pinion bearing cup into carrier as shown. Make sure cup is seated.

TOOLS: C-4171 Universal Handle  
C-4308 Cup Installer



**Figure 3-24**

*Step (26)* Assemble pinion with master bearing into housing. Assemble outer pinion bearing cone, end yoke, washer, and nut. Torque nut until pinion gear and master bearing is snug (seated) in housing. The pinion gear should not have any end play. **NOTE:** Do not try to rotate pinion using master bearing.



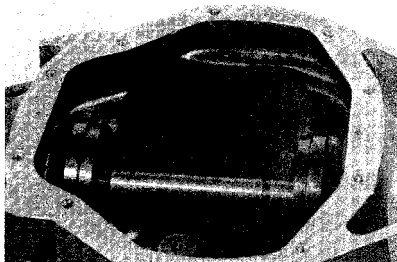
**Figure 3-23**

*Step (25)* Assemble master pinion bearing on pinion.

TOOL: D-391 Master Pinion Bearing



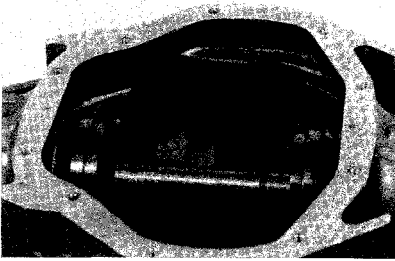
**WARNING:** Gear teeth may have sharp edges. When handling gears, use care to avoid personal injury.



**Figure 3-25**

*Step (27)* Place arbor discs (large diameter) and arbor into cross bores of carrier as shown.

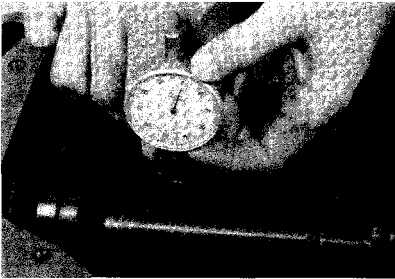
TOOLS: D-116-1 Master Discs  
D-115 Arbor



**Figure 3-26**

*Step (28)* Place pinion height block on top of the button end of the pinion gear and against arbor as shown.

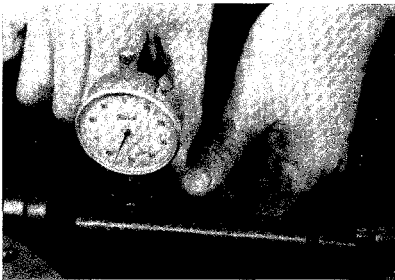
TOOL: D-116-1 Pinion Height Block



**Figure 3-27**

*Step (29)* Place scooter gage on pinion height block. Apply pressure with fingers, making sure the gage is flat on the pinion block. While pressure is applied, set indicator at zero "0".

TOOL: D-115 Scooter Gage



**Figure 3-28**

*Step (30)* Slide scooter gage over arbor. As gage slides

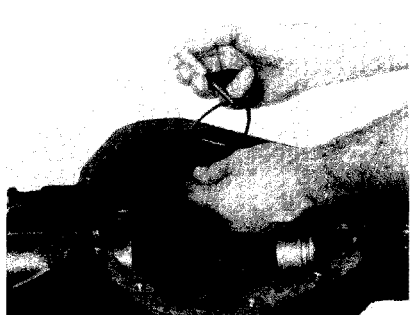
over top of arbor, it will travel in a clockwise direction. When indicator is on center of arbor (on top) it will stop traveling in a clockwise direction. If indicator starts to travel in a counter-clockwise direction, this means you have passed the center (top) of the arbor. Record only the reading when the indicator is at the highest point.

This reading indicates the amount of shims necessary to obtain the shim pack plus (+) or minus (-) the etching on the button end of the pinion.

If the etching is zero (0), the shim pack will remain unchanged.

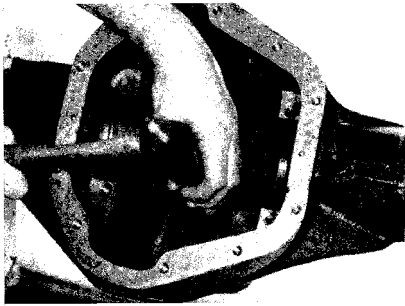
For example: If the pinion is etched +3 (m+8), this pinion would require .003" (.08mm) less shims than a pinion etched zero (0).

If the pinion is etched -3 (m-8), this would require .003" (.08 mm) more shims than a pinion etched zero (0).



**Figure 3-29**

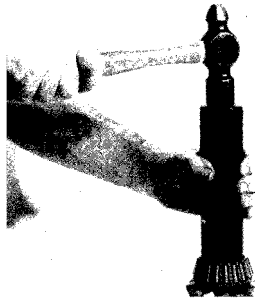
*Step (31)* Measure each shim separately with a micrometer and add together to get total shim pack thickness. If baffle is required it is to be included in the shim pack. If slinger is used between the inner bearing cone and thrust face of pinion, the slinger is also to be measured and included as part of the total shim pack.



**Figure 3-30**

*Step (32)* Place the required amount of shims (and baffle if used) in the inner bearing bore. Drive the inner bearing cup into the carrier. Make sure cup is seated.

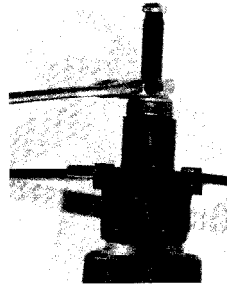
TOOLS: C-4204 Cup Installer  
C-4171 Universal Handle



**Figure 3-31**

*Step (33)* Assemble inner bearing cone (and slinger if used) on pinion. Drive bearing on shaft until it is completely seated.

TOOL: D-389 Bearing Installer



**Figure 3-32**

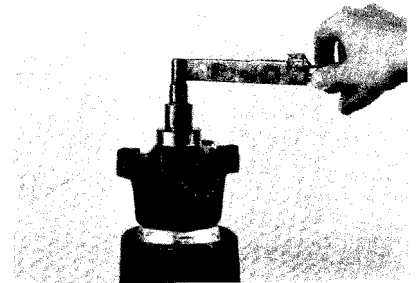
*Step (34)* Assemble pinion into carrier. Assemble outer pinion bearing cone, thrust washer, and end yoke onto pinion spline.

**NOTE**

Do not assemble preload shims or pinion oil seal at this time.

Use yoke installer as shown to assemble end yoke onto spline of pinion.

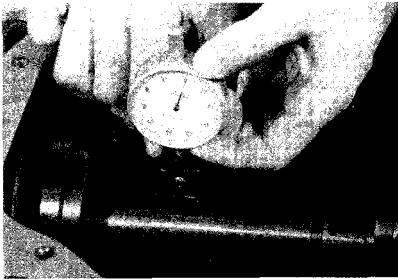
TOOLS: D-191 End Yoke Installer  
D-189 End Yoke Holder



**Figure 3-33**

*Step (35)* Assemble washer and pinion nut. Torque nut until it requires 10 Lbs. in. 1.13 N·m of torque to rotate the pinion. Rotate pinion several times before checking pinion position. This is to seat the bearings and assure a more accurate reading when checking the pinion depth setting.

TOOL: C-193 Lbs. in. Torque Wrench



**Figure 3-34**

*Step (36)* Place arbor and discs (large diameter end) into cross bore of carrier. Place pinion height block on button end of pinion. Set dial indicator on height block (high step of block). Set dial indicator at zero (0). Slide scooter gage across or over arbor.

Indicator will read a plus (+) or minus (-) at its highest point, depending on the etching of the pinion.

**NOTE**

Indicator reading within .002 (.05 mm) of etching is considered acceptable. If pinion position is found to be within specification, continue with build-up. If pinion position is not within specification, change shim pack thickness under inner bearing cup.

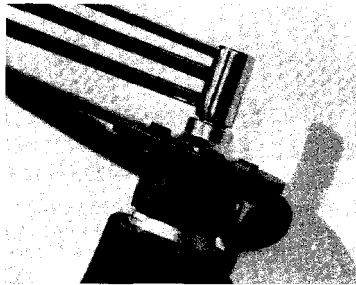
Remove pinion nut, washer, end yoke, and pinion. Assemble preload shims onto pinion. **NOTE:** If old shims are available, measure shim pack and build up new shim pack using new shims of the same thickness. If old shim pack is not available for reference, build shim pack up to .060 (1.52 mm) thick. This will provide a starting point and may require adjustment.



**Figure 3-35**

*Step (37)* Apply a light coat of hypoid lubricant on the lip of pinion seal and assemble into carrier.

**TOOLS:** D-187-A Pinion Seal Installer  
C-4171 Universal Handle

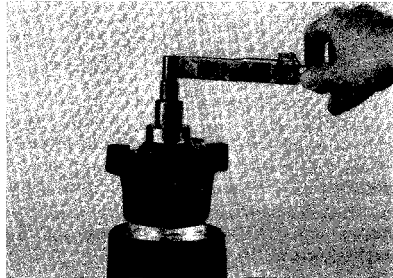


**Figure 3-36**

*Step (38)* Assemble pinion, end yoke, washer, and new pinion nut. Torque nut to specification.

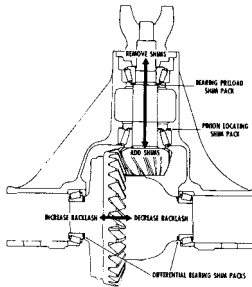
**TOOLS:** D-189 End Yoke Holder  
Torque Wrench

**NOTE:** Torque wrench must be capable of 500 lbs. ft. (677.9 N·m) torque.



**Figure 3-37**

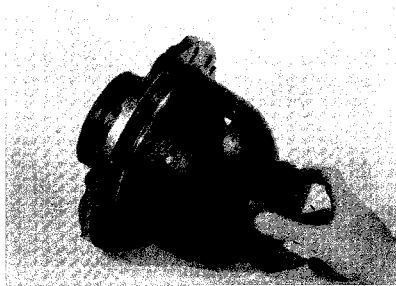
*Step (39)* Using an in. Lbs. torque wrench as shown, rotate pinion. Torque to rotate pinion should be within specification. To increase preload, remove shims, to decrease preload add shims.



**Figure 3-38**

The illustration in figure 3-38 shows the arrow in the pinion pointing in two directions. The direction pointing towards the end yoke indicates that by removing pinion position shims, the distance from the centerline of the axle to the pinion button is increased giving a plus reading. The preload shim pack does not effect the pinion depth setting. Arrows on the ring gear illustrate the method to increase or decrease backlash and differential bearing preload.

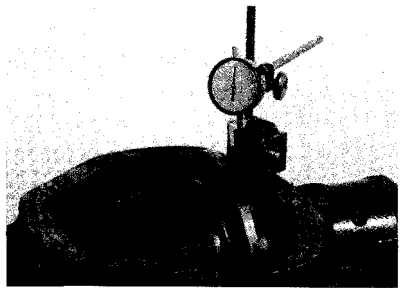
### ASSEMBLY OF DIFFERENTIAL



**Figure 3-39**

*Step (40)* Assemble master differential bearings onto case. Remove all nicks, burrs, dirt etc., from hubs to allow master bearings to rotate freely.

TOOLS: D136/D346 Master Differential Bearings



**Figure 3-40**

*Step (41)* Assemble the differential bearing outboard spacers into the carrier housing, as removed in step 5, figure 3.4.

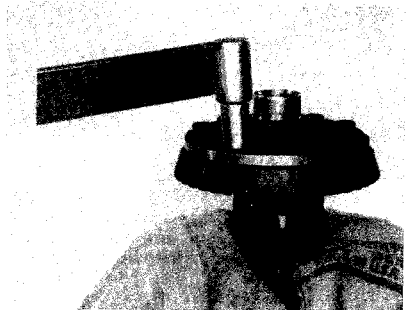
Assemble differential case into carrier (less ring gear). Mount dial indicator with a magnetic base as shown. Locate tip of indicator on flat surface of case. Force differential assembly as far as possible in the direction towards the indicator. With force still applied, set indicator at zero (0).

TOOLS: D-128 Dial Indicator Set

#### NOTE

Dial indicator should have a minimum travel capability of .200 (5.08 mm).

Force the differential assembly as far as it will go in the opposite direction. Repeat these steps until you have obtained the samereading. Record the reading of the indicator on the worksheet, page 3-13. This reading will be measurement "A". After making sure the readings are correct, remove indicator and differential assembly from housing. Remove master bearings from hubs and set aside.

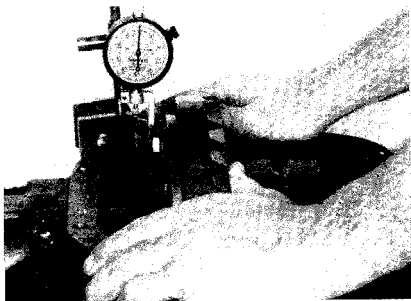


**Figure 3-41**

*Step(42)* Place case assembly in a vise. Besure flange

face of the case is free of nicks or burrs. Assemble ring gear to case. Line up holes of the ring gear with those of the case. Use new ring gear screws. Draw up screws alternately and evenly. Torque ring gear screws to specification.

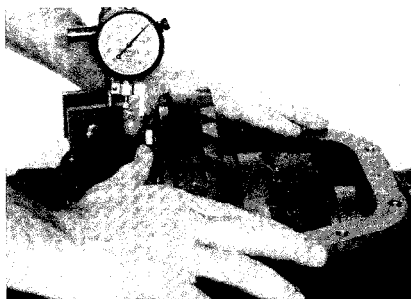
TOOL: Torque Wrench



**Figure 3-42**

*Step (43)* Assemble master differential bearings onto case hubs. Place differential assembly into housing. Set up dial indicator as shown. Locate tip of indicator on flat surface of one of the ring gear screws. Force the differential case assembly (ring gear) away from the pinion gear. With force still applied to the differential case, set indicator at zero "0".

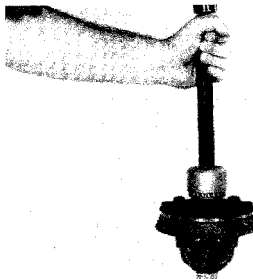
TOOLS: D-128 Dial Indicator Set



**Figure 3-43**

*Step (44)* Force the differential case assembly and ring gear into mesh with the pinion gear. Rock ring gear to allow the teeth of the gear to mesh. Repeat until the same reading is obtained each time. Record this reading on the worksheet, page 313. This reading will be measurement "B". Remove indicator and differential case assembly from the carrier. Remove master differential bearings from the differential case. Refer to the worksheet for

calculating ring gear backlash and differential bearing preload shims, page 313.



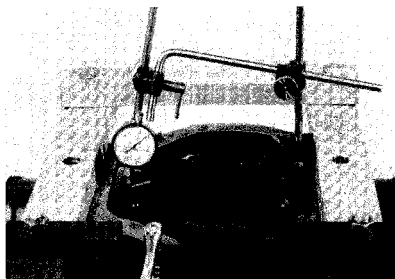
**Figure 3-44**

*Step (45)* Assemble the required amount of shims onto hub (ring gear side) and opposite side as determined using the worksheet. Place bearing cone on hub of case. Use bearing installer to seat bearing cone as shown.

TOOLS: C-4190 Installer  
C-4171 Universal Handle  
DD-914-42 Button

**NOTE**

Button is used to raise case from bench to protect bearing cone cage from being damaged when installing opposite bearing cone.



**Figure 3-45**

*Step (46)* Install spreader and indicator as shown. DO NOT SPREAD CARRIER OVER .015 (.38 mm). Remove indicator.

TOOLS: D-167 Spreader  
D-128 Dial Indicator Set

## WORKSHEET FOR CALCULATING RING GEAR BACKLASH AND DIFFERENTIAL BEARING PRELOAD SHIMS

- (1) Total amount of space measured without ring gear as shown in step 41, figure 3-40 Measurement A \_\_\_\_\_
- (2) Total amount of space measured with gear set assembled in carrier as shown in step 44, figure 3-43 Measurement B \_\_\_\_\_
- (3) Measurement A minus Measurement B equals calculated Measurement C \_\_\_\_\_

After the measurements and calculations have been made, assemble the shim packs using the figures determined in A, B, & C, and adjusting the pack as described below.

### RING GEAR SIDE:

Assemble shim pack to measurement B.

### OPPOSITE SIDE OF RING GEAR:

Assemble shim pack to measurement C. Add .010 (.25 mm) for differential bearing preload and backlash.

## EXAMPLE

- (1) Total amount of space measured without ring gear as shown in step 41, figure 3-40 Measurement A .105" (2.67 mm)
- (2) Total amount of space measured with gear set assembled in carrier as shown in step 44, figure 3-43 Measurement B .065" (1.65 mm)
- (3) Measurement A minus Measurement B equals calculated Measurement C .040" (1.02 mm)

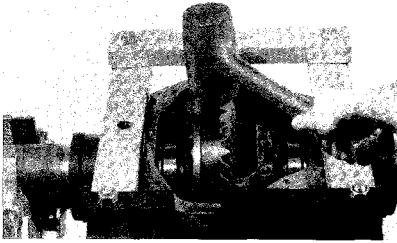
After the measurements and calculations have been made, assemble the shim packs using the figures determined in A, B, & C, and adjusting the pack as described below.

### RING GEAR SIDE:

Assemble shim pack to measurement B. In this example it is .065" (1.65 mm).

### OPPOSITE SIDE OF RING GEAR

Assemble shim pack to measurement C. Add .010 (.25 mm) for differential bearing preload and backlash.  
 $.040" + .010" = .050"$ , ( $1.02 \text{ mm} + .25 \text{ mm} = 1.27\text{mm}$ ).

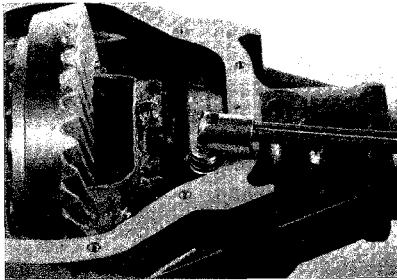


**Figure 3-46**

*Step (47)* Assemble differential bearing cups to differential bearing cones. Install differential assembly into carrier. Use a rawhide or plastic hammer to seat differential assembly into cross bores of carrier. Care should be taken to avoid nicking the teeth of the ring gear and pinion during assembly. Remove spreader.



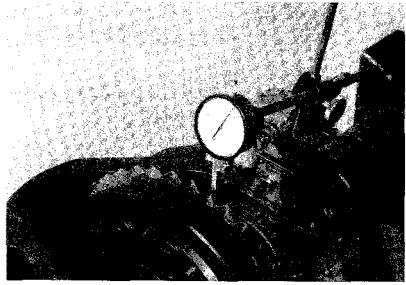
**WARNING:** When differential assembly is installed into carrier, use care to avoid pinching hand or fingers between differential bearing cup and carrier housing. Gear teeth may have sharp edges. When handling gear, use care to avoid cutting hands.



**Figure 3-47**

*Step (48)* Install bearing caps. Make sure the letters stamped on the caps correspond with those on the carrier. Torque bearing cap screws to specification.

TOOLS: Torque Wrench



**Figure 3-48**

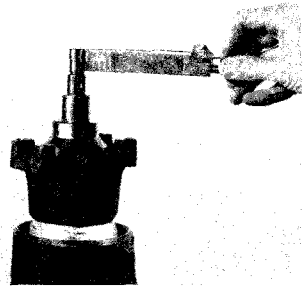
*Step (49)* Check ring gear and pinion backlash in three equally spaced points with dial indicator as shown. Backlash should be within specification and cannot vary more than .002 (.05 mm) between points checked.

TOOLS: D-128 Dial Indicator Set

High backlash is corrected by moving the ring gear closer to the pinion.

Low backlash is corrected by moving the ring gear away from the pinion.

These corrections are made by switching shims from one side of the differential case to the other.



**Figure 3-49**

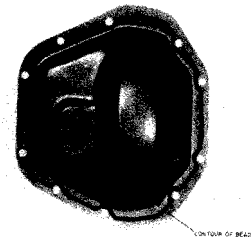
*Step (50)* Using an in. lb. torque wrench as shown, rotate pinion and differential assembly. Torque reading should be within specification. If preload is to high, remove an equal amount of shims from both sides of the differential case hubs. If preload is to low, add an equal amount of shims to both sides of differential case hubs.

**NOTE**

If shims are added to one side only, it will affect backlash reading.



## APPLYING RTV SILICONE GASKET SEALER TO COVER PLATE



**Figure 3-50**

*Step (51)* Apply gasket sealer to cover plate and assemble to carrier. Torque screws to specification.

TOOLS: Torque Wrench

### NOTE

The cover face of the carrier and the flat surface of the cover plate must be free of any oil film or foreign material. Sealant material must meet specifications as described in the specification section of this manual.

Apply sealer to cover plate surface. Ensure that the sealer bead is laid on the inside of the cover screw holes. The bead is not to pass through the holes or outside of the holes.

The bead is to be  $\frac{1}{8}$ " to  $\frac{1}{4}$ " (3.18 - 6.35 mm) high and  $\frac{1}{8}$ " to  $\frac{1}{4}$ " (3.18 - 6.35 mm) wide.

Allow one hour cure time before filling carrier with the proper amount of specified lubricant and vehicle operation.

Assemble axle shafts and wheel end components. Refer to your vehicle service manual for proper wheel bearing setting specification.

## NOTES

## SECTION 4

# SPECIFICATIONS

### DIFFERENTIAL LUBRICATION

It is not our intent to recommend any particular brand or make of lubricant for the Spicer hypoid axle. However, an S.A.E. 80W-90 multi-purpose gear lubricant meeting Mil. Spec. L-2105-C, and suitable for 'A.P.I. Service Classification GL-5, is suggested as a minimum requirement.

#### IMPORTANT

Motor vehicles are operated under various requirements, conditions, and environments. This manual specifies the minimum requirements that the lubricants should meet. However, it is recommended that the lubricants specified by the vehicle manufacturer be used. They may provide additional lubricating characteristics which may be required for your vehicle's operation. Contact your local service dealer or refer to your owner's manual for obtaining the proper lubricant specification.

### AXLE LUBRICANT CHANGE SCHEDULE

The following schedule is a suggested lubricant change schedule. Lubricant in your vehicle may require more frequent changes depending upon the environment in which it is operated in. Contact your local service dealer or refer to your owner's manual for obtaining the proper lubricant change schedule for your vehicle.

Drain lubricant at first oil change and refill with specified lubricant. FOR NORMAL ON HIGHWAY USE, change lubricant every 100,000 miles or 24 months, whichever comes first. FOR OFF HIGHWAY, SANDY, DUSTY, OR WET CONDITIONS, change lubricant every 25,000 miles or 6 months, whichever comes first.

Lubricant may be drained by removing the carrier cover plate. This also allows for visual inspection of the internal components. Follow the service procedure in the manual for reassembly of the cover plate.

### WHEEL BEARING LUBRICATION

Wheel bearings are lubricated by packing with grease. For grease packing it is recommended that a <sup>2</sup>N.L.G.I. No. 2 lithium EP grease suitable for automotive wheel bearings be used. Contact your local vehicle service dealer or refer to your owner's manual for obtaining the proper lubricant specification, and maintenance schedule.

### SUBMERSION OR DEEP WATER FORDING

If the vehicle is exposed to water deep enough to cover the hubs, it is recommended that the wheel ends be disassembled and inspected for water damage and/or contamination.

In the event the carrier housing should become submerged in water, particularly if over the breather, it is recommended that the hypoid gear lubricant be drained and internal parts be inspected for water damage and/or contamination.

Clean, examine, and replace damaged parts if necessary, prior to assembling the housing cover and refilling with the specified hypoid lubricant.

#### NOTE

If the hubs are exposed to deep water, it is possible that the water could enter the carrier at the point the axle shaft enters the tube in the wheel end. This could also necessitate the draining of the hypoid lubricant as described above.

It is recommended that whenever bearings are removed, they be replaced with new ones, regardless of mileage.

<sup>1</sup>A.P.I. - American Petroleum Institute

<sup>2</sup>N.L.G.I. - National Lubricating Grease Institute

# RTV SILICONE RUBBER SEALER SPECIFICATION

Sealant material must meet specification of <sup>1</sup>A.S.T.M. 1, GE 503, Z1, Z2, Z3.

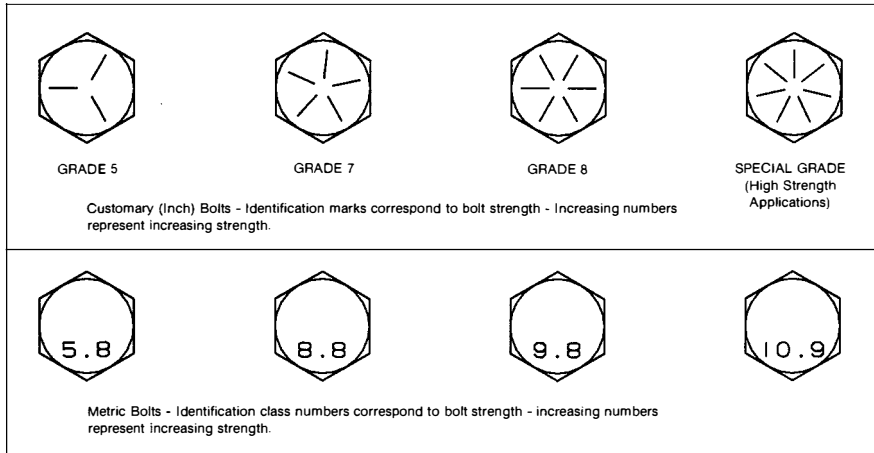
## FASTENER STRENGTH IDENTIFICATION

### IMPORTANT

Whenever fasteners are replaced, it is very important that the fastener be replaced with one of equal or higher grade and quality. Fasteners should be torqued as recommended or specified for the application.

### WARNING

IF FASTENERS OF A LOWER GRADE OR CLASS ARE TORQUED TO THE REQUIREMENTS OF A HIGHER GRADE OR CLASS FASTENER, IT MAY RESULT IN COMPONENT FAILURE. (E.G. GRADE 5 FASTENER TORQUED TO THE REQUIREMENTS OF A GRADE 8 FASTENER).



**Figure 4-1**

Inch grade fasteners can be identified by the radial lines embossed upon the head of the fastener and will correspond to the fastener strength by two-lines less than actual grade (i.e. grade 8 fastener will display 6 radial lines on the head).

Metric fastener strength can be identified with the class identification embossed on the head of each fastener. Increasing numbers represent increasing strength.

## WRENCH TIGHTENING TORQUE SPECIFICATIONS

	LBS. FT.	N•m
Cover Screws .....	35	47.5
Differential Bearing Cap Screws .....	80	108.5
Drive Pinion Nut .....	470	637.2
Fill Plug .....	25	33.9
Ring Gear Screws .....	220	298.3

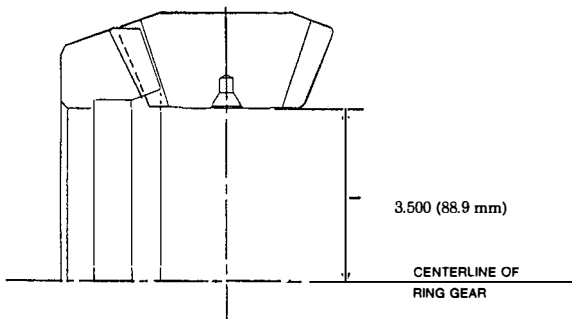
## PINION BEARING AND DIFFERENTIAL BEARING PRELOAD SPECIFICATION

	LBS. IN.	N•m
Torque to Rotate Drive Pinion Only (New bearings only) .....	20-40	2.26 - 4.52
Torque to Rotate Drive Pinion and Differential Case Assembly (Less Axle Shafts) (New bearings only)	SEE NOTE 1	

## BACKLASH SPECIFICATION

Drive Gear to Drive Pinion ..... .005 - .008 (.13 - .20 mm)

## DRIVE PINION GEAR DEPTH SPECIFICATION



**Figure 4-2**

The pinion setting dimension is measured from the centerline of differential carrier (center line of ring gear) to face of pinion (button), plus or minus the etch on the button of the pinion. This dimension must be held within  $\pm .002$  in (.05 mm). For example: The model 80 pinion setting dimension is 3.500 (88.9 mm). If the pinion etch is a +2, this dimension becomes 3.502 (88.95 mm).

## WHEEL BEARING SPECIFICATION

SPECIFIED BY VEHICLE MANUFACTURER. CONTACT YOUR LOCAL VEHICLE SERVICE DEALER OR REFER TO YOUR VEHICLE SERVICE MANUAL FOR OBTAINING THE PROPER WHEEL BEARING SPECIFICATION.

**Notes:**

- (1) Torque to rotate drive pinion only plus 6-8 lbs. in. (.68 - .90 N•m) for ratios 4.63 to 5.13.

# SPICER®



## RING GEAR & PINION TOOTH PATTERN INTERPRETATION

When setting the pinion position, many of the service manuals required a final pinion position check by using gauges that verified the dimension from the center line of the differential carrier (center line of ring gear) to the face of the pinion (button).

This surface (button) is not used on all new gears for verifying the pinion position. The service tools will be used to establish the proper amount of shims required prior to installing the pinion gear. The final pinion position will be verified by using the GEAR CONTACT PATTERN METHOD, as described in this bulletin.

## RING GEAR AND PINION TOOTH CONTACT PATTERN

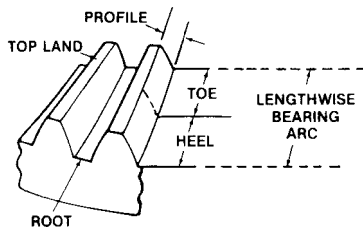


Figure 1 - RING GEAR TOOTH

The TOE of the gear tooth is the portion of the tooth surface at the end towards the center. The HEEL of the gear tooth is the portion of the tooth surface at the outer end. The TOP LAND of a gear tooth is the surface of the top of the tooth. Every gear has a characteristic pattern. The illustrations show typical patterns only, and explains how patterns shift as gear location is changed. When making pinion position changes, shims should be changed in the range of .002 inch (.05 mm) to .004 inch (.10 mm) until correct pattern has been obtained.

When a change in backlash is required, backlash shims should be changed in the range of 1-1/2 times the amount of backlash required to bring the gears into specification. For example, if the backlash needed to be changed by .004 inch (.10 mm), the shim pack should be changed by .006 inch (.15 mm) as a starting point. The actual amount of backlash change obtained will vary depending upon the ratio and gear size.

High backlash is corrected by moving the ring gear closer to the pinion. Low backlash is corrected by moving the ring gear away from the pinion. These corrections are made by switching shims from one side of the differential case to the other.

### NOTE

When making changes, note that two variables are involved. Example: If you have the backlash set correctly to specifications and you change the pinion position shim, you may have to readjust the backlash to the correct specification before checking the pattern. Refer to pattern interpretation.



**WARNING: Gear teeth may have sharp edges.  
When handling gears, use care to avoid personal  
injury.**

## STEPS

- (1) Paint ring gear teeth with a marking compound to both the drive and coast side.
- (2) Rotate ring gear one complete revolution in both directions while load is being applied with a large screwdriver or similar tool between the carrier casting and differential case flange.

## PATTERN INTERPRETATION (RING GEAR)

DRIVE SIDE  
HEEL TOE

COAST SIDE  
TOE HEEL



Normal or desirable pattern. The drive pattern should be centered on the tooth. The coast pattern should be centered on the tooth, but may be slightly toward the toe. There should be some clearance between the pattern and the top of the tooth.



Backlash correct. Thinner pinion position shim required.



Backlash correct. Thicker pinion position shim required.



Pinion position shim correct. Decrease backlash.



Pinion position shim correct. Increase backlash.

## PATTERN MOVEMENTS SUMMARIZED

- (1) Decreasing backlash moves the ring gear closer to the pinion.  
**Drive pattern** (convex side of gear) moves slightly lower and toward the toe.  
**Coast pattern** (concave side of gear) moves lower and toward the toe.
- (2) Increasing backlash moves the ring gear away from the pinion.  
**Drive pattern** moves slightly higher and toward the heel.  
**Coast pattern** moves higher and towards the heel.
- (3) Thicker pinion position shim with the backlash constant moves the pinion closer to the ring gear.  
**Drive pattern** moves deeper on the tooth (flank contact) and slightly toward the toe.  
**Coast pattern** moves deeper on the tooth and toward the heel.
- (4) Thinner pinion position shim with the backlash constant moves the pinion further from the ring gear.  
**Drive pattern** moves toward the top of the tooth (face contact) and toward the heel.  
**Coast pattern** moves toward the top of the tooth and slightly toward the toe.

